

Historic, archived document

Do not assume content reflects current scientific knowledge, policies, or practices.

MICHELL'S SEEDS

1923

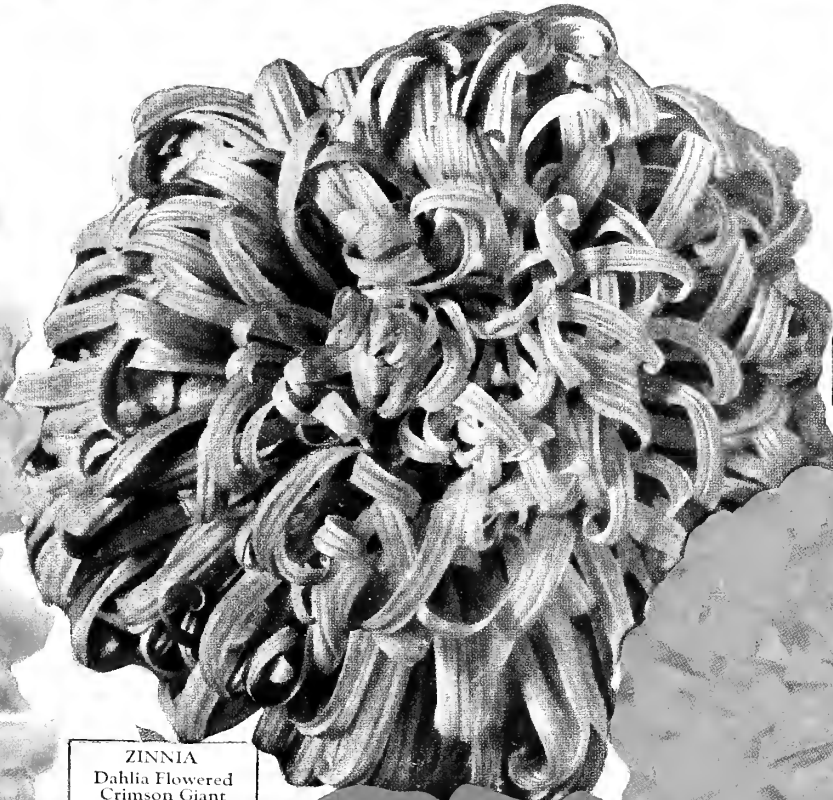

ASTER
California Giant
Purple

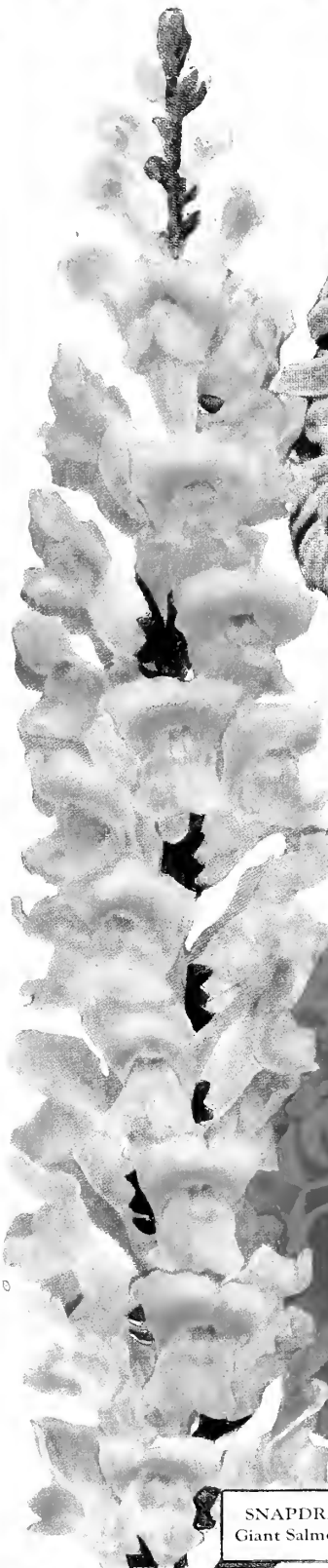

ZINNIA
Dahlia Flowered
Crimson Giant



STRAWFLOWER
Golden Ball



SNAPDRAGON
Giant Salmon Pink



MICHELL'S FLOWER SEED SPECIALTIES

Snapdragon, Michell's Giant Salmon Pink. Pkt. 15c; large pkt. 60c
Aster, California Giant, Purple. Pkt. 25c; large pkt. 75c
Strawflower, Golden Ball. Pkt. 10c; large pkt. 30c; oz. 90c.
Zinnia, Dahlia Flowered, Crimson Giant. Pkt. 25c; large pkt. 75c.

One pkt. each of above for 60c

HENRY F. MICHELL CO., 518-516 MARKET ST. PHILADELPHIA

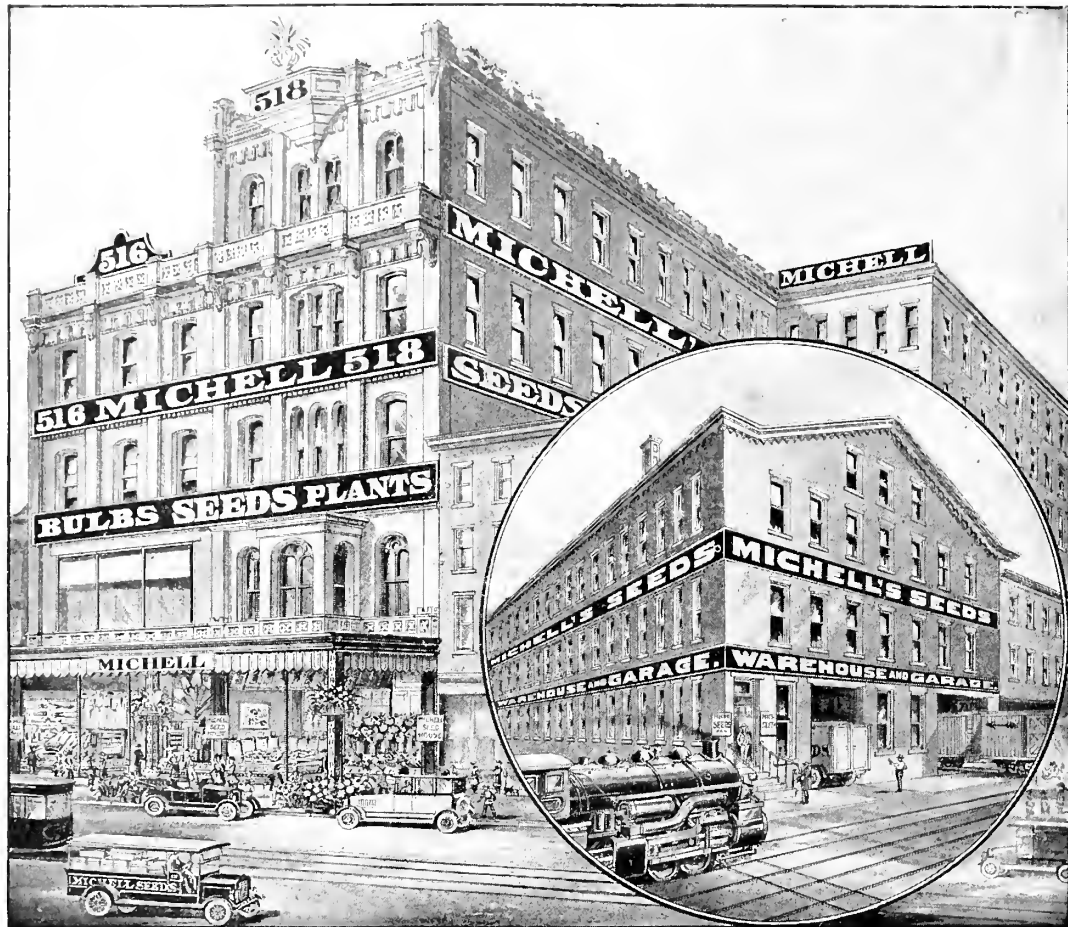

A VIEW OF OUR 518 and 516 MARKET ST., PHILA., ESTABLISHMENTS AND OUR WAREHOUSE WITH R. R. SIDING AT AMERICAN AND DAUPHIN ST. PHILA., BOTH PREMISES ARE ENTIRELY OCCUPIED BY US

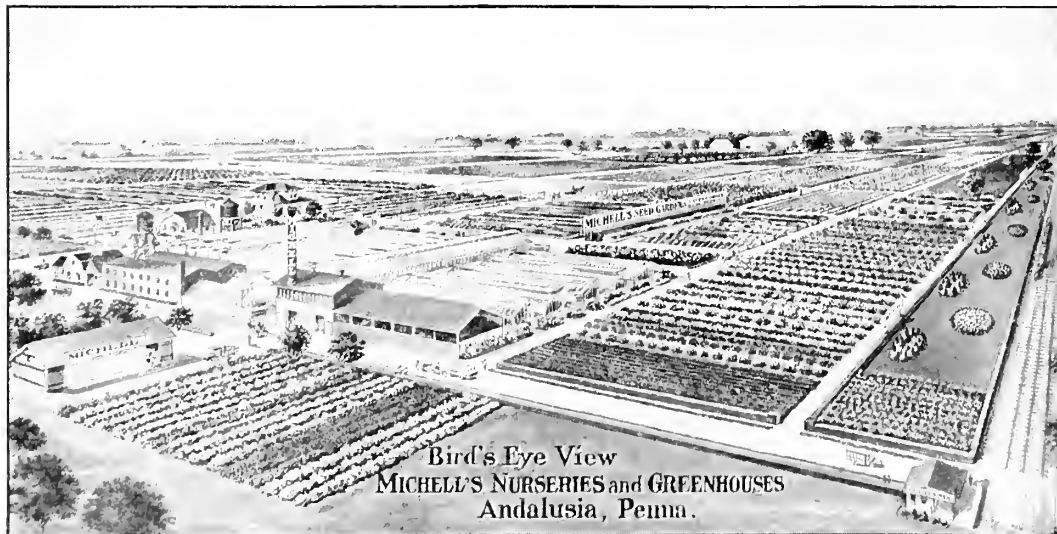

Bird's Eye View
MICHELL'S NURSERIES and GREENHOUSES
Andalusia, Penna.

HENRY F. MICHELL { PRESIDENT
SECRETARY

FRED'K J. MICHELL { VICE-PRESIDENT
TREASURER

HENRY F. MICHELL CO.

SEEDS BULBS PLANTS GARDEN SUPPLIES FERTILIZERS
INSECT DESTROYERS POULTRY SUPPLIES ETC.

WAREHOUSES { 509-11-13 LUDLOW ST.
AMERICAN AND DAUPHIN STS. 518-516 MARKET ST., PHILA.

BELL AND KEYSTONE
TELEPHONES

NURSERIES AND PLANT HOUSES, ANDALUSIA, PA.

DIRECTIONS FOR ORDERING (SUGGESTIONS) 1

CONDITIONS OF SALE

All contracts, sales and acknowledgments of orders are contingent upon crop failures, partial deliveries by growers or manufacturers, strikes, or other unavoidable causes beyond our control; also unsatisfactory credit standing. All quotations are subject to market changes and goods being unsold on receipt of order. Henry F. Michell Co. give no warranty, expressed or implied, as to the description, purity or productiveness of any seeds, plants or bulbs they send out, and they cannot be in any way responsible for the crop. If the customer does not accept the goods on these terms, they can be returned at once and no sale has been made. No responsible seedsman can give a warranty.

PLEASE ORDER EARLY

We shall greatly appreciate it if our customers will adopt our suggestion to send us their orders for **seeds, plants, bulbs, etc.**, during January and February. Shipment need not be made until you want the goods.

PACKING CHARGES

No charges is made for boxes or packing, except for two-bushel seamless sacks which are charged at market value; these bags are returnable for credit at the price charged. Any extra charges over actual postage on Parcel Post orders is for extra packing required.

BUSINESS TERMS

We especially invite charge accounts, which is more convenient than to remit for each order at the time it is sent us. When sending your first charge order, please send us the names and addresses of two or more business houses with whom you have had past or present credit relations; this saves considerable time in the execution of your first charge order.

As to our responsibility, we refer you to **Dun's or Bradstreet's Mercantile Agency**, or any bank or trust company in the United States.

REGARDS C. O. D. SHIPMENTS

Goods can be sent C. O. D. (with the exception of perishable items, which include plants and cold storage bulbs; these cannot be sent C. O. D.). No C. O. D. shipments for any kind of goods can be made by express or freight out of town unless a partial remittance accompanies the order. No C. O. D. orders where the amount is less than 50c., except in the following zone in Philadelphia: Market Street Ferry to Sixteenth Street, Pine Street to Vine Street, C. O. D. orders outside of this zone in our delivery limits must amount to \$1.00 or more. During April and May, owing to the heavy volume of business transacted, we are not in a position to accept orders for shipment C. O. D. unless a partial payment has been made on account.

SHIPPING INSTRUCTIONS

Always state by what method you want goods forwarded, otherwise we will ship according to our best judgment.

FORWARDING SERVICE

We deliver, postpaid to any Post Office in the United States, Vegetable and Flower Seeds in packets, ounces, and pounds, except where otherwise noted in the Catalogue. If these are wanted by parcel post, please remit for postage at the rates quoted in table opposite. Agricultural Seeds, Implements, Fertilizers, and other heavy and bulky goods are sent by Express or Freight at purchaser's expense.

Plant orders should be separated from Seed orders, as they will usually be filled and shipped separately.

All Plants, Roots and Bulbs are forwarded by Express (or parcel post when possible) purchaser paying charges.

For those of our customers who prefer to receive such goods by Parcel Post, we will be pleased to forward in this manner such plants as can be sent in this way at the following additional cost, which must be added to the value of each order for Plants, Roots or Bulbs.

To all points east of the Mississippi River, 10 per cent. extra to cover postage and packing charges.

To all points west of the Mississippi River, 20 per cent. extra.

Poisons cannot be sent by Parcel Post; please consult parcel post table below, for rates on other merchandise.

SAFE ARRIVAL—We guarantee the safe arrival of all goods sent to points within the United States except when shipped to points where there is no express or freight agent.

LOCAL DELIVERY.—Our automobile services covers most of Philadelphia, free delivery being confined to the following districts bounded as follows:

East. Delaware Ave., in central downtown. Front St., uptown.

North. Olney Ave. in the Old York Road district.

North. City Line in the Germantown and Chestnut Hill district.

Northwest. City Line in the Bala, Cynwyd, Wynnefield and Overbrook district.

West. 69th Street.

South. Shunk St. from Front to 69th St.

Ridge Ave. District. 35th and Lehigh Ave.

Please note the free delivery service does not include bulky quantities of fertilizers in over ¼ ton quantities. Special arrangements can however be made for delivery of these.

Shipment of goods can also be made by package service from Market and Chestnut St. Ferries, Broad St. Station, Reading Terminal and B. & O. R. R., at 24th and Chestnut Sts.

The tariff for shipments that can be made by this method on merchandise they will receive packed in one piece is as follows:

10 lbs. and under, 12c.	25 lbs. to 40 lbs., 24c.
10 lbs. to 25 lbs., 18c.	40 lbs. to 55 lbs., 30c.

Shipments weighing more cannot be sent via Package Service.

Positions for Gardeners, Estate Superintendents, etc.

Frequently we have on our register the names of competent Gardeners, Superintendents, Greenskeepers, Coachmen, Farmers and Poultrymen who desire positions. We are always pleased to put them in communication with parties desiring services of such men. We are careful to recommend only reliable persons, and there is absolutely no charge for this service to employer or the one employed. Frederick J. Michell, Jr., is in charge of this department.

PARCEL POST RATES FROM PHILADELPHIA

United States Parcel Post Rates (Seeds, plants and bulbs included)	First pound or fraction	Each additional pound or fraction	Packages must not exceed 84 inches (length and girth combined)
Local Rate, Philadelphia.....	\$0.05	\$0.00½	Limit of weight this zone, 70 lbs.
1st Zone, within 50 miles of Philadelphia.....	.05	.01	Limit of weight this zone, 70 lbs.
2d Zone, over 50 and under 150 miles.....	.05	.01	Limit of weight this zone, 70 lbs.
3d Zone, over 150 and under 300 miles.....	.06	.02	Limit of weight this zone, 50 lbs.
4th Zone, over 300 and under 600 miles.....	.07	.04	Limit of weight this zone, 50 lbs.
5th Zone, over 600 and under 1000 miles.....	.08	.06	Limit of weight this zone, 50 lbs.
6th Zone, over 1000 and under 1400 miles.....	.09	.08	Limit of weight this zone, 50 lbs.
7th Zone, over 1400 and under 1800 miles.....	.11	.10	Limit of weight this zone, 50 lbs.
8th Zone, over 1800 miles.....	.12	.12	Limit of weight this zone, 50 lbs.

All small Parcel Post packages, weighing 8 ounces or less can be sent at the special rate of 1 cent for each 2 ounces or fraction to all parts of the United States. (Over 8 ounces must be sent at Parcel Post rates.) On shipments weighing 20 lbs. or more it is usually cheaper to ship by express.

Kindly Remit for Postage when it is necessary to avoid delay in filling and shipping your order.

HENRY F. MICHELL CO.

518-516 Market St., Phila., Pa.

VEGETABLE SEEDS	
	Page
Anise	8, 36
Artichoke	8
Asparagus	8
Basil (Sweet)	12, 33, 36
Beans (Sweet)	4, 9 to 11
Beet	4A, 12
Borage	12, 36
Broccoli	12
Brussels Sprouts	12
Cabbage	14, 15
Cantaloupe	5, 24
Caraway	15, 36
Carrot	13, 45
Catnip	15, 36
Cauliflower	15, 36
Celery	16
Celery	4A, 16
Chamomile	16, 36
Chervil	13, 23
Chicory	13
Chives	13, 36
Citron	16, 25
Collards	13
Coriander	13, 36
Corn Salad	19
Corn (Sugar)	4A, 18, 19
Corn (Pop)	19
Cress (Garden)	17
Cress (Water)	17
Cucumber	17
Dandelion	20
Dill	20, 36
Egg Plant	20
Endive	20
Fennel	20, 36
Garden Cress	17
Garlic	20, 26
Gumbo	26
Herbs (Seed)	36
Hop Vine	20
Horse Radish	20
Kale	21
Kohl Rabi	21
Lavender	21, 36
Leek	21
Lettuce	5, 22, 23
Martynia	21
Mangel Wurzel	25, 47
Melons	5, 24, 25
Mint	21, 36
Mushroom Spawn	6, 26
Mustard	24
Okra	26
Onions	5, 27
Onion Sets	26
Parsley	30
Parsnip	30
Peanuts	31
Peas	5, 28, 29
Pennyroyal	31, 36
Pepper	6, 30
Pe-Tsai	14, 15
Pop Corn	19
Potatoes	31
Potato Seed	31
Pumpkin	32
Radish	7, 32
Rhubarb	33
Rosemary	33, 36
Ruta Baga	33, 36
Saffron	33, 36
Sage	33, 36
Salsify	33
Savory	33, 36
Shallots	26
Sorrel	33
Spinach	7, 33
Squash	34
Sugar Corn	4A, 18, 19
Sweet Basil	12, 33, 36
Sweet Marjoram	33, 36
Swiss Chard	12, 34
Thyme	34, 36
Tobacco	34
Tomato	7, 35
Turnip	36
Water Cress	17

FARM, GRASS AND MISCELLANEOUS SEEDS	
	Page
Alfalfa	43
Barley	45
Beans (Soja)	45
Bird Seeds	187
Broom Corn	46
Buckwheat	45
Canada Peas	48
Carrots	45
Clover	43
Corn (Field)	44
Cotton Seed	46
Cow Peas	48
Emmer	49
Flax	46
Grass Seeds	38 to 41 incl
Hubam Clover	43
Kaffir Corn	45
Kudzu Roots	46
Mangel Wurzel	47
Millet	46
Oats	47
Rape Essex	48
Rye	48
Soja Beans	45
Speltz	49

FARM, GRASS AND MISCELLANEOUS SEEDS-Con.	
	Page
Sudan Grass	49
Sugar Cane	48
Sunflower	49, 187
Timothy	49
Vetches	49
Wheat	49

FLOWER SEEDS	
	Page
Abutilon	57
Achillea	57
Aconitum	57
Acerolinium	72
African Daisy (Aretotis)	59
Ageratum	57
Agrostemma	57
Alyssum	52, 58
Amaranthus	58
Ampelopsis	58
Anchusa	58
Anemone	58
Anthemis	58
Antirrhinum	52, 58
Aquilegia	59
Arabis	59
Arctotis	59
Artemisia	59
Arundo (see Grasses)	74
Asparagus	59
Asperula	59
Asters	52, 53, 60 to 62
Auricula	63
Avena (see Grasses)	74
Baby's Breath (Gypsophila)	74
Bachelor's Button (Centauria)	67
Bachelor's Button (Gomphrena)	72
Balloon Vine	63
Balsam	63
Balsam Apple	63
Baptisia	63
Bartonia	63
Beans (Runner)	63
Begonia	63
Bellflower (Campanula)	63
Bellflower (Platycodon)	85
Bellis (Daisy)	70
Blanket Flower (Gaillardia)	73
Blue Lace Flower	53, 70
Bocconia	63
Botanical and Common Names of Flowers	50
Brachycome	63
Briza (see Grasses)	74
Bromus (see Grasses)	74
Browallia	64
Butterfly Flower (Schizanthus)	55, 88
Calceolaria	64
Calendula	64
California Poppy (Eschscholtzia)	72
Calliopsis	64
Campanula	65
Canary Bird Vine	65
Candytuft	65
Canna	65
Canterbury Bell (Campanula)	65
Cardinal Climber	53, 66
Carnation	66
Castor Beans (Ricinus)	86
Celosia	53, 54, 66
Centaurea	67
Cerastium	67
Chinese Woolflower	54, 66
Chrysanthemum	54, 67
Chryseraria	68
Clarkia	68
Clematis	68
Cleome	68
Cobaea	68
Cockscomb (Celosia)	66
Coix (see Grasses)	74
Coleus	68
Collections of Flower Seeds	51
Columbine (Aquilegia)	59
Cone Flower (Rudbeckia)	59
Convolvulus	68
Corcopsis (Calliopsis)	64
Cornflower (Centaurea)	67
Cornflower Aster (Stokesia)	91
Cosmos	54, 69
Cosmoslip (Primula)	85
Cultura Leaflets	59
Cuphea	69
Cyclamen	69
Cyperus	69
Cypress Vine	70
Dahlia	70
Daisy	70
Datura	70
Delphinium	70
Dianthus	71
Dianthus Barbatus (Sweet William)	91
Dictamnus	71
Didiscus	53, 70
Digitalis	71
Dimorphotheca	71
Dolichos	72
Dracena	72
Dusty Miller (Centaurea)	67
Dusty Miller (Cineraria)	68
Echinocystis	72

FLOWER SEEDS-Con.	
	Page
Eschscholtzia	72
Eulalia (see Grasses)	74
Eupatorium	73
Euphorbia	73
Everlastings	72
Fern Spores	72
Feverfew	73
Forget-Me-Not (Myosotis)	55, 78
Four O'clock (Marvel of Peru)	78
Foxglove (Digitalis)	71
Gaillardia	73
Gas Plant (Dictamnus)	71
Gentiana	73
Geranium	73
Gerbera	73
Geum	73
Globe Amaranth (Gomphrena)	72
Gloxinia	73
Godetia	72
Gomphrena	72
Gourd	73
Grasses, Ornamental	74
Grevillea	74
Gynerium (see Grasses)	74
Gypsophila	74
Helanium	74
Helianthus (Sunflower)	91
Helichrysum	72
Heliopsis	74
Heliotrope	74
Hesperis (Sweet Rocket)	91
Heuchera	74
Hibiscus	74
Hollyhock	74
Honesty	75
Hop Vine (Humulus)	75
Hordeum (see Grasses)	74
Humulus	75
Hunnemannia	75
Hyacinth Bean (Dolichos)	72
Iberis (Candytuft)	65
Ice Plant (Mesembryanthemum)	77
Impatiens	75
Ipomoea	75
Iris	75
Japanese Hop (Humulus)	75
Japanese Ivy (Ampelopsis)	58
Jerusalem Cherry (Solanum)	87
Job's Tears (Coix)	74
Kenilworth Ivy	75
Kochia	76
Kudzu Vine (Pueraria)	85
Lady Slipper (Balsam)	63
Lantana	76
Larkspur (Annual)	76
Larkspur (Perennial)	70
Lathyrus	76
Lavender	76
Lemon Verbena	92
Leptosyne	76
Linaria	55, 76
Linaria (Kenilworth Ivy)	75
Linum	76
Lobelia	76
Love-in-a-Mist (Nigella)	80
Lunaria (Honesty)	75
Lupinus	77
Lychnis	77
Marigold	77
Marvel of Peru	78
Mathiola	77
Matricaria (Feverfew)	73
Maurandia	77
Mesembryanthemum	77
Mexican Fire Plant (Euphorbia Heterophylla)	73
Mignonette	78
Mimosa (Sensitive Plant)	87
Mimulus	78
Mixed Seed for Wild Garden	92
Momordica (Balsam Apple)	63
Monkshood (Aconitum)	57
Moon Flower (Ipomoea)	75
Morning Glory (Convolvulus)	68
Mourning Bride (Scabiosa)	87
Musa Ensete	78
Musk Plant (Mimulus)	78
Myosotis	55, 78
Nasturtium	79, 80
Nemesia	80
Nicotiana	80
Nierembergia	80
Nigella	80
Ornamental Grasses	74
Pansy	81
Papaver (Poppy)	84
Pelargonium (Geranium)	73
Pennisetum (see Grasses)	74
Pentstemon	81
Periwinkle (Vinca)	92
Petunia	55, 82
Phlox	83
Physostegia	83
Pinks (Carnation)	66
Pinks (Dianthus)	71
Platycodon	83
Polyanthus	83
Poppy	55, 84
Portulaca	85
Pot Marigold (Calendula)	64
Primula	55, 85
Pueraria	85

FLOWER SEEDS-Con.	
	Page
Pyrethrum	86
Reseda (Mignonette)	78
Rhodanthe	72
Ricinus	86
Rock Cress (Arabis)	59
Rudbeckia	86
Salpiglossis	86
Salvia	55, 87
Saponaria	87
Scabiosa	87
Scarlet Flax (Linum)	76
Scarlet Runner Bean	63
Scarlet Sage (Salvia)	55, 87
Schizanthus	55, 88
Sensitive Plant	87
Shamrock	87
Shasta Daisy (see Chrysanthemum)	67
Smilax	87
Snappdragon (Antirrhinum)	52, 58
Snow in Summer (Cerastium)	67
Snow on the Mountain (Euphorbia Var.)	73
Solanum	87
Spider Plant (Cleome)	68
Stachys	88
Stavia	88
Stipa (Grasses)	74
Stocks	88
Stokesia	91
Strawflower (Helichrysum)	72
Sunflower (Helianthus)	91
Sweet Alyssum	52, 58
Sweet Peas	89, 90
Sweet Rocket	91
Sweet Sultan	91
Sweet William	91
Tagetes	91
Thalictrum	91
Thunbergia	91
Torenia	91
Transvaal Daisy (Gerbera)	73
Tropaeolum (Nasturtium)	79, 80
Valeriana	92
Verbena	92
Veronica	92
Vinca	92
Viola	92
Violet	92
Wallflower	93
Wild Cucumber (Echinocystis)	72
Wild Flower Garden Mixture	92
Woolflower	54, 66
Xeranthemum	72
Zinnia	56, 93

BULBS AND PLANTS	
Acanthus	116
Achillea	116
Achyranthes	108
Aconitum	116
Ageratum	108
Agrostemma	117
Akebia	134
Almond, Flowering	137
Alternanthera	108
Althaea (Rose of Sharon)	137
Alyssum	108, 117
Amarylils	104
Ampelopsis	134
Amsonia	117
Amygdalus (Almond)	137
Anchusa	117
Anemone	117
Anthemis	117
Antirrhinum	108
Apples	145
Apricots	145
Aquilegia	117
Arabis	117
Arbor Vitae	140
Aristolochia	134
Armeria	119
Artemisia	118, 119
Artichoke	8, 37
Asclepias	119
Ash, Mountain	141
Asparagus	4, 8, 37, 108
Aspidistra	108
Asters	108, 118
Astilbe	119
Aubretia	119
Baby's Breath	124
Baptisia	119
Barberry	136, 137
Beech	141
Begonias	104, 108
Bellis (Daisy)	108, 119
Berberis	136, 137
Bignonia	134
Birch	141
Blackberries	142
Bocconia	119
Boltonia	119
Boxwood	136
Bridal Wreath (Spirea)	138
Brussels Sprouts	12, 37
Buddleia	137
Butterfly Bush	137
Cabbage	15, 37
Caladium	105
Calendula	108
California Privet	136

BULBS AND PLANTS-Con.	
	Page
Callas	105
CalliCARPA	137
Calycanthus	137
Campanula	120
Candytuft (Hardy)	125
Cannas	95
Carnations	119
Caryopteris	120
Cassia	120
Catalpa	141
Cauliflower	15, 37
Celastrus	134
Celery	16, 37
Centaurea	120
Cerastium	120
Cercis (Judas or Red Bush)	137
Chaste Tree	139
Chelone	120
Cherries	145
Chionanthus (White Fringe)	137
Chives	13, 23, 37
Chrysanthemum	121
Cimicifuga	120
Cinnamon Vine	135
Clematis	120, 134
Clethra (Pepper Bush)	137
Climbing Plants	134, 135
Cobaea	135
Coleus	108
Collections Hardy Perennials	137
Columbine	117
Coreopsis	120
Cornus (Dogwood)	137
Coronilla	120
Cosmos	108
Crab	138, 141
Cranberry	139
Currants	142
Cypress	140
Cytisus (Golden Chain)	137
Dahlia	96 to 100
Daisy	108, 119
Delphinium	122
Deutzia	137
Dianthus	122
Dictamnus	122
Dielytra	122
Digitalis	122
Dogwood	137
Dracena	108
Echinops	123
Egg Plant	20, 37
Elm	141
Epimedium	123
Eryngium	123
Eupatorium	123
Euphorbia	123
Evergreens	140
Evonymous	135, 138
Exochorda	138
Ferns	108, 123
Feverfew (Matricaria)	127
Forget-Me-Not	109, 128
Forsythia (Golden Bells)	138
Foxglove	122
Funkia	123
Gaillardia	123
Geraniums	108
Geum	123
Gillenia	124
Gladiolus	101, 102
Globe Flower	132
Gloxinias	105
Globe Bells	138
Golden Chain	137
Gooseberries	142
Grapes	143
Grasses (Ornamental)	124
Gypsophila	124
Hedge Plants	136
Helanium	124
Helianthemum	124
Helianthus	125
Heliopsis	124
Hemierocallis	125
Heuchera	124
Hibiscus	125
Hollyhock	125
Honeysuckle	135, 138
Horse Chestnut	141
Hop Vine	

BULBS AND PLANTS—Con.		BULBS AND PLANTS—Con.		IMPLEMENTS, SUNDRIES, ETC.—Con.		IMPLEMENTS, SUNDRIES, ETC.—Con.		IMPLEMENTS, SUNDRIES, ETC.—Con.	
	Page		Page		Page		Page		Page
Linum	127	Trillium	132	Cyanegg	188	Lawn Signs	173	Salt Bricks	181
Lobelia	109, 127	Tritoma	132	Dalmatian Powder	188	Lawn Sprinklers	169, 171	Sand	176
Lonicera	138	Trolius	132	Dandelion Extractor	158	Lawn Trimmers	153	Sash	174
Lupinus	127	Tuberose	107	Dandelion Rake	158	Leaf Mould	176	Saucers	186
Lychnis	127	Tulip Tree	141	Dibbles	160	Leaf Racks	150	Saw Horse	164
Lycium	135	Tunica	132	Digging Forks	160	Lemon Oil	188	Saws	163
Lycoris	106	Umbrella Tree (Catalpa)	141	Disinfectants	185	Lime	191	Scalegide	189
Lysimachia	127	Valeriana	132	Dock Lifter	158	Limestone	191	Scale Destroyer	189
Lythrum	127	Verbascum	133	Dried Blood	190	Lime Sulphur	188	Scissors	174
Madeira Vine	106, 135	Vegetable Plants	37	Drills	147 to 149	Liquid Manure Distributor	169	Scoops	147
Magnolia	141	Yerba	109	Dusters	177	Lopping Shears	163	Scrapers	160, 161
Malus (Crab)	138, 141	Yerbanica	133	Edgers	153, 157	Mag-O-Tite	189	Screw Drivers	161
Maples	109	Viburnum	139	Egg Boxes	180	Manure	190, 191	Scuffle Hoe	159
Marigold	127	Vinca	109, 133	Emery	155	Manure Drags	159	Scythes	155
Matricaria	127	Viola	133	Extension Pipes	179	Manure Forks	160	Scythe Snathes	155
Mertensia	127	Vitex	139	Farmogerm	42, 190	Marking Pencils	178	Scythe Stones	155
Mexican Vine	106, 135	Wallflower	133	Fenders	180	Marking Rake	156	Seeders	147 to 149
Mint	21, 37	Weeping Willow	141	Fencing	166, 167	Mastic	170	Seed Pans	186
Mock Orange	138	Weigela	139	Fern Dish Liners	186	Mastic Machine	170	Shaderine	176
Monarda	128	White Fringe	137	Fern Fans	186	Masticote	170	Shading Cloth	174
Montbretia	106	Wistaria	135	Fertilizers	8, 190, 191	Mats	174	Shears	157, 162, 163
Moon Vine	135	Yews	140	Fertilizer Distributors	146, 147	Mattocks	166	Sheep Manure . 3rd cover	191
Mountain Ash	141	Yucca	133	Files	155	Measures	161	Shoo Fly	189
Mulberry	141	Zephyranthes	107	Fish Oil Soap	188	Mehler Handy Tools	160	Shovels	159
Myosotis	109, 128	Zinnia	109	Flower Bed Fencing	167	Melon Nets	24	Sickles	159
Nierembergia	128			Flower Pots	186	Melrosine	189	Sieves	164
Oak	141			Flower Scissors	174	Miniature Hotbeds	174	Single Trees	146
Oenothera	138			Flysoan	188	Mole Traps	157	Slug Shot	189
Oxalis	107			Forks	160	Mo-Lo	189	Snow Shovels	159
Pachysandra	128	IMPLEMENTS, SUNDRIES, ETC.		Formaldehyde	47	Monkey Wrenches	161	Soap Spray	189
Paeonies	129	Alphano, Inoculant	42, 190	Fruit Pickers	165	Moss	176	Sod Crushers	164
Palms	109	Ant Exterminator	188	Fruit Presses	165	Mouse Traps	164	Sod Cutter	155
Pandanus	109	Anti-Clover Fertilizer	190	Pumigators	177	Mowers	151 to 155	Sod Lifters	150
Pansy	109	Aphine	188	Garden Line	161	Mulford Germ	42, 190	Sod Performators	150
Pardanthus	128	Aphis Pank	188	Garden Rakes	158	Muriate of Potash	191	Sod Tamper	150
Parsley	30, 37	Aprons	169	Garden Reels	161	Netting	166	Soil	176
Passiflora	109	Arsenate of Lead	188	Garden Tool Sets	159	Nico Fume	189	Soot	176
Peaches	145	Ashes	190	Getz There Soap	188	Nico Fume Tobacco Powder	189	Spades	159
Pearl Bush	138	Asparagus Bunchers	8, 161	Glass Clamps	170	Nicotine	189	Spading Forks	160
Pears	145	Asparagus Fertilizer	8, 190	Glass Cleaner	176	Nitrate	189	Sparrow Trap	187
Pentstemon	128	Asparagus Knives	8, 161	Glass Cutters	170	Nitrate of Soda	191	Sprayers	169, 178, 179
Pepper	30, 37	Asparagus Salt	8	Glazing Cement	170	Nozzles	169, 179	Sprinklers	169, 171
Pepper Bush	137	Asparagus Tape	8, 161	Glazing Points	170	Nozzle Holder	168	Stakes	175
Perennials	116 to 133	Auto Heaters	173	Gloves	162	Oat Sprouter	181	Stake Fasteners	175
Petunia	109	Axes	161	Grafting Tool	164	Oil Cans	155	Staples	176
Philadelphus (Mock Orange)	138	Bacteria	42, 190	Grafting Wax	164, 176	Orchid Baskets	186	Stim-U-Plant	191
Phlox	109, 129, 130	Bamboo Poles	175	Grape Bags	165	Orchid Pans	186	Strainers	179
Physalis	128	Bark	172	Grape Dust	188	Orchid Peat	176	Sulco-V. B.	189
Physostegia	128	Barrels	150	Grape Grinder	165	Paeony Support	166	Sulphate of Ammonia	191
Picea (Spruce)	140	Barrel Trucks	150	Grape Scissors	174	Paper	174	Sulphate of Copper	189
Pinks	119, 122, 128	Baskets	157, 166	Grass and Grain Fertilizer	190	Paris Green	189	Sulphate of Potash	191
Pinus	140	Basket Hooks	173	Grass Catcher	152	Paris Green Shakers	177	Sulpho Tobacco Soap	189
Plane	141	Bean Poles	10	Grass Edgers	153, 157	Peat	176	Sulphur	189
Platycodon	130	Bellows	177	Grass Grower	191	Pea Trellises	29, 166	Sulphur Bowler	177
Plumbago	130	Berry Boxes	166	Grass Hooks	155	Pebbles	176	Sulphur Candles	189
Plums	145	Bill Hooks	162	Grass Shears	157	Persian Powder	188	Sun Dials	174
Polygonum	135	Bird Houses	187	Gravel Rakes	158	Phosphate	190, 191	Supports	166, 167
Poplar	141	Bird Seeds	187	Greenhouse White	170	Picks	161	Syringes	179
Poppies	128	"Black Leaf (40)"	188	Grindstones	147	Plant Food	191	Tankage	191
Primula	130	Blood (Dried)	190	Hammers	161	Plant Labels	113, 176	Tennis Court Markers	150
Privet	136	Blood Flour	190	Handles	159	Plant Life	191	Thermometers	26, 170
Pueraria	135	Bon Arbor	190	Hangin Baskets	173	Plant Spray	189	Thermostats	170
Pyrethrum	130	Bone (Coarse Ground)	190	Harrowes	146	Plant Stakes	175	Thompson's Manure	191
Pyrus	138	Bone Meal	190	Hatchets	161	Plant Stands	173	Thrip Juice	189
Quinces	145	Bone Flour	190	Hay and Feed Cutter	165	Planet Jr. Tools	148, 149	Tinfoil	176
Quince, Japan	138	Books	192	Heaters	173	Plant Tubs	172, 186	Tobacco Dust	189
Ranunculus	130	Bordeaux Arsenate	188	Hedge Knives	162	Plant Supports	166, 167	Tobacco Soap	189
Raspberries	143, 144	Bordeaux Mixture	188	Hedge Shears	162	Plow Line Cotton	161	Tobacco Stems	189, 191
Retinospora (Cypress)	140	Border Shears	157	Hedge Trimmers	162, 163	Pliers	161	Tomato Support	166
Rhubarb	33, 37	Boro Wax	188	Hellebore	188	Plows	146, 148, 149	Toothpicks	176
Rhus	138	Brackets	173	Hoes	159, 160	Poles	175, 177	Torches	177
Rosemary	37	Brooders	182, 183	Hog Manure	191	Porch Boxes	172	Trap Nest Front	181
Rose of Sharon	137	Broom Rake	153, 158	Horn Shavings	191	Post Hole Diggers	161	Traps	157, 164
Roses	110 to 115	Brooms	157	Horse Boots	150	Potato Knife	31	Tree Bands	189
Rudbeckia	130	Brushes	157	Hose	168	Potato Fertilizer	191	Tree Brushes	191
Sage	37	Brush or Briar Hooks	162	Hose Bands	168	Potato Scab Destroyer	31	Tree Guards	167
Salisburya	141	Buck Saw	164	Hose Connections	168	Potato Shovel	159	Tree Labels	167
Salvia	109, 130	Bug Death	188	Hose Couplings	168	Pots	186	Tree Paint	176
Saponaria	130	Bulb Fibre	176	Hose Menders	168	Pot Brackets	173	Tree Pruners	163
Saxifraga	130	Bulb Pans	186	Hose Nozzles	169	Pot Hangers	173, 186	Tree Scrapers	161
Scabiosa	131	Bulldog Clips	176	Hose Reducers	168	Pot Labels	176	Tree Tanglefoot	189
Scarlet Sage	109, 130	Butter Churns	181	Hose Reels	168	Poudrette	191	Trellises	29, 166, 167
Sedum	131	Cane Stakes	175	Hose Washers	168	Poultry Manure	191	Trimmers	153, 162, 163
Senedio	131	Canning Apparatus	165	Hotbeds	174	Powder Supplies	180 to 185	Trowels	160, 161
Shade Trees	141	Carnation Bands	176	Hotbed Mats	174	Powder Guns	177	Tuhs	186
Shrubs	137 to 139	Carnation Clips	176	Hotbed Sash	174	Protecting Cloth	174	Turf Lifters	157
Snapdragon	108	Carnation Staples	176	Hovers	182, 183	Pruners	162, 163	Twine	8, 176
Snowball	139	Carnation Supports	167	Humogerm	42	Pruning Compound	176	Vaporizing Lamps	177, 185, 189
Snowberry	138	Celery Bleachers	164	Husking Pins	161	Pruning Gloves	178, 186	Vases	178, 186
Solidago	131	Celery Handlers	164	Humus	191	Pruning Shears	162	Wagon Heaters	173
Spiraea	131, 138	Celery Hillyer	149	Hyacinth Stakes	175	P. T. B.	189	Wall Nails	173
Spruce	140	Celery Paper	16	Hydrant Attachment	168	Pulverizers	148	Water Barrels	150
Statice	131	Celery Tape	16, 176	Hydrometers	188	Putty	170	Water Cans	169
Stocks	109	Cemetery Hooks	173	Implement Handles	159	Putty Distributors	170	Wax Paper	174
Stokesia	132	Charcoal	176	Incubators	181	Pyrox	189	Weeders	146, 157, 160
Strawberry Plants	144	Cherry Stoner	165	Inoculating Bacteria	42, 190	Raffia and Raffia Tape	8, 176	Weed Gun	177
Suacac	138	Chick Boxes	181	Insecticides	188, 189	Rakes	153, 158	Weed Killer	176
Summer Hyacinth	107	Chrysanthemum Manure	190	I X L Compound	188	Rat Corn	185, 189	Weed Puller	157
Sunflower	125	Churns	181	Kainit	191	Rat Traps	164	Wheel Fertilizer	191
Sweet Potato	31, 37	Cider Mills	165	Kaylox	188	Readeana Rose Bug Ext.	189	Wheelbarrows	150
Sweet Shrub	137	Clay's Fertilizer	190	Kegs	165	Reels	161, 166	Whecl Hoos	148, 149
Sweet William	131	Clensel	188	Kerosene Emulsion	188	Road Brushes	157	Wilson's O. K. Plant Spray	189
Symphoricarpus (Snowb'y)	138	Colony Houses	183	Knives	8, 31, 162	Road Scoops	147	Wind Mill	164
Syringa	139	Copper Solution	188	Labels	113, 176	Rollers	156	Window Boxes	172
Tamarix	138	Corn Knife	161	Ladders	164	Rolling Stands	186	Wire Presses	172
Tanacetum	132	Corn Planters	147	Lamps (Vaporizing)	177, 185, 189	Roofing Paper	174	Wire	175
Tarragon	23, 34, 37	Corn Poppers	19	Land Plaster	191	Root Cutters	165	Wire and Tin Shears	174
Taxus (Yews)	140	Corn Shellers	165	Lawn Cleaners	150	Rubber Aprons	169	Wire Work	167
Thalictrum	132	Cotton Seed Meal	190	Lawn Guards	173	Rubber Hose	168	Wire Baskets	173
Thermopsis	132	Coupling Parts	168	Lawn Mowers	151 to 155	Rubber Sprinklers	169	Wire Netting	166
Thuya (Arbor Vitae)	140	Cow Manure . 3rd cover	190	Lawn Mower Oil	155	Rubbish Baskets	157	Worm Killer	189
Thyme	34, 37	Crow Repellant	44	Lawn Mower Sharpener	152	Rubbish Consumers	164	Worm Eradicator	189
Tomato	35, 37	Cultivators	148, 149	Lawn Rakes	158	Rustic Bark	172	Wrenches	161
Tradescantia	132	Cultivator Teeth	148, 149	Cut Flower Boxes	174	Rustic Furniture	172	Zementine	176
Trees	141, 145	Cut Worm Destroyer	188			Salt	8, 191	Zenolium	189

MICHELL'S VEGETABLE SEED SPECIALTIES

In line with our usual custom, we have taken from our general list certain specially meritorious varieties of vegetable seeds, to which we call, on this and the 3 succeeding pages, special attention. Planters will do well to include these sorts in their seed order.

PEDIGREED WASHINGTON ASPARAGUS

This new high yielding pedigree rust resistant Asparagus is the result of 13 years of careful scientific breeding by the Bureau of Plant Industry.

The shoots are usually dark green with a rich purple tinge, with a clean straight growth and of the finest market type, with a tight pointed bud and not branching out until well beyond the market height.

The shoots are very large on the average and the high branching habit of this strain makes it possible to cut unbranched shoots with good tight buds as much as two feet long. The branches of the mature shoots after they grow up are much less spreading than those of ordinary asparagus. Other strains should not be mixed in with Washington Asparagus and sold as the new stock, neither should the grower lose the advantage to be gained by selling the new kind separately under its own name.

Strong 2 year old roots, ready after March 15th. 75c. per doz.; per 100, \$3.50; \$30.00 per 1000. If wanted by mail, add 5c. per doz. or 15c. per 100 for postage.

If Beans are wanted by Parcel Post, please add postage as per table on page 1.

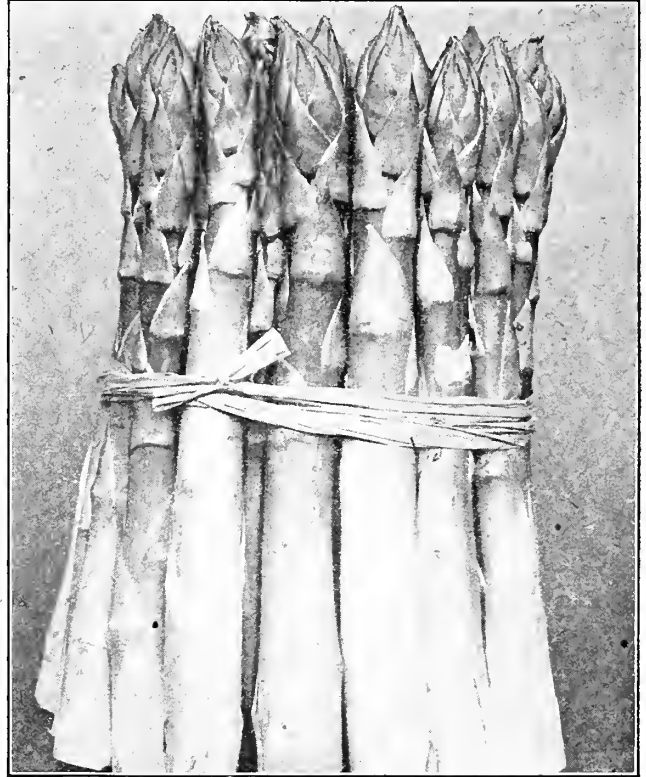

Washington Pedigreed Asparagus (Rust Proof)

BEAN

Dwarf Green Pod Masterpiece

This is a large flat podded variety especially suited for growing under glass, though it may be planted successfully out of doors; a very quick grower; plants robust and very prolific; the pods are long and very tender. Pkt., 15c.; 75c. per lb.; 2 lbs., \$1.40; \$3.00 for 5 lbs.; 10 lbs., \$5.50.

NEW BUSH LIMA BEAN WILSON'S IMPROVED

Claimed to be 2 weeks earlier than Burpee's Improved Bush Lima, surely a most important feature in any lima bean, because it is from the early maturing garden products, money, or at least the most of it, is made. It is also much more prolific than the Burpee's Improved, though the pod or the bean is not quite so large, the latter we believe to be rather an advantage. It is our belief that when this variety is properly known it will meet with general favor. Be sure and plant a supply of them if you want the latest in bush limas. Pkt., 10c.; 40c. per lb.; 2 lbs., 75c.; \$1.75 for 5 lbs.; 10 lbs., \$3.25; \$7.50 for 25 lbs.

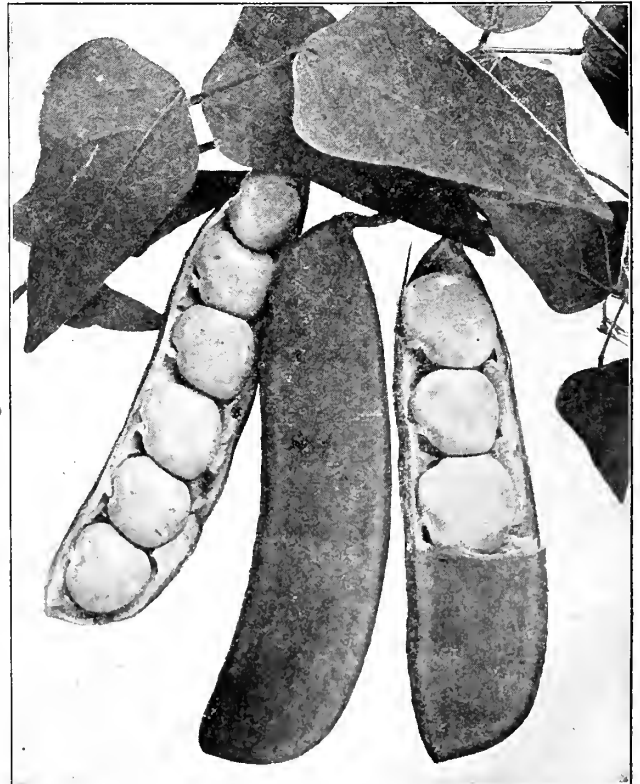

Bean, Wilson's Improved Bush Lima

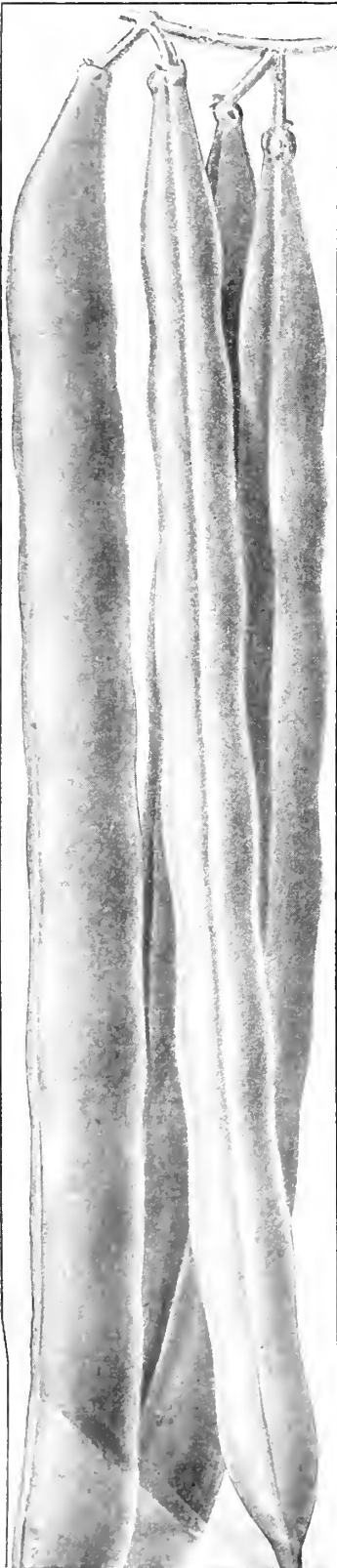

Bean, Masterpiece

MICHELL'S

Reliable
VEGETABLE SEEDS

ICICLE RADISH
IMPROVED
STRAIN



TOMATO
PONDEROSA

BEEF
MICHELL'S
WINTER KEEPER



DWARF BEAN
MASTERPIECE



Bean, Masterpiece
Pkt. 15c; 75c per lb; 2 lbs.
\$1.40; \$3.00 per 5 lbs;
10 lbs. \$5.50.

**Beet, Michell's
Winter Keeper**
Pkt. 10c; 20c per 1/2 oz;
oz. 35c; \$1.10 per 1/4 lb;
lb. \$3.50.

Radish, Icicle
Pkt. 10c; 15c per oz; 1/2
lb. 50c; \$1.50 per lb.

Tomato, Ponderosa
Pkt. 10c; 30c per 1/2 oz;
oz. 60c; \$2.00 per 1/4 lb.

One pkt. of each of above
for 40c

MICHELL'S VEGETABLE SEED SPECIALTIES



BEET

Michell's "Winter Keeper"

This grand new beet is almost globe shaped, tapering slightly toward the root. The dark blood red flesh is always tender. The hard, stringy, woodenlike substance, so common in many varieties, is entirely absent in this sort. It is ideal as a late summer cropper, or for use during winter and spring, until new beets are on the market again. See reverse side for color plate. Pkt., 10c.; 20c. per ½ oz.; oz., 35c.; \$1.10 per ¼ lb.; lb., \$3.50.



Celery, Easy Blanching (Penna. Grown Stock)

NEW SWEET CORN

"Sugar Kernel"

This variety originated with one of our customers in the Spring of 1919 and it was discovered by the gardener to be so entirely distinct from the balance of a planting that he marked it and tested it for sweetness and eating qualities and found it to be exceptional. One of its peculiar features is that it may be eaten free or entirely clear of the cob. Being pleased with this discovery the gardener made a test of it during 1920, planting it on April 20th together with Early Maine and Golden Bantam, the results were that the Early Maine matured on July 12th, the Golden Bantam July 15th and the Sugar Kernel on July 15th.

It is apparent that it is as early as the Golden Bantam yet especially desirable for late maturity and it is far superior in point of test than any other brand of Corn he had been growing.

The gardener who originated this variety and gives us this description states he has been growing Sugar Corn for twenty years and this is the best Corn he has ever had any experience with. The ears are cylindrical, medium size and often two ears on a stalk; he gave us this description on October 18, 1921, when he stated this variety was maturing in the garden and of exceptional quality.

Pkt., 10c; 60c. per lb.; 2 lbs., \$1.00; \$2.25 for 5 lbs.; 10 lbs., \$4.25; \$10.00 for 25 lbs.

BEET

Detroit Dark Red (Michell's Special Strain)

A selected strain grown for us by a very careful grower. An early, globe-shaped variety; good size, smooth and handsome and of a dark blood red color; the flesh is deep vermilion red, zoned with a lighter shade of the same color; of excellent quality, and a desirable sort for canning. Suitable for fall use as well as for spring. Pkt., 10c.; 25c. per oz.; ¼ lb., 70c.; \$2.25 per lb.

CELERY

Michell's Easy Blanching

(Private Stock, Penna.
Grown)

This variety, without exception, is probably the most important celery introduction in recent years. The stalks are broad, fine grained and crisp, with a big heart that blanches a beautiful white with yellow leaf tips. As a celery for autumn and Thanksgiving, we believe it has no equal. Pkt., 15c.; 85c. per ½ oz.; oz., \$1.50; \$5.00 per ¼ lb.

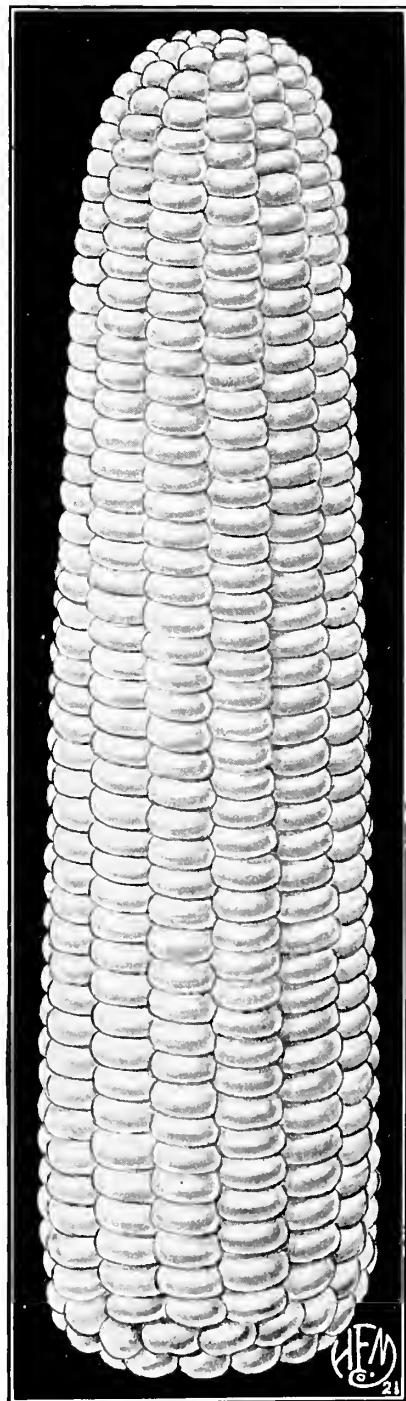

Corn, Sugar Kernel



New York or Wonderful Lettuce

LETTUCE, New York or Wonderful

This variety is also referred to as Los Angeles Lettuce, because it is shipped in such large quantities from that district to the Philadelphia and other Eastern markets; from one growing point and shipping station alone during one winter over 70 carloads were shipped to New York City. This is the lettuce that has for the past few years been in great demand, especially during the late winter and early spring months; its gigantic heads when the outer leaves are removed are almost white, very solid and as it grows in California apparently is without any trace of bitter taste. We have experimented with several varieties to determine definitely what this California variety was and found it to be as above offered. It does best in the latitude of Philadelphia as an early spring and a late autumn crop; while not quite as fine as it grows in California it is, nevertheless, lettuce which deserves greater recognition than it has heretofore received. Every market gardener should grow a quantity of it as it will find a ready sale, being already popularized by reason of its wide distribution during the past few years. We offer an unusually fine strain of seed, selected from specimen heads. 10c. per pkt.; 1/2 oz., 15c.; 30c. per oz.; 1/4 lb., \$1.00; \$3.25 per lb.

ONION, Michell's White Bermuda

Many people who garden like to sow onion seed that will produce a full-sized onion the first season. The White Bermuda variety combines this feature, in addition to being extremely large, mild-flavored and of wonderful uniformity. For boiling, eating raw on sandwiches, or as garnishing on green salads, it is unquestionably good. Seed should be sown in a bed thinly. When 3 or 4 inches high, transplant the seedlings in rows about 1 1/2 feet apart and about 4 or 5 inches apart in the row. A dull day is best for this, when the soil is moist, to insure the seedlings establishing themselves readily. Prior to planting the top should be nipped off, so that the plants will stand about 2 1/2 inches high. This variety, like all onions, delights in rich soil. They should be well cultivated during the growing period, and when the seed heads appear the plant should be bent over to develop the bulb. Pkt., 10c.; 25c. per 1/2 oz.; oz., 45c.; \$1.50 per 1/4 lb.; lb., \$5.00.

PEAS, EXTRA EARLY EIGHT WEEKS

This is one of the earliest dwarf Peas in cultivation. They usually grow to a height of from 12 to 15 inches; on account of their dwarf habit they can be planted closer than most other varieties, yielding a greater quantity of peas from a comparatively small space of ground than from almost any other variety. The pods are of medium size and well filled with peas of extra fine quality. Pkt., 10c.; 35c. per lb.; 2 lbs., 65c.; \$1.60 for 5 lbs.; 10 lbs., \$3.00; \$7.00 for 25 lbs.

Testimonial

We gave your "Delicious" Muskmelon a trial last year and were quite successful with it. Some of the fruits weighed 12 lbs. each.

Richboro, Pa.

BENSON BROS.

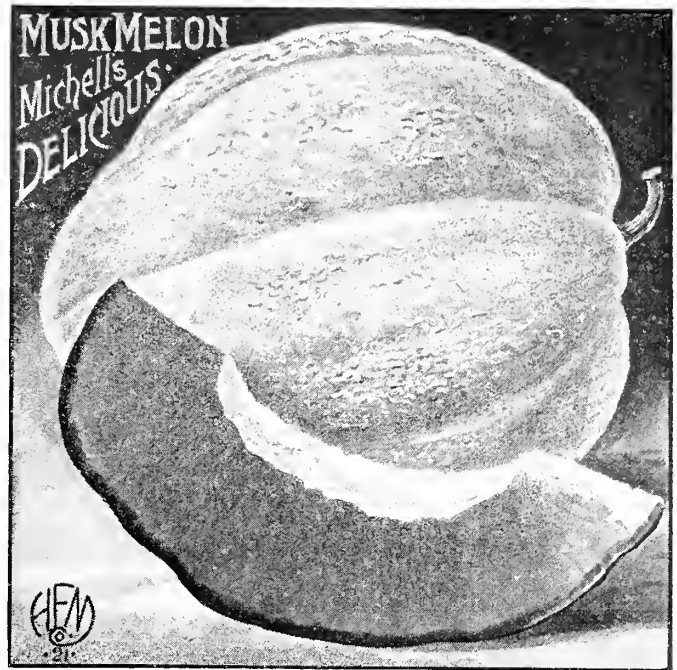

MUSK MELON, Michell's Delicious

This variety deservedly enjoys a good name; it is one of the very large irregular pumpkin-shaped melons with a smooth silver gray rind. The flesh is very deep orange salmon and represents most of the melon, as the seed space is very small with but few seeds. One melon of this variety is frequently enough for a family of three or four. 20c. per pkt.; 1/2 oz., 60c.; \$1.00 per oz.; 1/4 lb., \$3.00.

Prices on all Vegetable Seeds, except Peas, Beans and Corn, include postage charges. For mailing charges on these see table on page 1.

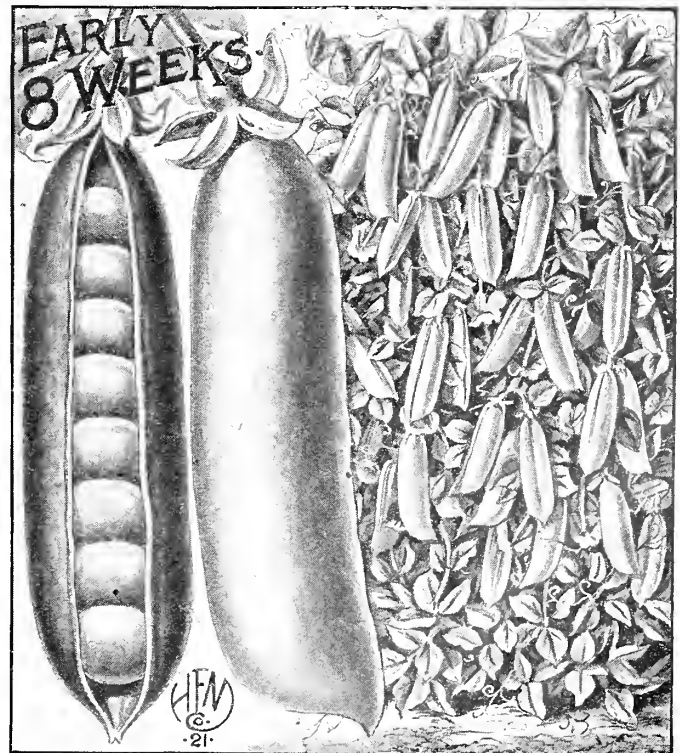

MICHELL'S PURE "SPORE" CULTURE MUSHROOM SPAWN IN CARTON FORM

The growing of Mushrooms is rapidly increasing, and the demand for them has reached immense proportions. A fine crop of mushrooms can be secured with very little labor or expense, provided a suitable location can be obtained. Cellars, greenhouses and sheds can be used for their culture.

SOMETHING NEW IN MUSHROOM SPAWN

We are now prepared to offer our customers spawn that is made in quart milk jars under absolutely sterile conditions. The bottle and materials are sterilized under steam pressure of twelve lbs. so that every mould, weed seed or insect is destroyed and each bottle contains nothing but the pure spawn. Every particle is full run, covered with spawn grown direct from the spores. One carton of the spawn equals 5 bricks of ordinary spawn and is sufficient to spawn about 40 square feet. It is less expensive than brick spawn and assures the amateur absolute success, always giving a crop if the beds are made properly. The sterile spawn is dried thoroughly and each piece wrapped in tissue paper, which contains full instructions, not only as to how the spawn should be used, but full particulars about growing mushrooms. Any one can order spawn and with it get the necessary knowledge to make growing entirely successful.



Photograph of Mushrooms growing from Sterilized Bottle Spore Spawn

PRICES

Per carton.....	\$ 1.00	25 cartons.....	\$22.50
12 cartons.....	10.75	60 cartons.....	48.00

See page 26 for Mushroom Spawn in brick form.



1. How the spawn is made and prepared for sterilizing.

2. The product finished, ready for packing in cartons.

3. The wrapped spawn, in round cartons where it will remain fresh almost indefinitely.

SEE PAGE 30 FOR GENERAL LIST OF PEPPERS

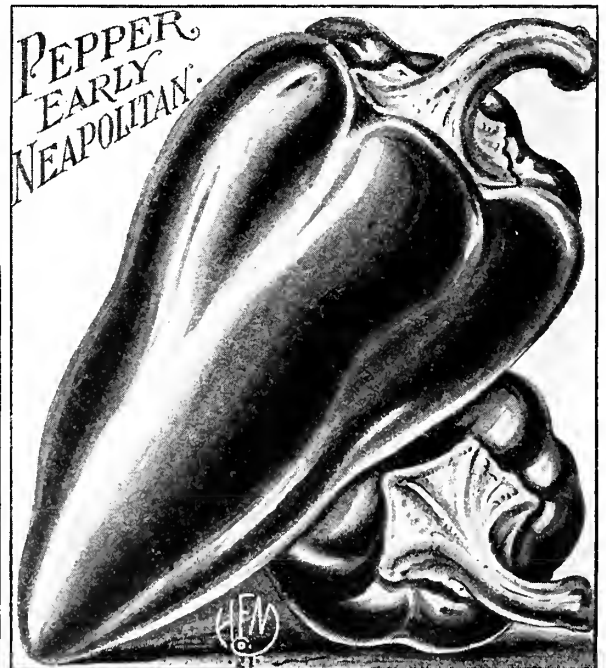

PEPPER, EARLY NEAPOLITAN

The earliest and sweetest of all large fruited varieties. The strong vigorous plants are completely laden with long handsome fruits and bear continuously until frost. The peppers grow upright until they become so heavy that their own weight turns them down. The skin and flesh are bright red when ripe; thick meated, sweet and mild. Pkt., 10c.; ½ oz., 20c.; 35c. per oz.; ¼ lb., \$1.20 (postpaid).

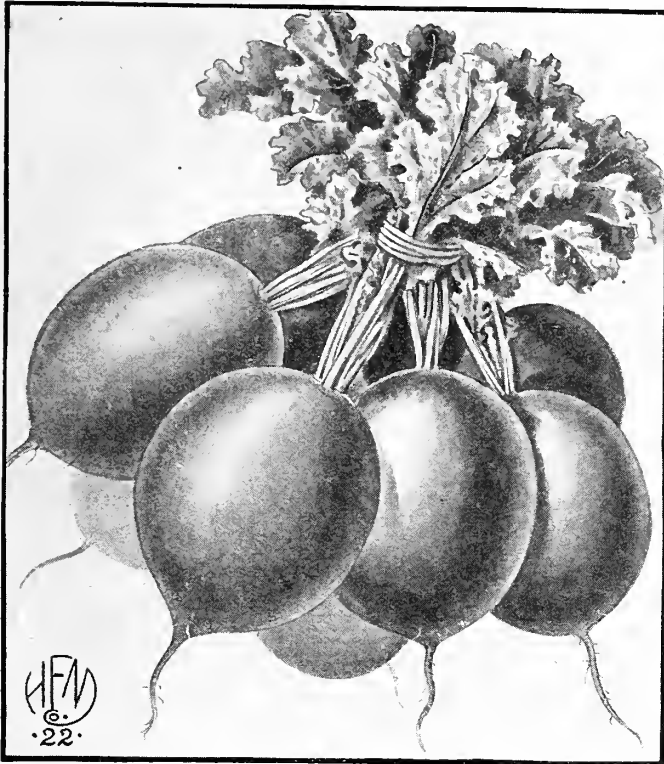

Radish, Scarlet Globe (Special Forcing)

RADISH, Early Scarlet Globe (Special Forcing)

This is the most popular variety on the market, for hot-bed or greenhouse forcing; also valuable for out-door planting. Very early, crisp, mild and tender; very attractive. Color, rich, bright scarlet; of uniform globe shape; stands heat without becoming pithy; matures in 25 days; top is small. Pkt., 10c.; 25c. per oz.; ¼ lb., 65c.; \$2.25 per lb.

Testimonial

Your early Red Wonder Tomato is beyond all praise; from about 28 plants reserved for ourselves we gathered literally bushels of beautiful and perfect fruits. Mrs. W. F. G.



Spinach, Market Gardeners

NEW SPINACH MARKET GARDENERS

This new variety is the highest perfection of the Spinach family, being a decided improvement on all other kinds. The leaves are broad, heavy and of a dark green, glossy color, very heavily blistered compared to Long Season; it will also stand at least a week or ten days longer without shooting to seed, which is an important factor. The plant is not of the rosette type, standing more erect, and requiring a less number of plants to fill a basket than any other variety. A trial will convince you of the tenderness and superior quality of this variety. Per oz., 10c.; 30c. per ¼ lb.; lb., \$1.00; \$4.50 per 5 lbs.

TOMATO, EARLY RED WONDER

This variety is the result of a cross between "My Maryland" and "Magnificent," having originated with Mr. W. E. Vail, of Yorktown Heights, Westchester Co., N. Y. He has been watching it for a number of years, and finally thinking so well of it he asked us if we would not place it on the market, with the right to name it, which we have done, and we believe the name does it justice. The fruits are fairly large, extremely solid and of a beautiful "tomato red" color. It is a shy seeder, therefore very solid. It is a wonderful market variety, being uniform in shape and in fact it possesses about every good attribute that a tomato can have. It is medium early (not extra early) but a winner and we know you will like it. It is a tomato we believe can be successfully grown anywhere that tomatoes will grow. Since we have offered this new variety to our customers we have received numerous testimonials of the good results obtained from this variety. Pkt., 10c.; 30c. per ½ oz.; per oz., 50c.; \$1.75 per ¼ lb.

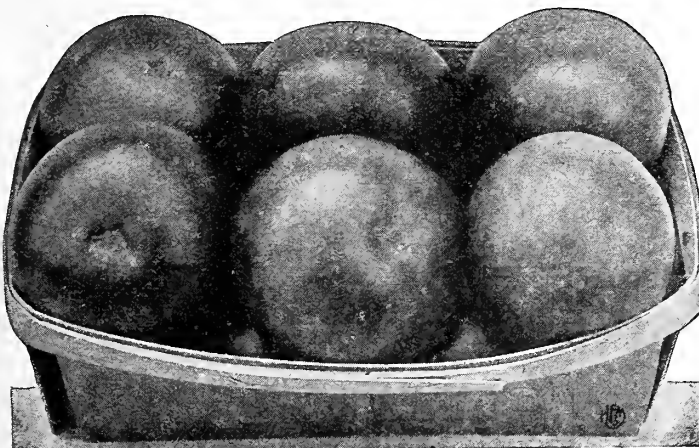

Tomato, Michell's Early Red Wonder

All seeds on this page mailed postpaid at quoted prices.

MICHELL'S DISTINCTIVE VEGETABLE SEEDS

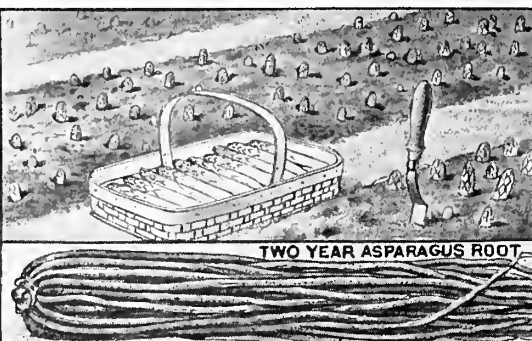
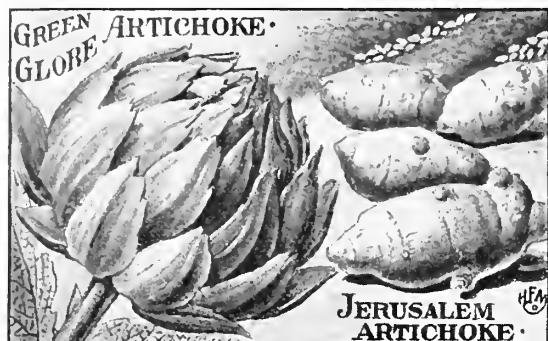

ANISE

Seed is used for flavoring. Pkt., 10c.; 20c. per oz.; $\frac{1}{4}$ lb., 75c.

ARTICHOKE

Artichaut (Fr.); Artishoke (Ger.); Articiocca (Ital). 1 oz. will produce about 500 plants.

Sow seeds in January in the greenhouse, or in hotbeds in March. Transplant when large enough, in rows 3 feet apart, 2 feet apart in the row. Cultivate when growing, freely, and protect the plants in winter by taking them in a cellar or putting in a cold frame; may be left outdoors protected by straw in a climate that is not too severe.

Green Globe. Pkt., 10c.; 35c. per $\frac{1}{2}$ oz.; oz., 60c.; \$2.25 per $\frac{1}{4}$ lb.

ARTICHOKE PLANTS

(Ready in April)

Green Globe. We grow a large stock of these, for those who do not care to bother with them from seed; thus they can be assured of an early crop. Pot grown. \$1.50 per doz.; 25 for \$3.00; \$10.00 per 100 (by express only).

ARTICHOKE ROOTS

Jerusalem (Ready in April)

Sometimes called the American Artichoke. Used for table and stock feeding. Cut the tubers to single eyes and plant them like potatoes, 3 to 4 feet apart each way, placing three or four tubers in a hill. Leave the tubers in the ground and dig them as wanted; they are hardy. 30c. per qt.; peck, \$1.50; \$5.00 per bu. of 60 pounds.

ASPARAGUS

Asperge (Fr.); Spargel (Ger.); Sparagio (Ital). Sow 5 lbs. per acre for roots, or 1 oz. to 100 feet.

A well-cared-for bed improves with age and lasts for many years. It may be established from seed, but much time is saved by planting roots. Seeds should be sown thinly in early spring in rows 1 foot apart. Thin out the weakest plants so the remainder will be 4 inches apart. When 1 year old transplant in the permanent bed in rows 3 ft. apart, setting the roots 1 ft. to $1\frac{1}{2}$ ft. apart, from where it can be cut three years later. "Michell's Practical Garden Pointers" gives full information and is mailed free.

Michell's Giant Argenteuil (Special Strain). A marketable shoot or spear is often two inches in diameter and 12 inches long, of which every part when boiled is tender and delicious. It is the one variety that succeeds well in all soils and climates. Color, white, with a greenish purple tip. Pkt., 10c.; 15c. per oz.; $\frac{1}{4}$ lb., 40c.; \$1.10 per lb.

Barr's Mammoth. Produces heavy, stout spears, of delicious flavor. Remains green when cooked. Pkt., 10c.; 15c. per oz.; $\frac{1}{4}$ lb., 40c.; \$1.10 per lb.

Conover's Colossal. A prolific sort, similar to Barr's Mammoth, but the stalks are a trifle larger and lighter in color. Pkt., 10c.; 15c. per oz.; $\frac{1}{4}$ lb., 40c.; \$1.10 per lb.

Palmetto or Eclipse. One of the earliest; very prolific and finely flavored. Color, green. Pkt., 10c.; 15c. per oz.; $\frac{1}{4}$ lb., 40c.; \$1.10 per lb.

ASPARAGUS ROOTS

(Ready after March 1st)

4000 to 6000 roots are required for an acre

	2-Year-Old Roots.		
	Doz.	100	1000
Barr's Mammoth	\$0.35	\$1.75	\$12.50
Conover's Colossal35	1.75	12.50
Giant Argenteuil35	1.75	12.50
Palmetto or Eclipse35	1.75	12.50
Washington (New)75	3.50	30.00
(Rust proof)	3-Year-Old Roots.		
	Doz.	100	1000
Barr's Mammoth	\$0.45	\$2.25	\$17.50
Conover's Colossal45	2.25	17.50
Giant Argenteuil45	2.25	17.50
Palmetto or Eclipse45	2.25	17.50

ACCESSORIES TO ASPARAGUS GROWING

Raffia Tape. A linen and paper composition in 250-yard spools; Nile green color. 90c. per bolt.

Asparagus Tape. Fast cherry red color, water-proof; in 1000-yard spools. Per spool, \$4.50.

Raffia. Ideal for tying asparagus in bunches. Natural, 25c. per lb.; 5 lbs. for \$1.10. Green, \$1.00 per lb.; 5 lbs., \$4.75.

Jute Twine. For tying asparagus, 2 and 3-ply; soft and pliable. Per ball, 20c.; 35c. per lb.

Asparagus Salt. Applied in the spring for destroying weeds, 600 to 800 lbs. per acre. \$2.00 per 100 lbs.; 200 lbs., \$3.25; \$13.00 per 1000 lbs.; ton, \$25.00.

Asparagus Fertilizer. Compounded after a formula recommended by a leading asparagus grower; apply 800 lbs. per acre. In 200-lb. bags, \$5.00; \$24.00 per 1000 lbs.; ton, \$42.50.

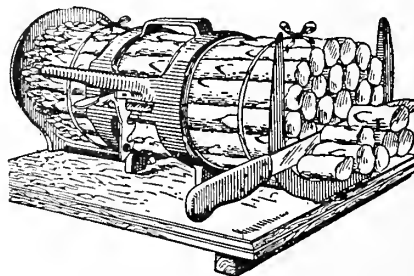

ASPARAGUS BUNCHER

It pays to use a buncher. Asparagus is quickly tied and looks uniform. With Knife Guard, \$3.75.

ASPARAGUS KNIVES

Fig. 110, No. 1. Asparagus Knife.....	\$0.65
Fig. 110, No. 3. Asparagus Knife, American. V-shaped blade; short handle.....	.65
Fig. 110, No. 3L. Asparagus Knife, American. V-shaped blade; long handle..	.65

A Book, entitled **Asparagus Culture**, by Hexamer, will solve any of the problems that may arise in growing the crop. Price, 90c.



Haricots Nains (Fr.); Buschbohnen (Ger.); Fagioli Nani (Ital.) Plant 90 lbs. per acre. 2 lbs. will plant a 100-foot row.

Cultural Directions.—A rich, sandy loam suits beans to perfection. Toward the end of April or, still better, in May, sowings may be made and may be repeated every two weeks until September. Have the rows about two feet apart. Sow quite thinly in the row and about two inches deep; thin out to stand four to six inches apart in the rows.

If beans are desired by mail, please add postage, as per table on page 1.



Improved Strain Golden Wax

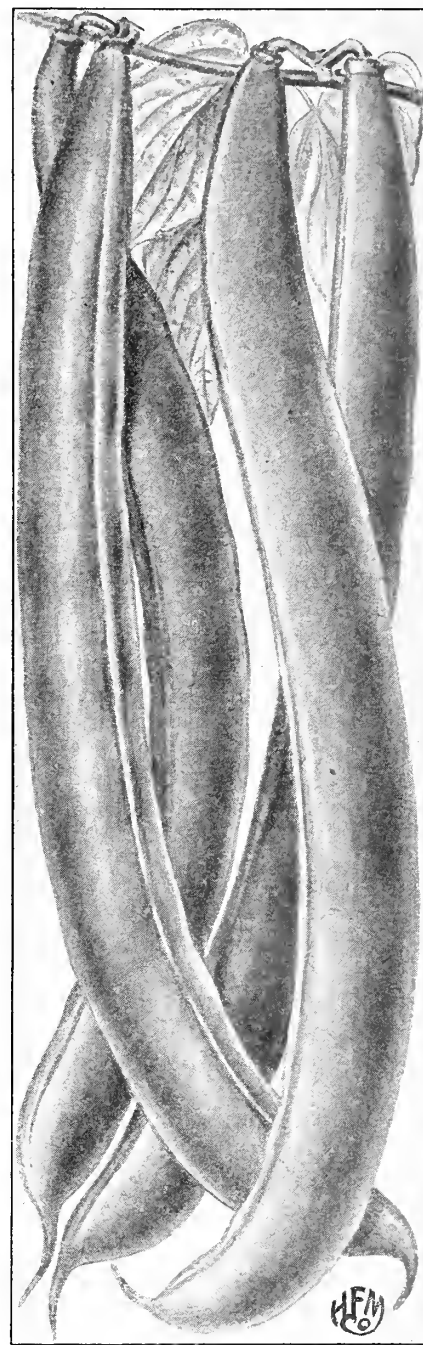

Black Valentine

GREEN PODDED VARIETIES

Black Valentine. Pods very long and slender, semi-round and well-flavored; slight string when old. Pkt., 10c.; 35c. per lb.; 2 lbs., 60c.; \$1.40 per 5 lbs.; 10 lbs., \$2.75; \$6.75 per 25 lbs.

Bountiful. A fine early flat-podded sort; stringless, tender and a prolific bearer. Pkt., 10c.; 35c. per lb.; 2 lbs., 60c.; \$1.40 per 5 lbs.; 10 lbs., \$2.75; \$6.75 per 25 lbs.

Early Mohawk. This variety can be planted before any other sort, being quite hardy; large cropper; flat pod. Pkt., 10c.; 35c. per lb.; 2 lbs., 60c.; \$1.40 per 5 lbs.; 10 lbs., \$2.75; \$6.75 per 25 lbs.

Extra Early Refugee. An extremely early, fleshy, saddleback pod variety; slight string as it ages. Pkt., 10c.; 35c. per lb.; 2 lbs., 60c.; \$1.40 per 5 lbs.; 10 lbs., \$2.75; \$6.75 per 25 lbs.

Full Measure. A prolific stringless variety of excellent quality and great merit. Pkt., 10c.; 35c. per lb.; 2 lbs., 60c.; \$1.40 per 5 lbs.; 10 lbs., \$2.75; \$6.75 per 25 lbs.

Mammoth Stringless. An improvement on Burpee's Green Pod; early round pod, free from string and, while not so prolific, makes a much larger pod. Pkt., 10c.; 35c. per lb.; 2 lbs., 60c.; \$1.40 per 5 lbs.; 10 lbs., \$2.75; \$6.75 per 25 lbs.

Masterpiece. This is a large, flat-podded variety, especially adapted for growing under glass, though it may be grown successfully outdoors; a very quick grower; very prolific; pods long and very tender. Pkt., 15c.; 75c. per lb.; 2 lbs., \$1.40; \$3.00 for 5 lbs.; 10 lbs., \$5.50.

Red Valentine (Michell's Improved). A carefully selected stock of this well-known variety; its popularity is due to the fact that it is one of the earliest sorts, maturing often in 45 to 50 days. Pkt., 10c.; 30c. per lb.; 2 lbs., 55c.; \$1.30 per 5 lbs.; 10 lbs., \$2.50; \$6.00 per 25 lbs.

Stringless Forcer. For culture under glass or for outdoor planting; the pods are long, slender, and round in shape; it grows dwarf and compact, and is a heavy yielder. Pkt., 10c.; 30c. per lb.; 2 lbs., 55c.; \$1.30 per 5 lbs.; 10 lbs., \$2.50; \$6.00 per 25 lbs.

***Stringless Green Pod (Michell's Improved Strain).** Even when the pod has become quite old it still retains its stringless qualities. It recommends itself also by its extreme earliness, prolific and continuous bearing qualities and superior flavor. Can be planted successively through the season; round pods often seven inches long. The leading sort for the home or market garden. Pkt., 10c.; 20c. per ½ lb.; lb., 35c.; 60c. per 2 lbs.; 5 lbs., \$1.40; \$2.75 per 10 lbs.; 25 lbs., \$6.75.

Triumph of the Frames. Splendid for forcing under glass, producing a long, narrow, tender pod. Pkt., 15c.; 60c. per lb.; 2 lbs., \$1.10; \$2.50 per 5 lbs.

WAX OR YELLOW-PODDED VARIETIES

These should not be planted quite as early as the green varieties, they being more tender and liable to rot.

Black Wax (Pencil Pod Strain). A round-podded, hardy sort, entirely stringless, very early. Pkt., 10c.; 35c. per lb.; 2 lbs., 60c.; \$1.40 per 5 lbs.; 10 lbs., \$2.75; \$6.75 per 25 lbs.

Currie's Rust-proof Wax. An improved type; extra early; a tremendous yielder; long, thick, flat pods. Pkt., 10c.; 35c. per lb.; 2 lbs., 60c.; \$1.40 per 5 lbs.; 10 lbs., \$2.75; \$6.75 per 25 lbs.

***Golden Wax Rust Proof (Michell's Improved Strain).** This type far surpasses the old favorite in many points; the plants are very vigorous and rust-resisting. The thick, flat, stringless pods are formed quite early and in great profusion. Pkt., 10c.; 20c. per ½ lb.; lb., 35c.; 60c. per 2 lbs.; \$1.40 per 5 lbs.; 10 lbs., \$2.75; \$6.75 per 25 lbs.

Refugee Wax. Round-podded, entirely stringless and of exceptional flavor. Pkt., 10c.; 35c. per lb.; 2 lbs., 60c.; \$1.40 per 5 lbs.; 10 lbs., \$2.75; \$6.75 per 25 lbs.

Round-Podded Kidney Wax. A vigorous grower, producing very fleshy pods, entirely stringless and rust-proof; very early. Pkt., 10c.; 35c. per lb.; 2 lbs., 60c.; \$1.40 per 5 lbs.; 10 lbs., \$2.75; \$6.75 per 25 lbs.

Sure Crop Stringless Wax. Very early and productive and very hardy, resisting rust and disease with impunity; pods long, thick and flat; a splendid variety. Pkt., 10c.; 35c. per lb.; 2 lbs., 60c.; \$1.40 per 5 lbs.; 10 lbs., \$2.75; \$6.75 per 25 lbs.

Wardwell's Kidney Wax. A favorite market bean; long, thick, flat pods in great abundance; one of the best medium early sorts; excellent quality; free from rust. Pkt., 10c.; 35c. per lb.; 2 lbs., 60c.; \$1.40 per 5 lbs.; 10 lbs., \$2.75; \$6.75 per 25 lbs.

MICHELL'S POLE BEANS (Not Limas)

Haricots a Rames (Fr.); Stangenbohnen (Ger.); Fagioli (Ital.).



Golden Cluster Wax

Plant when all danger of frost or cold nights is over. Don't be afraid to put a liberal number in a hill, as this is cheaper than replanting.

Plant as you would limas, in hills 4 feet apart each way, about 4 or 5 beans to the hill, eyes downward. When up and established, thin out to 3 plants in a hill. Plant about 20 lbs. to the acre.

Pole Beans are not accorded in the north the same attention they deserve and receive in the southern part of the United States, where they are found in practically every garden. They are frequently more tender, and yield larger crops than dwarf sorts. One planting lasts usually for the season. The secret of success in growing them is to keep picking them as they mature; they then continue to bear and yield quantities of tender beans of delicious flavor. If you've never grown them before try them this season.

POSTAGE NOTICE.—If Pole Beans are desired by mail, please add postage, as per parcel post table on page 1.

***Early Golden Cluster Wax.** A beautiful deep yellow pod, flat and frequently 8 inches long; makes a delicious dish as a butter bean or for pickling; quite stringless and matures in about 85 days. It is a heavy yielder, the pods being borne in large clusters. The best of the pole beans and a splendid variety for the home garden. Pkt., 10c.; 25c. per $\frac{1}{2}$ lb.; lb., 40c.; 75c. per 2 lbs.; 5 lbs., \$1.75; \$3.00 for 10 lbs.; 25 lbs., \$6.75.

Scarlet Runner (Green Pod). While used principally for its flowering qualities, this makes a splendid winter shell bean. The bright red flowers are an attraction when the vine is used for covering arbors, trellis, fences, posts, etc. Pkt., 10c.; 35c. per lb.; 2 lbs., 65c.; \$1.50 per 5 lbs.

***Kentucky Wonder (Old Homestead).** Green Pod. In the South this variety is grown more extensively probably than any other; a tremendous yielder of long, round pods, very tender and practically stringless; the best of the green pole beans. It is quite early, being ready for picking about 85 days from planting. Pkt., 10c.; 20c. per $\frac{1}{2}$ lb.; lb., 35c.; 65c. for 2 lbs.; 5 lbs., \$1.50; \$2.75 for 10 lbs.; 25 lbs., \$6.00.

DWARF VARIETIES OF SHELL BEANS—For Winter Use

If there is any vacant space in the garden it always pays to plant some of these varieties. For soups, baked beans, etc., they are always useful. They can be used in the green state like other sorts when picked very young, but for the first-named purpose they are the best.

Boston Navy or Pea. For soup and baking purposes. 10c. per pkt.; per lb., 30c.; 55c. for 2 lbs.; 5 lbs., \$1.25; \$2.40 per 10 lbs.; 25 lbs., \$5.75.

Broad Windsor. An English bean used in the dry state shelled. Plant in rows about 3 feet apart, about 8 inches apart in the row. Pkt., 10c.; 35c. per lb.; 2 lbs., 60c.; \$1.40 per 5 lbs.; 10 lbs., \$2.75; \$6.75 per 25 lbs.

White Marrowfat. Pkt., 10c.; 30c. per lb.; 2 lbs., 55c.; \$1.25 per 5 lbs.; 10 lbs., \$2.40; \$5.75 for 25 lbs.

Dwarf Horticultural. One of the best early shell beans grown; the thick, flat, stringless pods are colored red and green; the bean is large, round and speckled. Pkt., 10c.; 35c. per lb.; 2 lbs., 60c.; \$1.45 per 5 lbs.; 10 lbs., \$2.75; \$6.75 per 25 lbs.

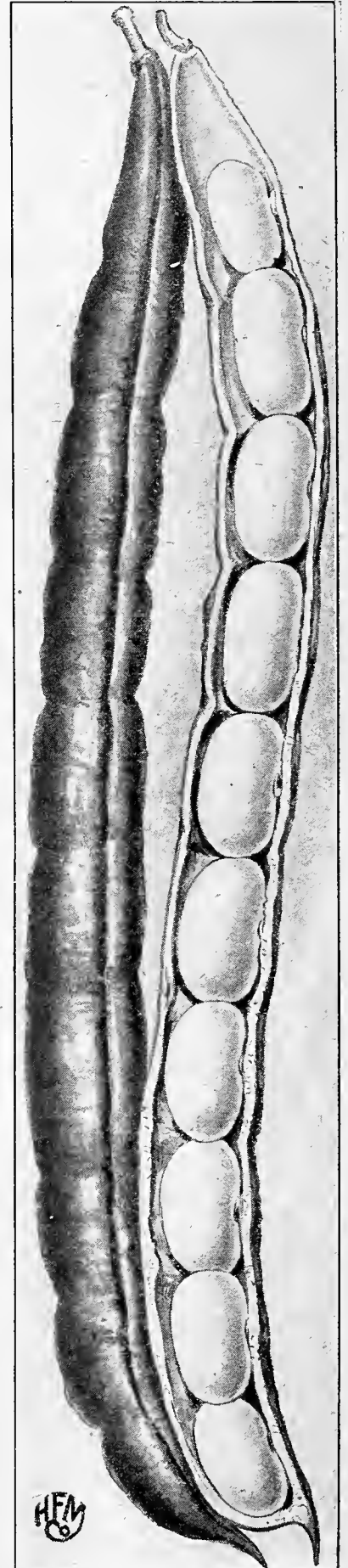

Kentucky Wonder Bean

PLEASE NOTE.—Only varieties of Beans marked * can be supplied in $\frac{1}{2}$ -lb. pkgs.

CEDAR BEAN POLES (Pointed). Extra selected quality, about 10 feet long. 12 for \$2.25; 25 for \$4.00; 50 for \$7.75; \$15.00 per 100.

NITROGEN BACTERIA FOR BEANS

If you want your lima bean patch to yield earlier and better, inoculate the seed before planting with nitrogen bacteria. We offer the following Brands: **Mulford Germ**, trial size, 35c.; 75c. per $\frac{1}{4}$ acre size; 1 acre size, \$1.50. **Standard Bacteria**, trial size, 25c.; garden size, 50c.; 75c. per acre bottle. **Farmogerm**, $\frac{1}{4}$ acre size, 50c.; \$1.00 per acre size. See page 42.

When ordering, be sure and specify wanted for garden beans, as each leguminous crop requires a separate culture.

MICHELL'S LIMA BEANS

Haricots a rames (Fr.); Stangenbohnen (Ger.); Fagioli di Lima (Ital.)

POLE VARIETIES

2 pounds will plant 100 hills; 25 to 30 pounds per acre.

Plant when all danger of frost or cold nights is over with the eye of the bean down. Don't be afraid to put a liberal number in a hill, as this is cheaper than replanting. When up and established, thin out to 3 or 4 plants in a hill. The poles should be set as soon as the garden is made in rows about 3 feet apart, with the poles about 3 feet apart in the row. It is a good plan to put a small shovelful of well-rotted cow manure in each hill when the poles are set, so the beans when started will make rapid growth and mature early.

POSTAGE NOTE.—If beans are wanted by mail, please add postage, as per parcel-post table on page 1.

Carpinteria. A variety that retains its green color in all stages of growth, even after being dried; with this it combines wonderful prolificness, flavor and size; a good early variety; 4 to 5 beans in a pod. Pkt., 10c.; 40c. per lb.; 2 lbs., 70c.; \$1.60 per 5 lbs.; 10 lbs., \$3.00; \$6.75 per 25 lbs.

Dreer's Improved Potato or Challenger. Early and more prolific than the Large Lima; beans small; extra quality. Pkt., 10c.; 35c. per lb.; 2 lbs., 65c.; \$1.50 per 5 lbs.; 10 lbs., \$2.75; \$6.50 per 25 lbs.

Giant Podded. This variety is fully a week earlier than King of the Garden. It is a prodigious cropper, producing its pods in large clusters; these are well filled with large beans of excellent quality. Pkt., 10c.; 35c. per lb.; 2 lbs., 65c.; \$1.50 per 5 lbs.; 10 lbs., \$2.85; \$6.50 per 25 lbs.

***King of the Garden.** Pods are of enormous size, many specimens measuring from 5 to 8 inches and producing as high as six beans to the pod, perfectly formed and of superior quality. Pkt., 10c.; 20c. per ½ lb.; lb., 35c.; 65c. per 2 lbs.; 5 lbs., \$1.60; \$3.00 per 10 lbs.; 25 lbs., \$6.50.

Michell's Evergreen. A variety which had its origin in Philadelphia. This remarkable pole lima equals the earliest for earliness, is far more productive than any other, and retains at all times a beautiful green color. Pods contain on the average 5 to 6 beans. Pkt., 10c.; 35c. per lb.; 2 lbs., 65c.; \$1.60 per 5 lbs.; 10 lbs., \$3.00; \$6.75 per 25 lbs.

BUSH OR DWARF VARIETIES

Bush Limas should be planted for early crops, as they come into bearing much sooner, although they are not so prolific as the pole varieties. They are usually planted in rows about 3 feet apart, while the beans are put in hills about 2 feet apart, about 3 beans to the hill.

Burpee's Improved Bush Lima. This is so far ahead of the old strain of Burpee's Bush Lima that it should be used instead; the bean is thicker, sweeter, and more prolific. Pkt., 10c.; 40c. per lb.; 2 lbs., 70c.; \$1.65 per 5 lbs.; 10 lbs., \$3.15; \$7.00 per 25 lbs.

***Fordhook.** This is the best type of bush lima in cultivation; it has a distinct upright vigorous growth; the pods are borne in clusters well above the ground and frequently contain as many as 4 thick luscious beans. It

matures very early and continues in bearing till frost. Pkt., 10c.; 25c. per ½ lb.; lb., 40c.; 75c. per 2 lbs.; 5 lbs., \$1.60; \$3.00 per 10 lbs.; 25 lbs., \$6.50.

Hendersons. A dwarf, compact growing variety, with large clusters of pods, containing very small flat beans; this is a favorite sort for canning. Pkt., 10c.; 35c. per lb.; 2 lbs., 65c.; \$1.60 per 5 lbs.; 10 lbs., \$2.75; \$6.50 for 25 lbs.

Wilson's Improved (New). Claimed to be two weeks earlier than Burpee's Improved Bush Lima; it also is much more prolific, though the pod nor the bean is quite as large. For full description and illustration, see page 4. Pkt., 10c.; 40c. per lb.; 2 lbs., 75c.; \$1.75 per 5 lbs.; 10 lbs., \$3.25; \$7.50 per 25 lbs.

NITROGEN BACTERIA FOR BEANS

If you want your lima bean patch to yield earlier and better, inoculate the seed before planting with nitrogen bacteria. We offer four Brands. See page 42.

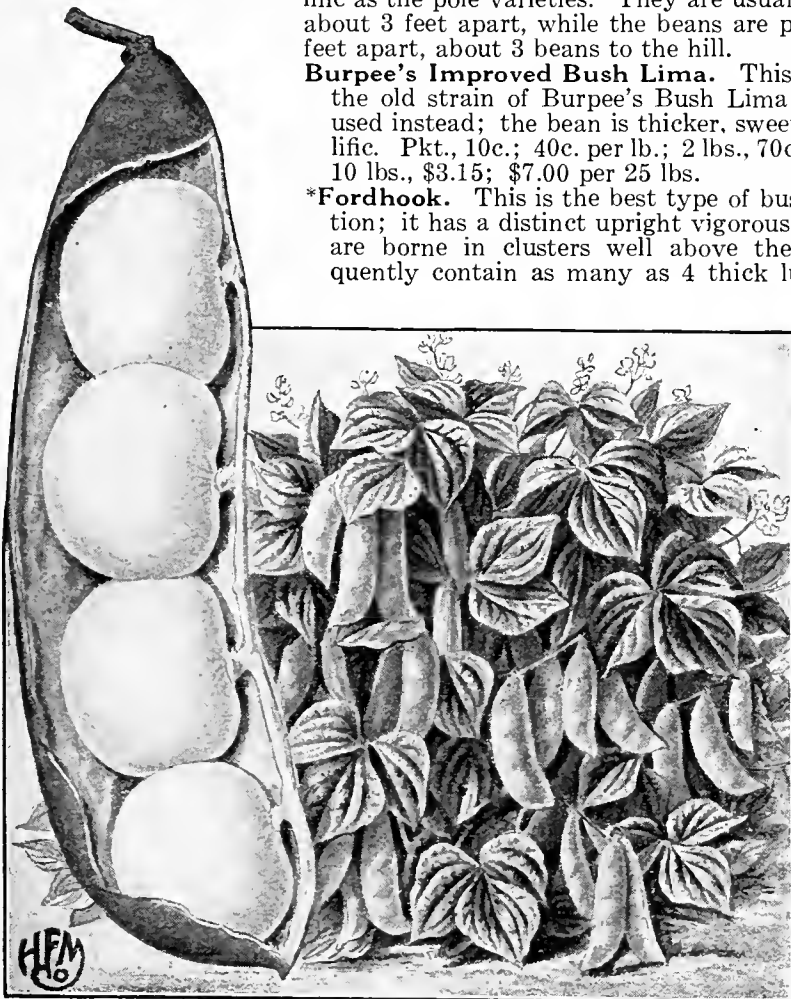
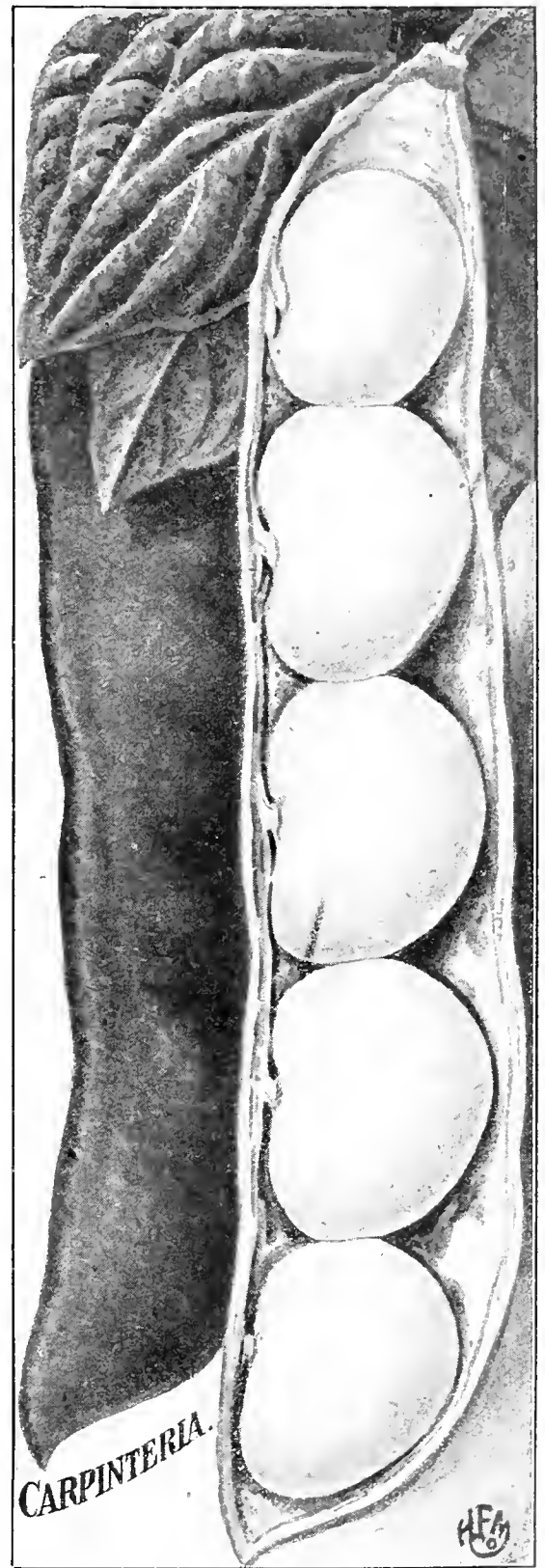

Fordhook Bush Lima

Only Varieties of Beans marked * can be supplied in ½ lb. packages.

ALL PRICES SUBJECT TO MARKET CHANGES

(ow)

• MICHELL'S CHOICE BEET SEED •

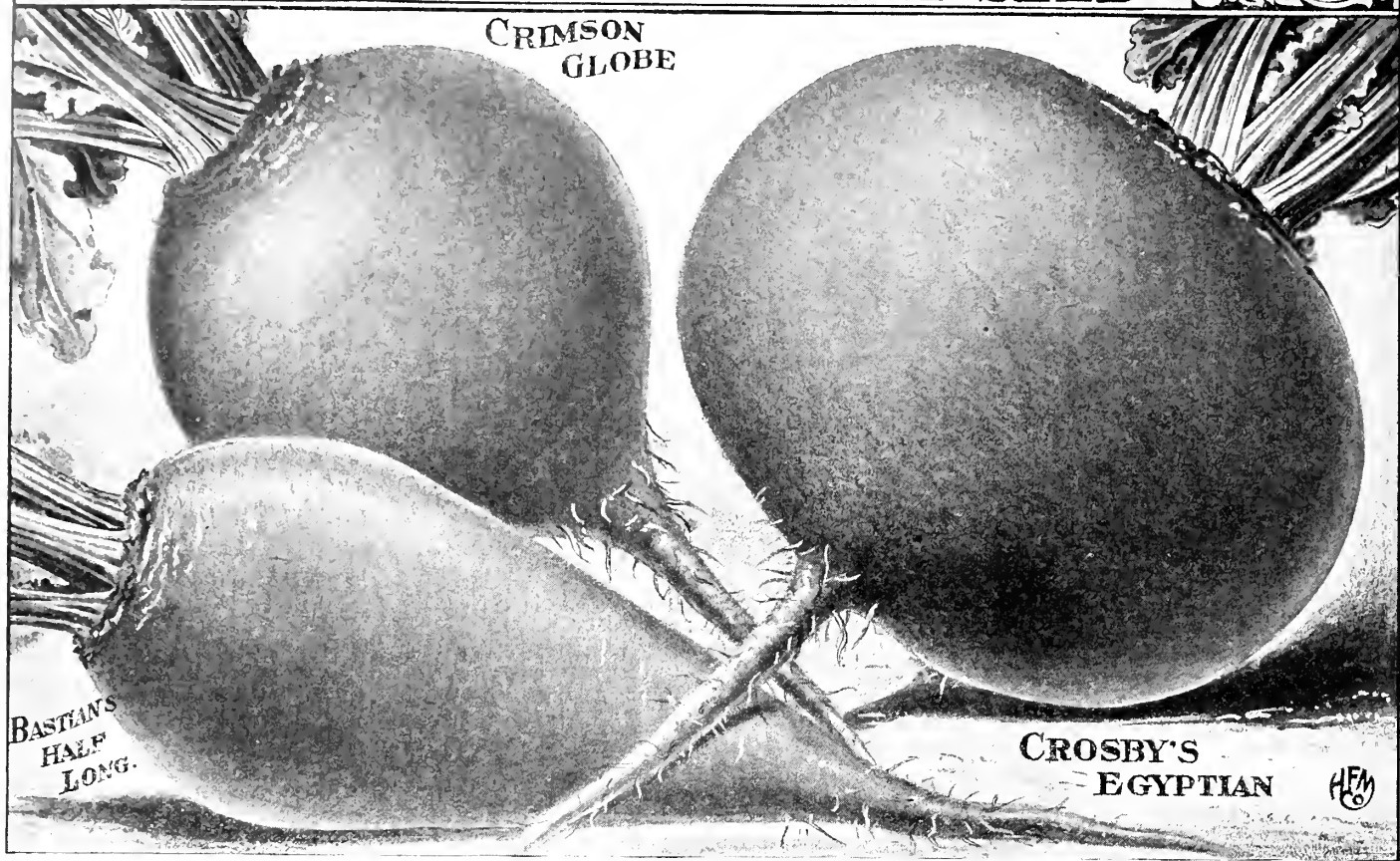

Betterave (Fr.); Salatrube (Ger.); Barbabietola (Ital.)
 One ounce will sow a row 50 ft. long; 5 lbs. per acre.
 Sow in drills one foot apart and one inch deep, as early as the ground can be worked; when the plants are large enough thin out to stand four inches apart in the row. For an early crop in hotbeds the seed should be sown in early March, while for a winter supply sow about July 10th outdoors.

Arlington Favorite. Extra early; exceedingly sweet; rich blood red. Pkt., 10c.; 15c. per oz.; ¼ lb., 50c.; \$1.35 per lb.

Bassano (Extra Early). A flat variety; flesh white and rose colored. Pkt., 10c.; 15c. per oz.; ¼ lb., 40c.; \$1.25 per lb.

Bastian's Extra Early. The best beet for market and family use; grows quite large; turnip-shaped. Pkt., 10c.; 15c. per oz.; ¼ lb., 50c.; \$1.25 per lb.

Bastian's Half Long Blood. Used extensively for winter use. Pkt., 10c.; 15c. per oz.; ¼ lb., 50c.; \$1.25 per lb.

Crimson Globe. Almost round in shape, of a rich deep red color; it has a distinct delicious flavor and is very tender; good for sowing early for forcing and summer use. Pkt., 10c.; 15c. per oz.; ¼ lb., 50c.; \$1.25 per lb.

Crosby's Egyptian. One of the earliest beets; especially desirable on account of its rich blood-red color throughout and its extreme tenderness. An early spring and winter variety and a good keeper. Pkt., 10c.; 15c. per oz.; ¼ lb., 50c.; \$1.25 per lb.

Detroit Dark Red (Michell's Special Strain). The seed of this variety is a careful re-selection from the choicest, most uniform roots; it will be found superior to the usual type of Detroit Beet and we recommend it in the highest of terms. Pkt., 10c.; 25c. per oz.; ¼ lb., 70c.; \$2.25 per lb.

Detroit Dark Red (Regular Strain). 5c. per pkt.; large pkt., 10c.; 15c. per oz.; ¼ lb., 50c.; \$1.25 per lb.

Eclipse. Perfectly smooth and round; skin and flesh intense red. An excellent sort for forcing or for planting in the garden. Pkt., 10c.; 15c. per oz.; ¼ lb., 50c.; \$1.25 per lb.

Lentz Early. Fine for sowing in hotbeds and outdoors early. It is a desirable winter variety also; blood-red. Pkt., 10c.; 15c. per oz.; ¼ lb., 50c.; \$1.35 per lb.

Michell's Ideal (New). A splendid turnip-shaped beet of rich, blood-red color; fine grained and very tender. Pkt., 10c.; 20c. per oz.; ¼ lb., 65c.; \$2.00 per lb.

Michell's Winter Keeper (New). Globe shape; rich red, tender and sweet; one of the best winter varieties. Pkt., 10c.; 20c. per ½ oz.; per oz., 35c.; \$1.10 per ¼ lb.; per lb., \$3.50.

SWISS CHARD, GIANT LUCULLUS
 Pkt., 10c.; 15c. per oz.; per ¼ lb., 50c.; \$1.25 per lb.

BEETS
Cattle Varieties or Mangel-Wurzel. (See page 25.)
BASIL (Herb). Pkt., 10c.; 20c. per ½ oz., per oz., 35c.
BORAGE (Herb). Pkt., 10c.; 20c. per ½ oz.; oz., 35c.; \$1.00 per ¼ lb.

BROCCOLI
Broccoli (Fr.); Sparklekohl (Ger.); Broculi (Ital.)
 One ounce will produce 3000 plants.
 A vegetable resembling cauliflower and often grown where the latter does not thrive. Cultural method is much the same.
White Cape. Pkt., 10c.; 35c. per ½ oz.; oz., 65c.; \$2.00 per ¼ lb.

BRUSSELS SPROUTS
Chou de Bruxelles (Fr.); Rosekohl (Ger.); Berza de Brusels (Ital.)
 One ounce will produce 3000 plants.
 Sow seed about May 15th; transplant when about 4 ins. high in rows 3 feet apart, 2 feet apart in the row. When heads begin to crowd, the lower leaves should be broken from the stem of the plant to give them plenty of room. They are best for cooking after they have had a slight frost.
Matchless Improved. 5c. per pkt.; large pkt., 10c.; 25c. per oz.; ¼ lb., 70c.; \$2.25 per lb.
Brussels Sprouts Plants (Ready in July)
 25 for 25c.; 75c. per 100 (by mail, 85c.); per 1000, \$6.00.

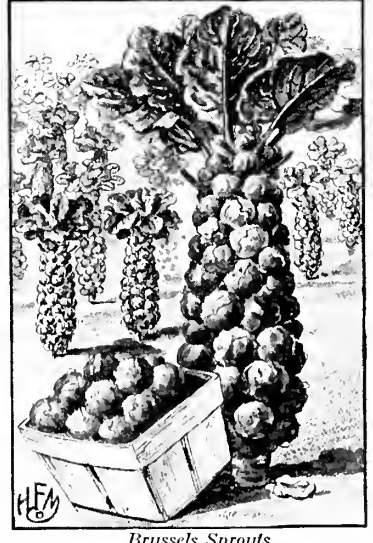

Prices of all seeds on this page include mailing charges.

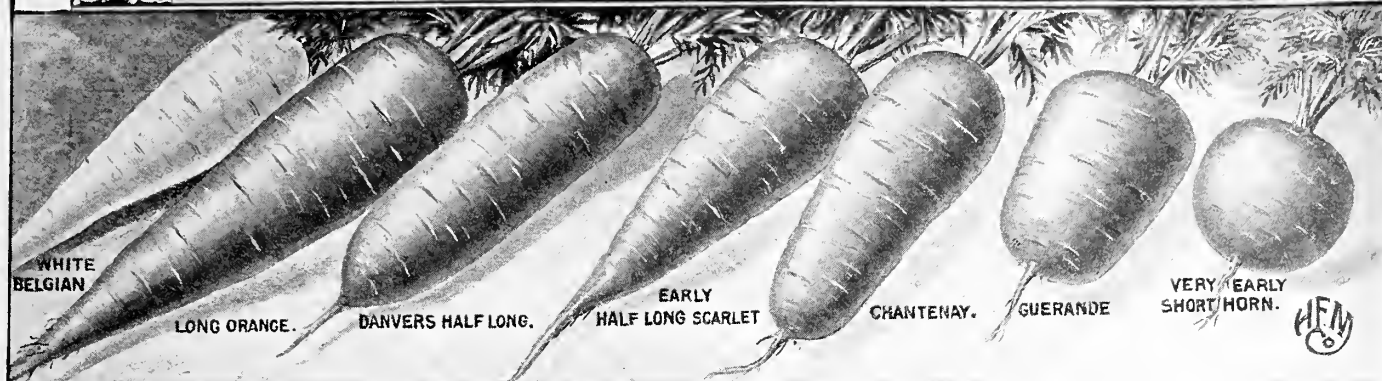

All seeds on this page mailed postpaid at quoted prices.

Carotte (Fr.); Mohrhuben (Ger.); Carota (Ital.)

One ounce will sow 100 ft. of drill; 3 to 4 lbs. per acre.

For an early crop sow as soon as danger from frost is over in rows 1 foot apart; when 2 inches high, thin out to stand 2 inches apart in the row. For a late crop sow in May or June. The long sorts should be sown early; the half-long and round sorts can be sown later.

Chantenay Half-Long. Fine orange scarlet color; very productive; especially desirable for market or home use. The flesh is tender, firm, finely grained; 5 inches long, stump-rooted. 5c. per pkt.; large pkt., 10c.; 15c. per oz.; $\frac{1}{4}$ lb., 50c.; \$1.50 per lb.

Danvers Half-Long. The best variety for general crop; rich orange color; a very heavy yielder and splendid keeper; a first-class carrot for all soils, and valuable both for table and stock; 6 to 7 inches long, stump-rooted. An extra fine strain of this favorite sort. Pkt., 10c.; 15c. per oz.; $\frac{1}{4}$ lb., 50c.; \$1.50 per lb.

Early Half-Long Scarlet. A very desirable pointed root variety, coming in between the Scarlet Horn and the Long Orange; early, of fine flavor and good color; can be sown in hotbeds for early use, for which purpose it is very good; 5 to 6 inches long. Pkt., 10c.; 15c. per oz.; $\frac{1}{4}$ lb., 50c.; \$1.50 per lb.

Early Scarlet Horn. A favorite early red variety; fine grain and good flavor; stump-rooted, about 6 inches long; ideal for soups. Pkt., 10c.; 20c. per oz.; $\frac{1}{4}$ lb., 60c.; \$2.00 per lb.

Guerande or Oxheart. A desirable variety on soils too hard and stiff for the longer growing sorts, as it is not over 3 to 4 inches long. It has a very fine flavor and is colored a rich orange. Pkt., 10c.; 15c. per oz.; $\frac{1}{4}$ lb., 50c.; \$1.50 per lb.

Improved Long Orange (Michell's Special Strain). Deep orange color; 10 inches long; good flavor; yields heavily; is of excellent table quality, and is also the best for stock feeding. 5c. per pkt.; large pkt., 10c.; 15c. per oz.; $\frac{1}{4}$ lb., 50c.; \$1.50 per lb.

Orange Beauty. A first-class carrot in every respect. This variety is a special selection of a popular sort, which it excels in every way; a beautiful shade of orange; point rooted. Pkt., 10c.; 15c. per oz.; $\frac{1}{4}$ lb., 50c.; \$1.50 per lb.

Rubicon Half-Long. The best in shape, and its deep red orange-colored flesh is of finest quality; stump-rooted. It is earlier than the Danvers and about the same length; extremely well adapted for early forcing and for growing outside. Pkt., 10c.; 15c. per oz.; $\frac{1}{4}$ lb., 50c.; \$1.50 per lb.

Very Early Short Horn Scarlet or French Forcing. An early forcing variety; small round root, not much larger than a radish. For stewing alone or when served with new peas, it is a rare delicacy hard to imagine unless you have eaten thereof. It may be sown outdoors as well as under glass. Pkt., 10c.; 20c. per oz.; $\frac{1}{4}$ lb., 65c.; \$2.25 per lb.

White Belgian. Used principally for stock, not being desirable for table; produces a long thick white root. It is also used for soiling or turning under, being a valuable humus maker. It is about 8 to 10 inches long with a green top. Pkt., 10c.; 15c. per oz.; $\frac{1}{4}$ lb., 30c.; \$1.00 per lb.

CHIVES (Schnittlauch)

Indispensable for flavoring certain dishes, imparting a mild taste of onion. The plants are hardy and will last for years; don't cut the plant too close when gathering. For winter use, lift and plant in a pot or box and place in a sunny window in the kitchen.

Seed. Pkt., 10c.; 25c. for 3 pkts.

Strong Plants. 15c. each; doz., \$1.50; \$10.00 per 100.

CORIANDER (Herb)

For flavoring, etc. Pkt., 10c.; 20c. per oz.

CHERVIL

One ounce will sow a row 25 feet long.

An aromatic plant used extensively in Europe as a salad garnishing and seasoner. It adds a flavor that is entirely its own. When chopped fine and scattered on buttered potatoes it is a rare treat. American gardeners should become familiar with this, as they are missing one of the best things that grow. Sow it in a row like parsley, which it somewhat resembles.



Double Curled Chervil

For a continuous crop, sow every two weeks; if one has heated frames or a greenhouse it can be sown under glass all winter or in hotbeds in February. It can be cut 4 or 5 weeks after sowing.

Double Curled. Pkt., 5c.; 10c. per large pkt.; $\frac{1}{2}$ oz., 15c.; 25c. per oz.; $\frac{1}{4}$ lb., 75c.; \$2.00 per lb.

CHICORY

Witloof. The roots are easily produced from seed, sown in May or June, in rows as one would Endive. They are taken up after a few hard frosts and cared for the same as Turnips or similar crops. Used only as a winter vegetable, the top part only being edible. Plant under a bench in the greenhouse or a light, dry, warm portion of a cellar in a bed of rich garden soil 12 inches deep. Place about 6 inches apart each way. The top growth remains intact, and may be cut any time after 5 inches growth. Roots should be set in the soil the same depth as they were originally in the garden. A continuous supply of this delicious winter vegetable can be had from December 1st to April 1st. A cold frame makes also an ideal place for forcing them in the late winter or early spring months. Pkt., 5c.; 10c. per large pkt.; oz., 20c.; 60c. per $\frac{1}{4}$ lb.; per lb., \$2.00.



Witloof

COLLARDS

One ounce of seed will produce 3000 plants.

These are extensively grown in the south and used as greens during the winter months. In that latitude the plant is practically hardy. The lower leaves are pulled off and used, when new ones then form on the upper part of the stem, which increases in height. Planted much like cabbage.

Georgia or Southern. 5c. per pkt.; large pkt., 10c.; 20c. per oz.; $\frac{1}{4}$ lb., 60c.; \$1.75 per lb.

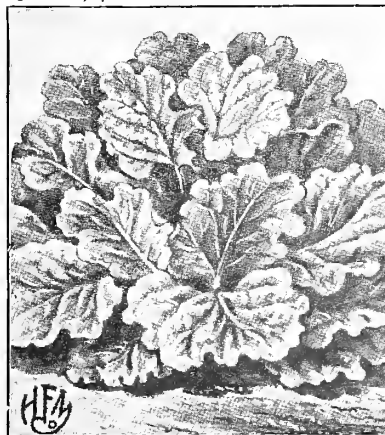

Collards



Early Jersey Wakefield

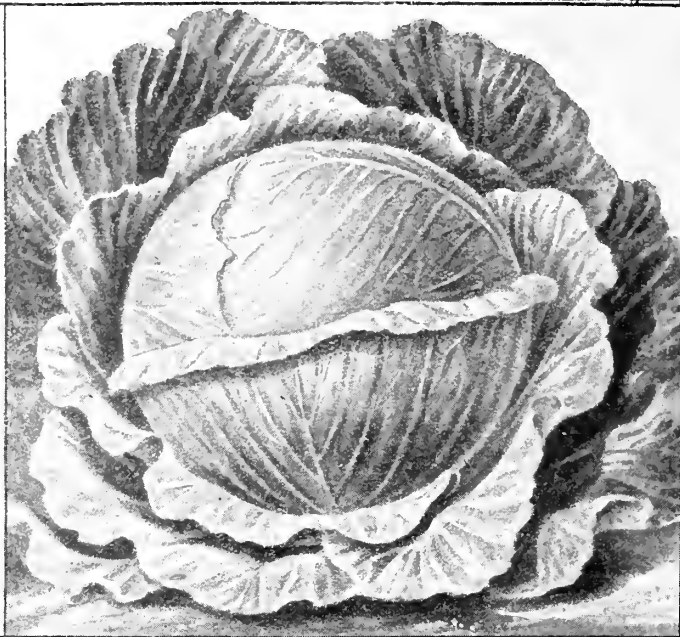

Early Summer

Chou pomme (Fr.); Kopf Kohl (Ger.); Cavolo Cappuccio (Ital.)

One ounce will produce about 3,000 plants; 4 ozs. will produce enough for an acre.

Our strains are the very best to be had, selected from specimen heads in well rogued fields. Sow seeds in January or February in hotbeds, and transplant latter part of April or early in May to open ground, or an early sowing in open ground can be made as soon as weather will permit. Set the plants in rows 2 feet apart, and 12 to 18 inches apart in the row. The second early varieties sow in April and transplant in May, or sow in May and transplant in July, setting plants in rows 3 feet apart and 2 feet in rows. Never plant cabbage in the same location two years in succession.

All seeds on this page mailed post free.

EARLY VARIETIES

All Head. The largest of the early cabbages. The head is roundish flat and remarkably solid; excellent for winter as well as early spring. Pkt., 10c.; 20c. per $\frac{1}{2}$ oz.; oz., 35c.; \$1.10 per $\frac{1}{4}$ lb.; lb., \$4.00.

Copenhagen Market. The earliest round variety in cultivation. The heads frequently weigh as much as 10 lbs. In this variety we offer a splendid sort, which should be planted by every cabbage grower. Pkt., 10c.; 20c. per $\frac{1}{2}$ oz.; oz., 35c.; \$1.10 per $\frac{1}{4}$ lb.; lb., \$4.00.

Early Jersey Wakefield (Improved Strain). The finest type of early cabbage in existence; a great improvement over the regular strain. It produces uniform pointed heads, and should be sown by every private and market gardener. The outer leaves form a protection for the heads, which enables it to be set out earlier than other sorts. 5c. per pkt.; large pkt., 10c.; 20c. per $\frac{1}{2}$ oz.; oz., 35c.; \$1.10 per $\frac{1}{4}$ lb.; lb., \$4.00.

Henderson's Early Summer. The leaves have a more bluish cast than the other cabbages; the heads are roundish flat. A fine variety for following the early types; makes a splendid solid head. Pkt., 10c.; 20c. per $\frac{1}{2}$ oz.; oz., 40c.; \$1.25 per $\frac{1}{4}$ lb.; lb., \$4.25.

Large Charleston Wakefield. Similar to the Early Wakefield, but the heads are more blunt, equally as solid, while it grows almost twice the size and matures one week later. Pkt., 10c.; 20c. per $\frac{1}{2}$ oz.; oz., 35c.; \$1.10 per $\frac{1}{4}$ lb.; lb., \$4.00.

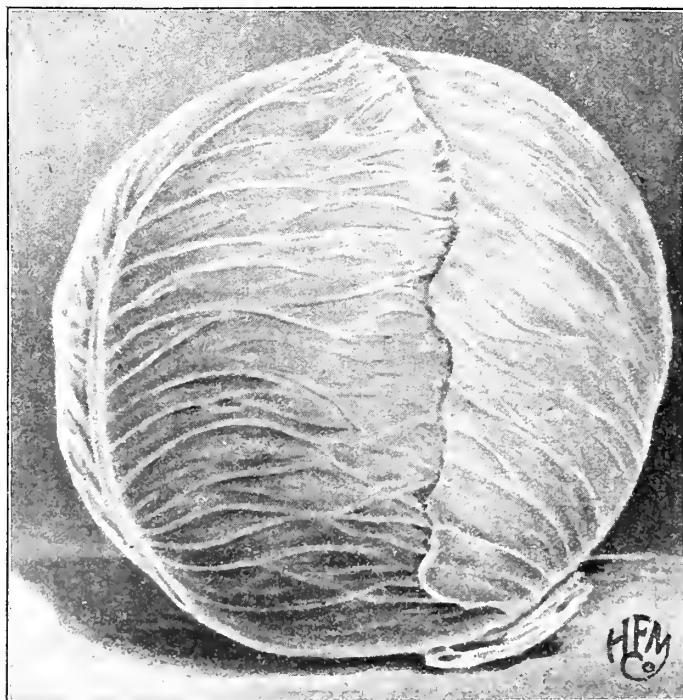

Danish Ball Head (See page 15)

CHINESE CABBAGE (Pe-Tsai)

Too much cannot be said in favor of this splendid vegetable, because it can be used in a variety of ways, namely, as a salad, raw or cooked. Pkt., 10c.; 20c. per $\frac{1}{2}$ oz.; oz., 35c.; \$1.10 per $\frac{1}{4}$ lb.; lb., \$1.00.

Testimonial on Pe-Tsai.

Chestnut Hill, Phila.

I grew in my garden some Chinese Cabbage or Pe-Tsai, as it is called. In my opinion it is a remarkable vegetable, and certainly should command a place in every garden. Some specimens I grew weighed as much as 9 $\frac{1}{2}$ lbs., they were gigantic beauties. When cooked as cabbage this vegetable has no odor and in that respect certainly has one on cabbage for merit.

EDWARD GROVES.

MICHELL'S PRACTICAL GARDEN POINTERS

Is the title of a publication we have compiled that contains a mine of information on things horticultural and agricultural. There is a free copy for you. Just say, "Send me 'Practical Garden Pointers.'" A post card will do.

A book on the Culture of CABBAGE AND CAULIFLOWER, by Allen; comprehensive, interesting and instructive, 90c. postpaid.

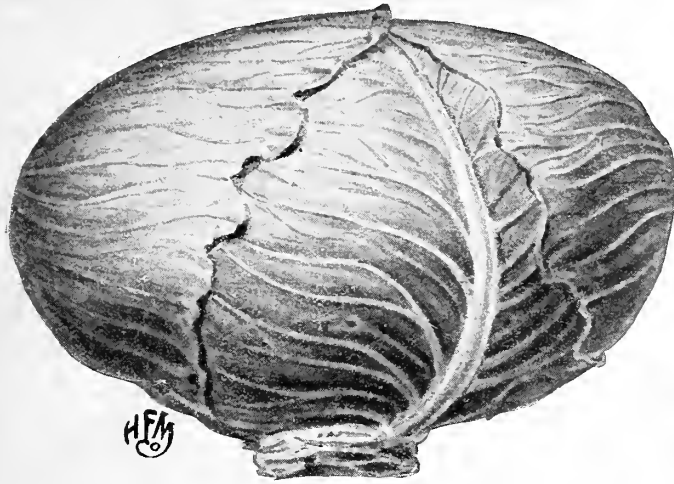

HFM

Late Flat Dutch Cabbage

LATE OR WINTER VARIETIES

All Seasons (Vandergaw). A very large head, round and solid. Valuable for late summer or winter use. Pkt. 10c.; 20c. per 1/2 oz.; oz., 35c.; \$1.10 per 1/4 lb.; lb., \$4.00.

Danish Ball-Head (Michell's Improved Strain). This excellent winter cabbage is unequalled for its keeping qualities, massiveness and weight. For boiling, cold slaw, sauer kraut, etc., it is ideal, being crisp, tender and sweet. One of its virtues is that it does well under most any condition of moisture or drought; heads seldom burst. See illustration, page 14. Pkt., 10c.; 20c. per 1/2 oz.; oz., 35c.; \$1.10 per 1/4 lb.; lb., \$4.00.

Late Flat Dutch (Improved Strain). This has been selected especially for our trade, the seed being taken from the finest types of heads which are selected for solidity and uniformity. In a row or field of this strain every head appears uniform and its excellence is apparent. There is no better keeping cabbage in existence, being very solid. Pkt., 5c.; 10c. per large pkt.; 1/2 oz., 20c.; 35c. per oz.; 1/4 lb., \$1.00; \$3.75 per lb.

Perfection Drumhead Savoy. A beautifully crimped-leaved sort; color, a deep glossy green. The head is almost round. Savoy cabbage is distinctly flavored, being much sweeter than the other kinds. We recommend it as being one of the best cabbages of its kind grown for either market or home use. Pkt., 10c.; 20c. per 1/2 oz.; oz., 35c.; \$1.10 per 1/4 lb.; lb., \$4.00.

Red Dutch. A red variety, used extensively for pickling. When cooked with a little port wine and sugar added to it, makes a dish fit for a king. For cold slaw it has merits over the white kinds. It is principally used for winter, keeping well until spring. Pkt., 10c.; 20c. per 1/2 oz.; oz., 35c.; \$1.00 per 1/4 lb.; lb., \$3.50.



Michell's Earliest Snowstorm Cauliflower

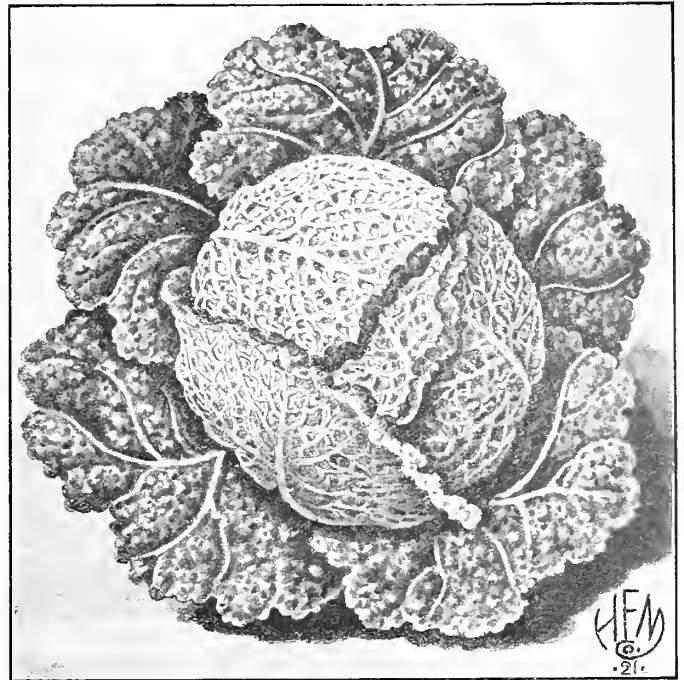

HFM
21

Perfection Drumhead Savoy Cabbage

PE-TSAI (Chinese or Celery Cabbage)

This resembles in appearance and growth a head of Cos Romaine or Celery Lettuce. The heads are very firm, almost like cabbage. The flavor is delightful, not at all like cabbage, but rather on the order of Witloof Chicory or French Endive. Can be planted as a spring or autumn crop. May be forced in a cold frame. The plants are handled much like lettuce, except that they should be set from 15 to 18 inches apart, the rows 2 to 2 1/2 feet apart. Pkt., 10c.; 20c. per 1/2 oz.; oz., 35c.; \$1.10 per 1/4 lb.; lb., \$4.00.

CABBAGE PLANTS

	100	1000
Early Sorts. Hot bed grown... Add 15c.	\$0.60	\$5.00
Early Sorts. Cold-frame grown... per 100	1.00	7.50
Late Sorts. Field Grown..... by mail60	5.00

CAULIFLOWER

Choux-Fleurs (Fr.); Blumenkohl (Ger.); Cavol Fiora (Ital.)

One ounce of seed will produce about 3,000 Plants.

Sow seeds in hotbeds or window boxes in February or March and transplant in cold frames. When hard frosts are over plant outdoors. For second crop, sow in April and set out in May. For late crop, sow in June and set out in July. Plants should be set in rows 3 feet apart, 2 feet apart in the row.

Danish Giant. An ideal variety for summer use; stands drought and heat better than other sorts; heads snow white. Pkt., 25c.; 50c. per large pkt.; 1/4 oz., \$1.00; \$1.75 per 1/2 oz.; oz., \$3.00.

Early Snowball. For either forcing under glass in cold frames or outdoor spring planting, producing magnificent medium size white heads. Pkt., 25c.; 50c. per large pkt.; 1/4 oz., 85c.; \$1.50 per 1/2 oz.; oz., \$2.75.

Half Early Paris. A small head; suited to growing outdoors only. Pkt., 10c.; 50c. per 1/4 oz.; 85c. per 1/2 oz.; oz., \$1.50.

Michell's Earliest Snowstorm. Colossal heads of purest white, averaging often 10 inches in diameter; especially desirable for its earliness under glass, but does equally well in late spring, summer, or autumn outdoors. Pkt., 25c.; 50c. per large pkt.; 1/4 oz., \$1.00; \$1.75 per 1/2 oz.; oz., \$3.00.

Michell's Special Strain Selected Erfurt. One of the earliest varieties; head not as large as the Snowstorm sort. Pkt., 25c.; 50c. per large pkt.; 1/4 oz., 85c.; \$1.50 per 1/2 oz.; oz., \$2.75.

CAULIFLOWER PLANTS (Ready April 1st)

	Dozen	100
Snowball variety only. Spring plants from hotbeds.	\$0.25	\$1.50
Snowball variety only. Pot-grown plants75	5.00

Pot-grown cauliflower plants cannot be sent by parcel post successfully. If hotbed plants are wanted by parcel post, add 5c. per doz. or 15c. per 100 for postage.

Caraway (Herb). For flavoring, etc. Pkt., 10c.; 20c. per oz.

Catnip (Herb). For making tea, a cat tonic, etc. Pkt., 15c.

MICHELL'S CHOICE CELERY

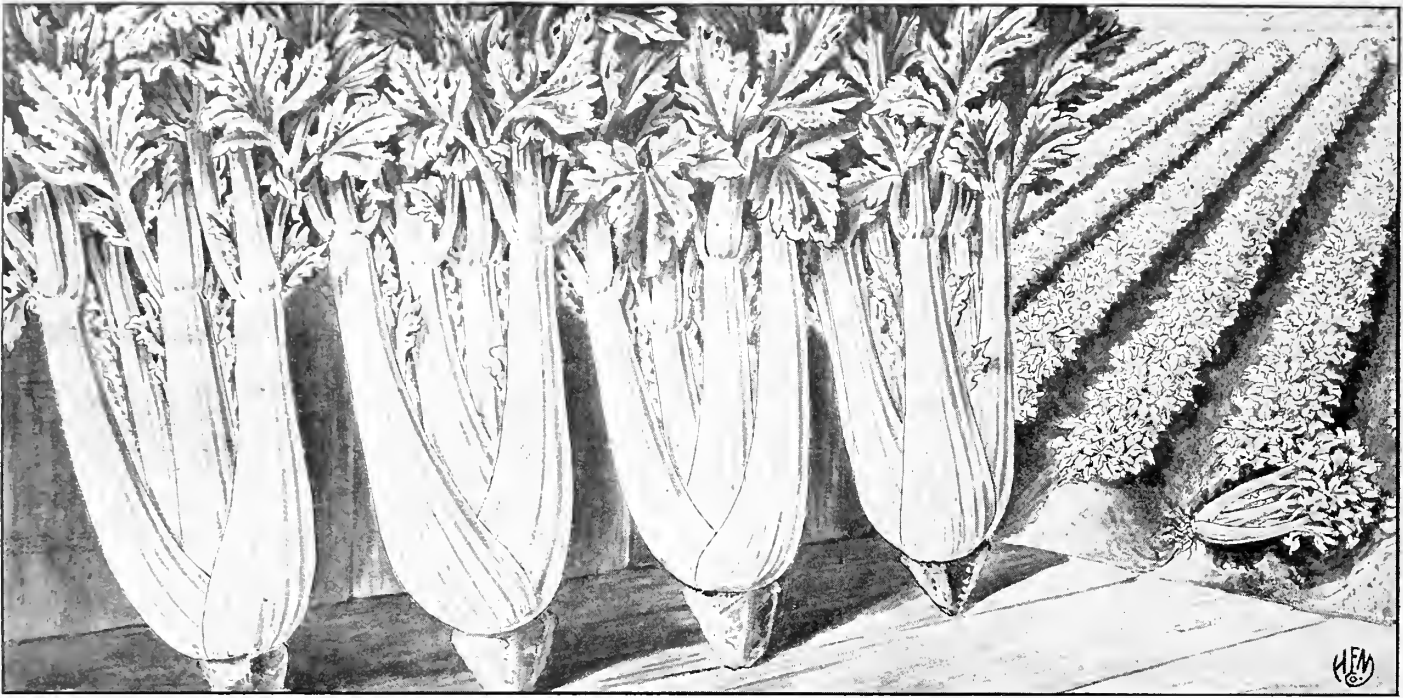

Michell's Easy Blanching Celery

Celeri (Fr.); Sellerie (Ger.); Sedano (Ital.)

One ounce of Seed will produce 3000 to 5000 plants; half-pound is sufficient for one acre.

Sow in hotbeds in March or in open ground in April. See that no weeds infest the seed bed; when 3 inches high transplant in a bed outdoors in rows 3 inches apart each way; let them remain there until July when they should be planted where they are to mature, in rows 3 feet apart, 6 inches apart in the row. Celery Plants if topped a few times before and when transplanted into their permanent growing place will make shorter, stockier plants. **Seeds offered on this page mailed at quoted prices.**

EARLY VARIETIES

Easy Blanching (*Private Stock, Penna. Grown*). This is a very much improved type of Easy Blanching Celery, being superior in every way. The flavor is delicious, stalk very large and fine grained, the color all that can be desired. Plants set out in June are fully matured and ready for use the early part of September. The seed is grown for us by one of the leading Market Gardeners of Penna. who has made a specialty of celery for many years. See page 4A. Pkt., 15c.; 85c. per ½ oz.; oz., \$1.50; \$5.00 per ¼ lb.

Easy Blanching. A splendid first early variety, being ready in October; produces enormous stalks which are very crisp. Pkt., 10c.; 20c. per ½ oz.; oz., 40c.; \$1.50 per ¼ lb.

Golden Self Blanching (*French Grown Seed*). One of the earliest and most productive sorts. The beautiful golden-colored stalks attain a height of 18 inches, which are never pithy, and of excellent flavor; ready in October, but may be kept for early winter use. Pkt., 15c.; 75c. per ½ oz.; oz., \$1.50; \$5.00 per ¼ lb.

Golden Self Blanching (*American Grown Seed*). Pkt., 10c.; 25c. per ½ oz.; oz., 50c.; \$1.75 per ¼ lb.

New York (*New*). One of the best in cultivation, very large and solid and of excellent qualities. Self blanching. Pkt., 10c.; 20c. per ½ oz.; oz., 35c.; \$1.25 per ¼ lb.

Pink Plume. A very solid, crisp, desirable sort; the stalks when blanched are a beautiful rose-pink. Pkt., 10c.; 20c. per ½ oz.; oz., 35c.; \$1.25 per ¼ lb.

White Plume (*Michell's Private Stock*). The standard early celery for market and the home garden. The stalks and heart, which blanch very quickly to almost a pure white, are very crisp and brittle. It can be used early in November and is of the finest quality. Our strain of seed is very superior in every way. 5c. per pkt.; large pkt., 10c.; 20c. per ½ oz.; oz., 35c.; \$1.25 per ¼ lb.

LATE WINTER VARIETIES

Emperor (*New*). Dwarf growing; very brittle and of extra fine flavor; a good winter keeper. Pkt., 10c.; 25c. per ½ oz.; oz., 50c.; \$1.50 per ¼ lb.

Giant Pascal. This is in its prime for use during February and March, and can be used well up into spring. Pkt., 10c.; ½ oz., 15c.; 30c. per oz.; ¼ lb., 85c.; \$2.50 per lb.

New Columbia. A new variety of great merit; a medium tall sort, producing a large, heavy stalk; splendid keeper. Pkt., 10c.; 20c. per ½ oz.; oz., 35c.; \$1.00 per ¼ lb.

Winter King. Perfectly solid, crisp and of delicious flavor; good keeper. Pkt., 10c.; 20c. per ½ oz.; oz., 35c.; \$1.25 per ¼ lb.

Winter Queen. A medium tall, solid variety; will retain its qualities long through the winter. The heart is very full and large. 5c. per pkt.; large pkt., 10c.; 20c. per ½ oz.; oz., 35c.; \$1.10 per ¼ lb.

CELERY PLANTS (Ready in July)

Leading varieties. Per 100, 75c.; \$6.00 per 1000.

CELERY FOR FLAVORING (Not for Sowing)
10c. per oz.; ¼ lb., 20c.; 50c. per lb.

CELERY PAPER

For winter protection; 500 sq. ft. per roll. Price upon application.

CELERY TAPE

Fast red, in 1000-yard spools, \$4.50 per spool.

CELERICAC

This vegetable is used for two purposes: the leaves are cut when young and used to flavor soups and meats; the roots are boiled, sliced, cooled, and served as a salad.

Giant Prague. Pkt., 10c.; 20c. per oz.; ¼ lb., 60c.; \$2.00 per lb.

CHAMOMILE

(Herb)

Pkt., 10c.; 30c. per ½ oz.; per oz., 50c.

CITRON

This will be found described further under the heading of melons. Pkt., 5c.; 10c. per large pkt.; oz., 15c.; 40c. per ¼ lb.; per lb., \$1.25.

CHARD. See *Swiss Chard*, page 34

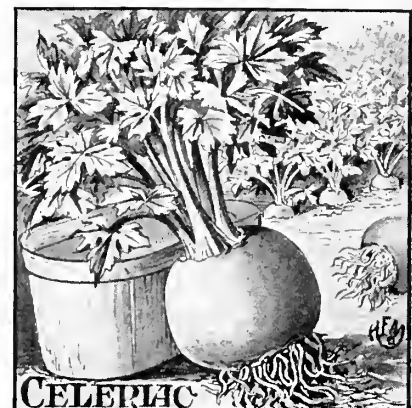

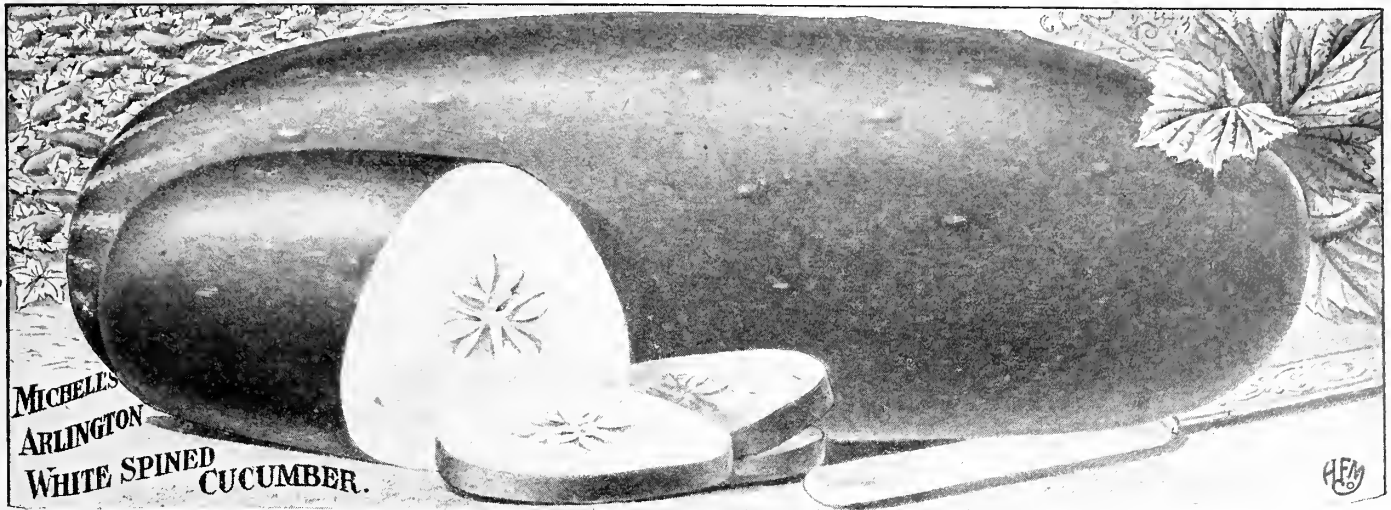

Concombre (Fr.); Gurken (Ger.); Cetriolo (Ital.). One ounce of seed will plant 60 hills; 2 to 3 pounds per acre.

Plant when the ground has become thoroughly warmed, in hills 4 feet each way, 8 seeds in a hill; when the second set of leaves have formed thin out to 4 plants in a hill. A type of beetle attacks this crop occasionally, which can be conquered by spraying the vines with Pyrox or Arsenate of Lead; when this is used always wash the fruits thoroughly before using. If the foliage is attacked beneath, by aphid or green fly, a spraying with Black Leaf 40 is usually very effective.

Davis' Perfect. This remarkably fine variety is suited for growing under glass as well as outdoors. The fruits are uniform in shape and size, often measuring 10 to 12 inches in length. Its color is dark green all over, and it is quite smooth and very productive. 5c. per pkt.; large pkt., 10c.; 20c. per oz.; $\frac{1}{4}$ lb., 50c.; \$1.50 per lb.

Early Fortune. One of the finest cucumbers of the White Spine type; medium length, and dark green in color, which it holds for a long time after picking; flesh white and very crisp. Pkt., 10c.; 20c. per oz.; $\frac{1}{4}$ lb., 50c.; \$1.50 per lb.

Evergreen. The name is derived from the feature of its dark green color-retaining qualities; thick fruits, measuring about 8 to 9 inches long. Pkt., 10c.; 20c. per oz.; $\frac{1}{4}$ lb., 50c.; \$1.50 per lb.

Gherkin or Burr Cucumber. For pickling only; the small fruits are roundish, about 2 inches long; very prickly when green. Pkt., 10c.; 15c. per $\frac{1}{2}$ oz.; oz., 30c.; 85c. per $\frac{1}{4}$ lb.; lb., \$2.75.

Japanese Climbing. A trellis variety used for shade as well as eating purposes. The vine is very ornamental, and produces extra long light green fruits in abundance. Pkt., 10c.; $\frac{1}{2}$ oz., 15c.; 25c. per oz.; $\frac{1}{4}$ lb., 75c.; \$2.25 per lb.

Jersey Pickle or Green Prolific. This sort can be used for slicing but is best for pickling on account of its size, which averages 5 inches in length; makes ideal "Dill Pickles" as sold extensively in the delicatessen stores. Pkt., 10c.; 20c. per oz.; $\frac{1}{4}$ lb., 50c.; \$1.50 per lb.

All seeds on this page mailed post free at prices quoted.

Long Green Turkey. This is one of the large varieties, used principally for slicing. Its dark color makes it desirable for market. The vines are very vigorous and productive; the fruits are formed almost as early as the short sorts; they are firm, crisp and have a fine flavor. Pkt., 10c.; 20c. per oz.; $\frac{1}{4}$ lb., 50c.; \$1.50 per lb.

White Spined (Michell's Arlington Improved). This cucumber is absolutely perfect in form, color, size and productiveness, and is therefore the leading sort, not only for the home or market garden, but also with those who make a specialty of growing them under glass. The fruit is smooth, deep green to the tip and measures uniformly 8 inches in length. It has few seeds, making it a valuable variety for slicing or pickling. A splendid keeper, retaining its color remarkably; the seed we offer is an extra selection. Pkt., 10c.; 20c. per oz.; $\frac{1}{4}$ lb., 50c.; \$1.50 per lb.

ENGLISH CUCUMBERS

These are splendid for growing in hotbed frames during the summer months, in preference to the open garden ground. They can thus be started earlier and protected during cool nights, as they are more tender than the regular outdoor varieties. They may also be grown under glass in greenhouses during the winter, producing enormous fruits, generally 18 to 24 inches long and 3 inches in diameter. They have a delicate flavor and possess very few seeds; for slicing, no other sorts can approach them.

Lockie's Perfection, Sion House, Telegraph, Tender and True. Per packet of 12 seeds of either of the 4 sorts above, 25c. per pkt.; 100 seeds, \$1.75.

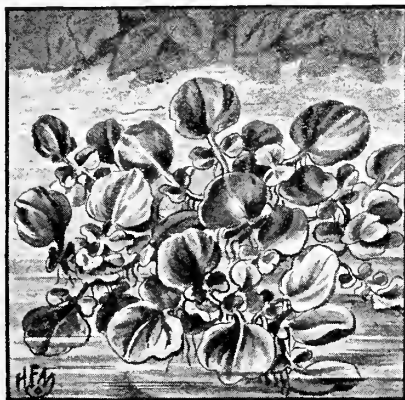

Water Cress

WATER CRESS

This desirable cress may be sown early in spring near the brink of a pond of spring water or piece of running water. Just scatter the seed and it will sprout and grow with wondrous rapidity; once established it remains for years, reseeding itself.

True Erfurt. Pkt., 10c.; 25c. per $\frac{1}{2}$ oz.; oz., 50c.; \$1.50 per $\frac{1}{4}$ lb.

GARDEN CRESS

Sow thickly in early spring in drills one foot apart, and follow every two weeks, up to August 1st, with a new sowing, as it quickly runs to seed. Its very desirable pungent taste is acceptable to most any one who is fond of garden greens. It is eaten prepared with either a little salt and vinegar, or without. Makes a very tasty salad.

Extra Curled. Pkt., 5c.; 10c. per oz.; 25c. per $\frac{1}{4}$ lb.; lb., 85c.

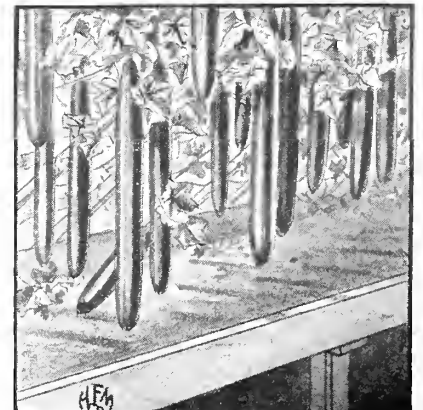

English Greenhouse Cucumbers

ALL PRICES SUBJECT TO MARKET CHANGES

(ow)

18 **MICHELL'S SELECTED SUGAR CORN** 3

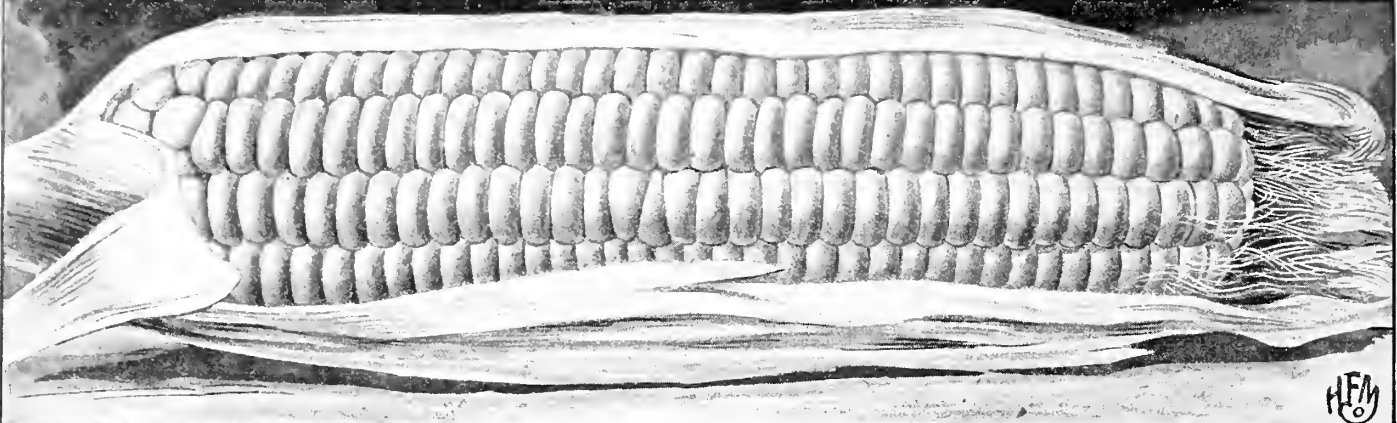

Golden Bantam

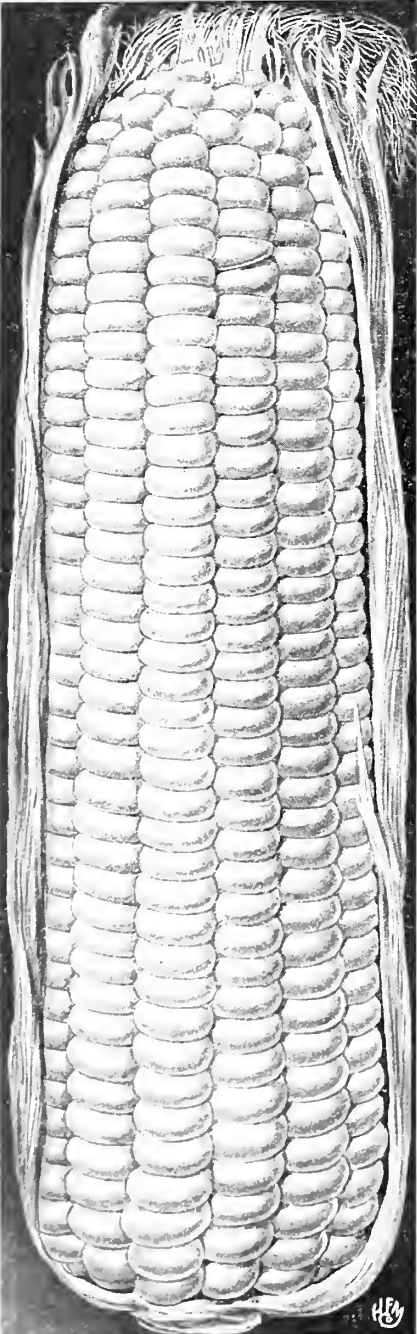

Mitchell's Delicious (See page 19)

Mais (Fr.); Welschkorn (Ger.); Grano Turco (Ital.)

1½ lbs. will plant about 200 hills; 12 to 15 lbs. will plant an acre.

Plant once a week from the time the ground is permanently warm until July 15th, 6 to 8 grains, in hills three feet apart each way, or in rows three feet apart; if the latter, thin out so the plants stand 12 inches apart; if left in hills, thin out when 4 inches high to 3 to 4 plants to the hill. Early varieties should be planted for a late crop to be sure of maturity.

NOTE.—If corn is wanted by parcel post, please allow for mailing as per parcel post table on page 1.

Adams Extra Early. Pure white, medium sized ears, not entirely sweet. 10c. per pkt.; lb., 25c.; 40c. per 2 lbs.; 5 lbs., 90c.; \$1.60 per 10 lbs.; 25 lbs., \$3.50.

Bantam Evergreen. A yellow Sweet Corn noted for its excellent qualities; much larger than Golden Bantam and claimed to be more productive, it is also claimed to be considerably earlier (some say two weeks) a splendid variety for mid and late season planting. 10c. per pkt.; lb., 30c.; 50c. for 2 lbs.; 5 lbs., \$1.10; \$2.00 for 10 lbs.; 25 lbs., \$4.25.

Early Evergreen. This variety is closely allied to Stowell's in shape, flavor and style, but is much earlier; produces large well-shaped ears, with deep grains. 10c. per pkt.; lb., 30c.; 50c. for 2 lbs.; 5 lbs., \$1.10; \$2.00 for 10 lbs.; 25 lbs., \$4.00.

Early Mayflower. Slightly earlier than Golden Bantam. Stalk about 4 feet high; ears exceptionally long and well filled for an early Corn. The ears average 7 inches in length; grains tender and of excellent flavor. 10c. per pkt.; lb., 35c.; 65c. for 2 lbs.; 5 lbs., \$1.25; \$2.25 for 10 lbs.; 25 lbs., \$5.00.

***Golden Bantam.** While yellow in color, this is one of the sweetest and earliest corns. Ears medium size; kernels tender and delicious. The plant is of dwarf growth; we recommend it very highly for the home garden. 10c. per pkt.; ½ lb., 20c.; 30c. per lb.; 2 lbs., 50c.; \$1.10 per 5 lbs.; 10 lbs., \$2.00; \$4.00 for 25 lbs.

Golden Cream. This variety is the result of a cross between Country Gentleman and Golden Bantam and combines the excellent qualities of both. When picked ripe is a very light yellow; after being cooked it turns darker. 10c. per pkt.; lb., 30c.; 50c. per 2 lbs.; 5 lbs., \$1.10; \$2.00 for 10 lbs.; 25 lbs., \$4.00.

Howling Mob. A splendid sort for the market gardener, as well as for home use. Might be classed worm-proof, since the husk covers the ear completely and in a tight fashion. It follows the Adams Extra Early types, which are not near so sweet. 10c. per pkt.; lb., 30c.; 55c. for 2 lbs.; 5 lbs., \$1.20; \$2.00 for 10 lbs.; 25 lbs., \$4.25.

PLEASE NOTE.—Only varieties of Sugar Corn marked * can be supplied in ½ lb. packages.

Ideal. The grower of this variety has been carefully selecting it for many years; it is an exceedingly early and large yielder. It is not quite as sweet as some other varieties, it is though, nevertheless, well flavored, and its extra early feature outweighs all other points against it. It comes in sooner than other white-kernel varieties like Adams Extra Early. 10c. per pkt.; lb., 25c.; 40c. for 2 lbs.; 5 lbs., 90c.; \$1.60 for 10 lbs.; 25 lbs., \$3.50.

Kendel's Early Giant. Large ears, deep grain, well flavored and extra sweet. The ears are very cylindrical. An ideal sort for the first and last planting. Just the variety to grow for market garden trade, it gives the housewife a lot of splendid quality for her money. 10c. per pkt.; lb., 25c.; 45c. per 2 lbs.; 5 lbs., \$1.00; \$1.85 for 10 lbs.; 25 lbs., \$4.00.

***Stabler's Extra Early.** This is the standard sort for the home garden. The large ear is well arrayed with even grains, which cook pure white and are very tender. 10c. per pkt.; ½ lb., 20c.; 30c. per lb.; 2 lbs., 50c.; \$1.10 per 5 lbs.; 10 lbs., \$2.00; \$4.00 per 25 lbs.

TWO NEW CORNS

Golden Giant. This corn has been widely advertised by the originator, Dr. De Lue, of Boston, and its sale has been phenomenal. The ear is about 11 inches long, well filled out from butt to tip, and very symmetrical. Deep golden yellow ears and plant much larger than Golden Bantam, while it is also in some localities earlier. The kernels are staged regularly on the cob, and are fairly large. Excellent quality and a heavy yielder. 10c. per pkt.; per ½ lb., 25c.; 50c. per lb.; 2 lbs., 85c.; \$1.90 per 5 lbs.; 10 lbs., \$3.50; \$7.50 per 25 lbs.

Sugar Kernel. A splendid new variety, that is fully described and illustrated on page 4A. 10c. per pkt.; per lb., 60c.; \$1.00 for 2 lbs.; 5 lbs., \$2.25; \$4.25 for 10 lbs.; 25 lbs., \$10.00.

MICHELL'S SELECTED SUGAR CORN.

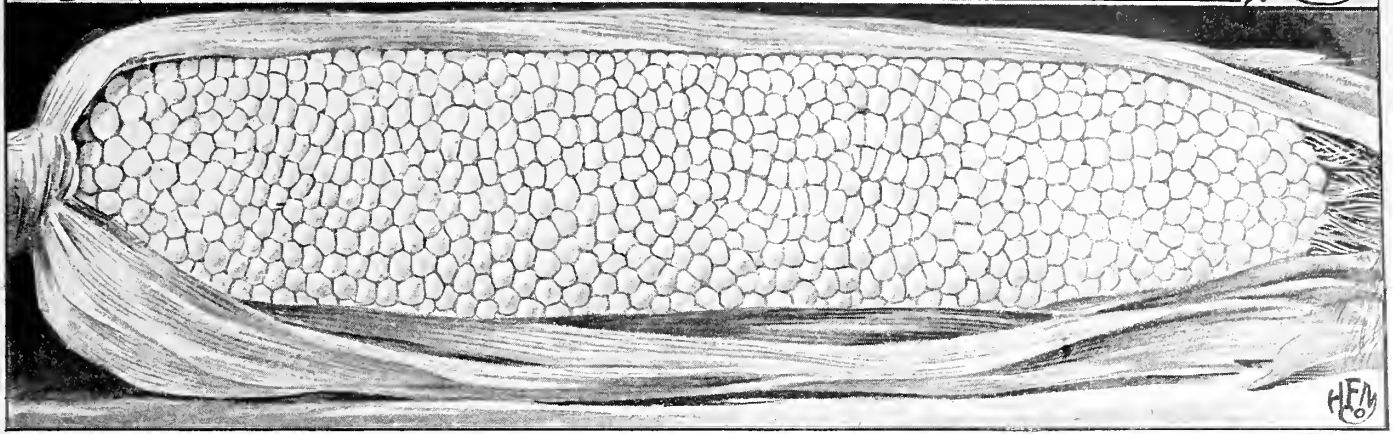

Country Gentlemen (Michell's Improved Strain)

MEDIUM OR LATE VARIETIES

Black Mexican. A medium late variety, reputed to be without exception the sweetest corn grown; while the grains are young they cook white, as the ear becomes older it cooks a violet shade on the outside, but in either stage of growth it is desirable. The ears are medium-sized and are produced abundantly. Pkt., 10c.; 30c. per lb.; 2 lbs., 50c.; \$1.10 per 5 lbs.; 10 lbs., \$2.00; \$4.00 per 25 lbs.

***Country Gentleman** (Michell's Improved Strain). A distinct sort, with deep, fine grains which are staged irregularly on the cob. In sweetness it is unapproached, and for this reason it should recommend itself to every planter. The ears are large and borne on stalks about 6 feet high; a very productive variety and desirable for either home or market use. Our Improved Strain is a careful selection of the finest type of ears from stalks making a larger than usual yield. Pkt., 10c.; 20c. per ½ lb.; lb., 30c.; 50c. per 2 lbs.; 5 lbs., \$1.10; \$2.00 for 10 lbs.; 25 lbs., \$4.00.

Late Mammoth. Gigantic ears of extra fine quality, produced in great quantity. This is the latest maturing and largest of all sweet corns. Pkt., 10c.; 25c. lb.; 2 lbs., 45c.; \$1.00 per 5 lbs.; 10 lbs., \$1.85; \$4.00 per 25 lbs.

Little Gem or Shoe Peg (Ne Plus Ultra).

This variety is closely allied to Country Gentleman and resembles it so closely that it is difficult to separate the two. Pkt., 10c.; 30c. per lb.; 2 lbs., 50c.; \$1.10 per 5 lbs.; 10 lbs., \$2.00; \$4.00 per 25 lbs.

Michell's Delicious. Some twenty years ago it was selected by an old-time Philadelphia gardener, who bred it until he had it perfect. Ever since we acquired control thereof we have placed it with our best sugar corn grower in New England, with instructions to grow it for us exclusively and keep re-selecting it. The ears are well filled, medium in size and mature after the early varieties. Pkt., 10c.; 30c. per lb.; 2 lbs., 50c.; \$1.10 per 5 lbs.; 10 lbs., \$2.00; \$4.00 per 25 lbs.

***Stowell's Evergreen** (Michell's Improved Strain). The best late corn grown. The ears are extra large, and produced in great abundance; stalks often grow to a height of 7 feet. In sweetness it is unexcelled, and for this reason it is the great favorite of the market and home gardener. Our strain has been re-selected and represents a distinct advance in every way of this splendid variety. Pkt., 10c.; 20c. per ½ lb.; lb., 30c.; 50c. per 2 lbs.; 5 lbs., \$1.10; \$2.00 for 10 lbs.; 25 lbs., \$4.00.

Only varieties of Sugar Corn marked * can be supplied in ½ lb. packages.

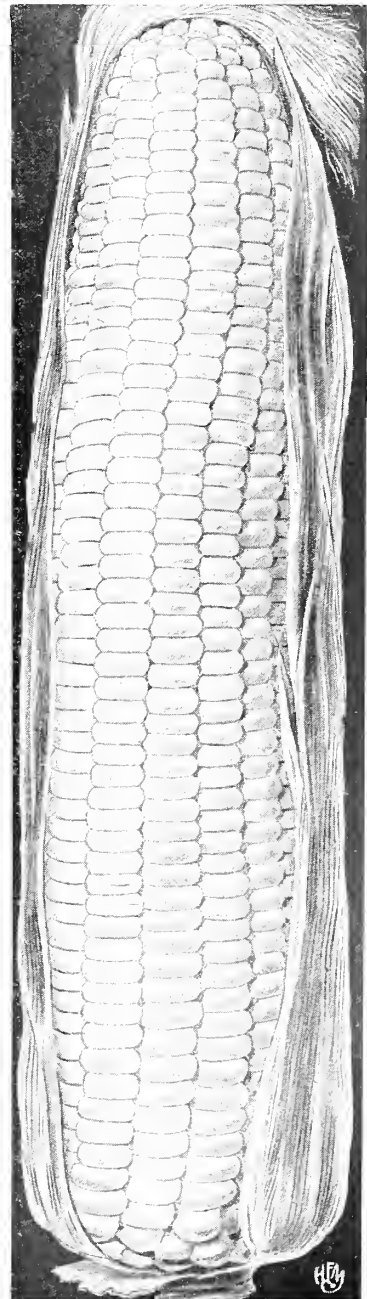

Stowell's Evergreen

NOTE.—If corn is wanted by parcel post, please allow for postage as per parcel post table on page 1.

CORN POPPERS

Made of the best quality wire. Price includes handle and lid. 1 qt. size, 25c. each; 2 qt. size, 35c. each.



POP CORN (Shelled)

There is hardly a home in this vast country where the popping of corn is not considered an excellent pastime during the long, dreary evenings of winter. When popped, buttered and sugared it is not only delicious, but healthful. Not all popcorn is in the right condition for popping. What we offer, however, can be relied upon for planting and popping.

Queen's Golden (Pops white). Lb., 15c.; 40c. for 3 lbs.

White Rice. Lb., 15c.; 40c. for 3 lbs.

CORN SALAD (Fetticus)

Mache Ronde (Fr.); **Ackersalat** (Ger.).

This is principally sown for a supply of greens during winter and early spring months. Sow in September broadcast; when cold weather approaches, cover with a litter of leaves or long manure or straw, and upon approach of spring the covering can be taken off entirely. It can also be gathered on mild days during winter.

Large Leaved, Round Seeded. 5c. per pkt.; large pkt., 10c.; 15c. per ½ oz.; oz., 25c.; 65c. per ¼ lb.; lb., \$2.00.

ALL PRICES SUBJECT TO MARKET CHANGES

(ow)

MICHELL'S VEGETABLE SEEDS

All seed on this page mailed postpaid to purchaser at prices quoted.

DANDELION

Pissenlit (Fr.); Loewenzahn (Ger.); Dente di leone (Ital.)

While this name applies to what is generally considered the most obnoxious of weeds, in cultivated form it is a valuable vegetable, grown in quantities for the New England markets, where it is prized as the first spring greens. The leaves, which are very fleshy, are boiled and served hot or cold; not alone is it appetizing, but very healthy and highly recommended by physicians. Seed should be sown in spring, thickly, in a bed in the garden, where the plants should remain for the season; late in the fall cover the bed with a movable sash, or leaves, or salt hay for protection. To be real tender it must be used very early in the spring, after which the bed should be destroyed, unless it is desired to make wine from the flowers.

Thick Leaved or Cabbaging. Pkt., 10c.; 35c. per ½ oz.; oz., 65c.; \$2.50 per ¼ lb.

DILL. (Herb). (Annual)

Used extensively for culinary purposes and for putting with cucumbers when pickling, producing the famous "Dill Pickles." Pkt., 10c.; 20c. per oz.

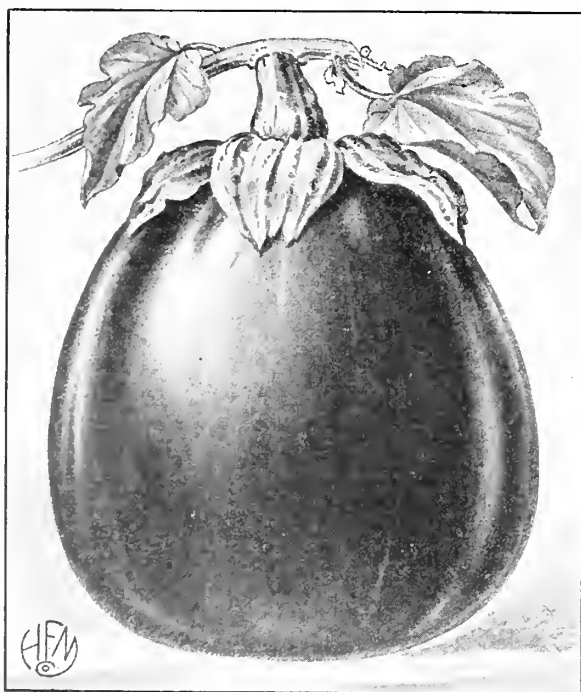

Egg Plant. *Black Beauty*

EGG PLANT

Aubergine (Fr.); Eierpflanze (Ger.); Petonciano (Ital.)
One ounce will produce about 2000 plants.

Sow seed in March in hotbeds, and when 3 inches high transplant into small pots or otherwise. Plant outdoors in May or June or after the weather has become permanently warm, in rows 3 feet apart, with the plants set 2 feet apart in the row.

Black Beauty. An extra early, large variety, almost black in color; very prolific and with few seeds. Pkt., 5c.; 10c. per large pkt.; ½ oz., 25c.; 50c. per oz.; ¼ lb., \$1.75.

Michell's New York Improved. An old standard; quite large and more elongated than the Black Beauty, with a rich purple color. Pkt., 10c.; ½ oz., 25c.; oz., 50c.; ¼ lb., \$1.75.

EGG PLANT PLANTS

(Ready May 15th)

New York Improved, Black Beauty. Pot-grown. 10c. each; doz., \$1.00; \$7.00 per 100. Egg Plants cannot be mailed satisfactorily.

FENNEL (Herb). Pkt., 10c.; 15c. per ½ oz.; oz., 25c.

FENNEL, FLORENCE (Herb). Pkt., 10c.; 20c. per ½ oz.; oz., 40c.

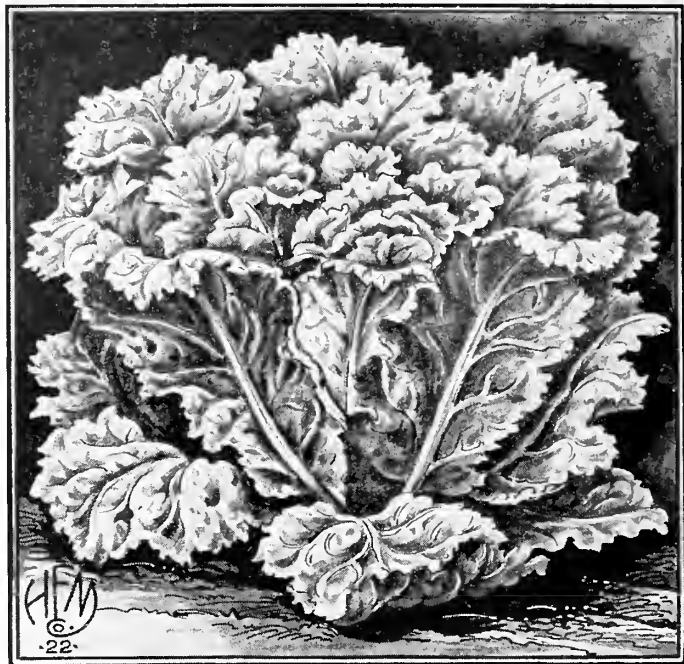

Endive, *Broad Leaved Batavian*

ENDIVE

Chircoree (Fr.); Endivien (Ger.); Indivia (Ital.)

One ounce will sow a row of 200 ft.

Sow from June to August in shallow drills, and when 2 inches high thin out so the plants stand 10 inches apart. When fairly well developed, toward autumn, tie the plants together at the top with twine, but do this at a time when the leaves are dry. This is called the blanching process. If the plants are protected they may be left outdoors till Christmas. If wanted for later use they must be lifted late in autumn and placed in a dry, cool cellar, covering the roots with soil.

Broad-Leaved Batavian (Escarolle). Leaves broad, light green, nearly plain. Pkt., 10c.; 20c. per oz.; ¼ lb., 50c.; \$1.50 per lb.

Giant Fringed (Oyster Endive). A variety with a large white heart and broad fringed leaves; heads measure 15 inches in diameter. Pkt., 10c.; 20c. per oz.; ¼ lb. 50c.; \$1.50 per lb.

Improved Green Curled. An improvement over the common green variety, producing a larger head and thicker leaves. 5c. per pkt.; large pkt., 10c.; 20c. per oz.; ¼ lb., 50c.; \$1.50 per lb.

White Curled (Self-blanching). This is the finest White Curled variety; always crisp and tender. Pkt., 10c.; 20c. per oz.; ¼ lb., 50c.; \$1.50 per lb.

GARLIC SETS

Ail (Fr.); Knoblauch (Ger.); Aglio (Ital.)

A hardy flavoring onion, used extensively in the French method of cooking. This variety should not be compared with the common field sort. 35c. per lb.; 5 lbs. for \$1.50.

HERBS. Complete list on page 36.

HOP VINE

Besides being used in culinary and medicinal ways, this makes a valuable shade plant. Hardy and rarely winter kills. The hops are gathered about September and stored for use on a dry floor, or hung in bags.

Green Variety, Pot-Grown Plants. 25c. each; doz., \$2.50; \$18.00 per 100.

HORSERADISH ROOTS (Ready in March)

Set the roots in rows 2½ feet apart, 1½ feet apart in the row. Late in the fall lift as many roots as you think you will use, cut off the top, place them in a cool cellar, covered with soil or sand; grate as wanted. A bed once planted remains for years.

Maliner Kren. A quick-growing variety and far superior to the common variety. Large cuttings, 35c. per doz.; per 100, \$2.00 (postpaid, \$2.10); \$15.00 per 1000.

ALL SEEDS OFFERED ON THIS PAGE MAILED POSTPAID AT PRICES QUOTED

KALE OR BORECOLE

Chou Vert (Fr.); Blatterkohl (Ger.); Cavolo Verde (Ital.)
 One ounce will sow a drill 150 ft. long; 3 lbs. will sow an acre.

For early use it may be sown in May; when desired for winter use, sow in September, broadcast or in rows 2 ft. apart. Cover for protection against severe freezing and snow. Do not handle while in a frozen condition. One of the finest nutritious greens for winter and early spring use.

Dwarf Green Curled. This variety is very dwarf and compact, rarely attaining a height of over 6 inches. The color is dark green; curly. Pkt., 10c.; 15c. per oz.; ¼ lb., 40c.; \$1.25 per lb.

Imperial Long Standing. The leaves are very crimp, dark green color. Stands quite tall, an excellent producer. It is just as hardy as any of the other sorts, and will be found very profitable where quantity as well as quality is desired. Pkt., 5c.; 10c. per large pkt.; oz., 15c.; 40c. per ¼ lb.; \$1.25 per lb.

Siberian. A very hardy variety, leaves large and cook very tender. Pkt., 10c.; 15c. per oz.; ¼ lb., 40c.; \$1.25 per lb.

KOHL-RABI

Chou Rave (Fr.); Kohl-Rabi (Ger.); Cavolo rapa (Ital.)
 One ounce will produce about 2500 plants.

It is regrettable that this splendid vegetable is not more widely used. We would suggest to those who have not given it a trial that they do so. Sow seed in early spring in hotbeds or outdoors and transplant when 3 inches high, in rows 18 inches apart, 6 inches in the row. The edible part is the root, which grows above the ground; this should be used when it attains a size of 2½ inches in diameter or less; at this stage it is extremely tender and delicious, while if allowed to get larger it is woody. Prepared and served like turnips, except that a few of the bottom leaves can be cooked with the root.

Blue or Purple Vienna. The flesh is white, skin, a bluish color. Principally used for outdoor sowing. Pkt., 10c.; 15c. per ½ oz.; oz., 30c.; 85c. per ¼ lb.; lb., \$2.50.

Early White Vienna. This variety is suited for sowing under glass and for outdoors. The top is very short, thus allowing all the development to go to the root, insuring early maturity. Very finely grained and of excellent quality. Pkt., 5c.; 10c. per large pkt.; ½ oz., 15c.; 25c. per oz.; ¼ lb., 75c.; \$2.25 per lb.

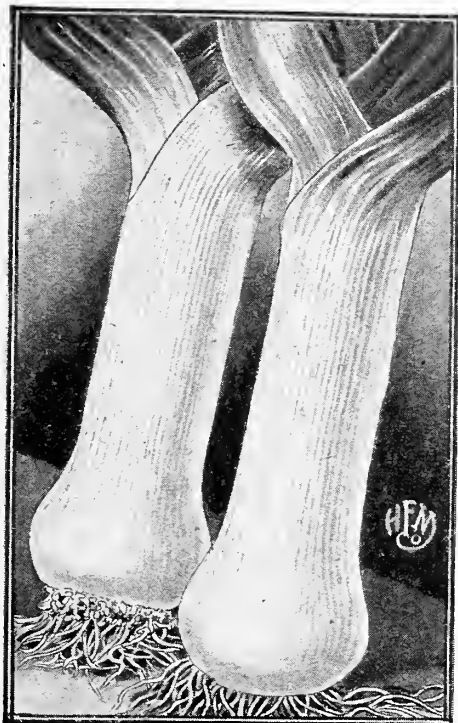

Giant Carentan Leek

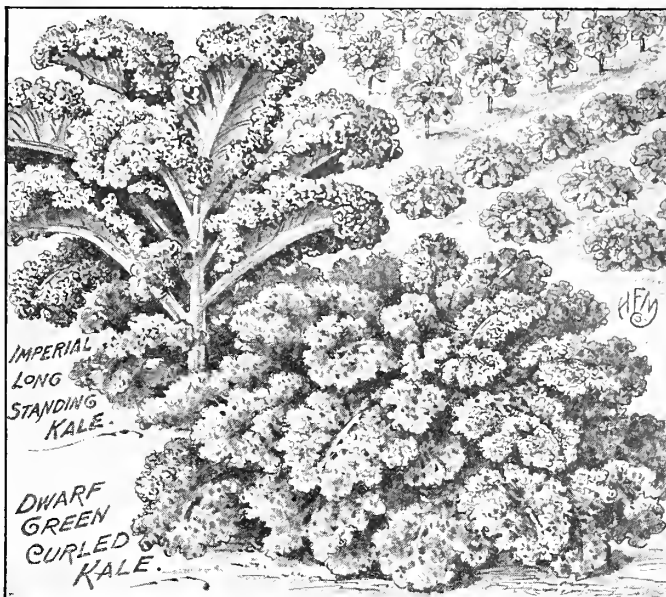

LEEK

Poireau (Fr.); Lauch (Ger.); Porro (Ital.)
 One ounce of seed will produce about 2500 plants.

Allied to the onion family but producing no bulb; the stalks are cut and used for flavoring soups; also they are boiled and served with melted butter, and make a very palatable dish on account of their mild flavor. Sow seeds in April in rows 1 foot apart, covering the seed about an inch; when about 4 inches high transplant where it is to develop, in rich soil in rows 18 inches apart, 6 inches in the row. When fully grown, hill soil against them to blanch them; about November 1st take up the plants and store them in a cool cellar, placing the root end in soil 3 or 4 inches, thus a supply may be had all winter.

Giant Carentan. A variety which produces colossal stalks of tender quality; splendid for exhibition purposes. 5c. per pkt.; large pkt., 10c.; 15c. per ½ oz.; oz., 25c.; 75c. per ¼ lb.; lb., \$2.50.

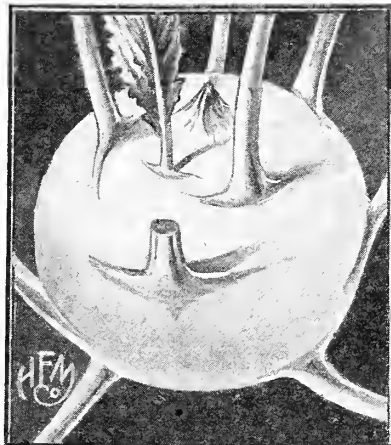

Kohl-Rabi

London Flag. Popular for the home garden. Makes a longer but narrower stalk than others. Pkt., 10c.; 15c. per ½ oz.; oz., 25c.; 75c. per ¼ lb.; lb., \$2.50.

MANGEL-WURZEL (See Page 25)

MARTYNIA (Unicorn Plant)

A bushy plant growing 2 feet in height, bearing clusters of pink flowers resembling gloxinias, which afterwards turn to long green pods, which when picked may be pickled the same as cucumbers, making a very tasty relish. Sow seeds in April outdoors and transplant so the plants stand 2 feet apart each way.

Proboscidea. Pkt., 10c.; 20c. per ½ oz.; oz., 35c.; \$1.25 per ¼ lb.

LAVENDER (HERB)

Seed. Pkt., 10c.; 25c. per ½ oz.; oz., 40c.

Lavender Plants. Each, 25c.; \$2.50 per doz.; per 100, \$18.00.

MINT (HERB)

Pkt., 25c.; 65c. for 3 pkts.

MINT PLANTS

Spearmint. 20c. each; doz., \$1.50; \$10.00 per 100.

Peppermint. 20c. each; doz., \$1.50; \$10.00 per 100.

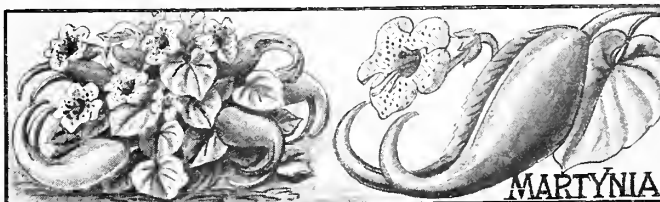

HEADING VARIETIES

Laitue (Fr.); Lattich Salat (Ger.); Lattuga (Ital.)

One ounce of seed will produce about 2500 plants.

All Heart. An excellent lettuce for either spring or summer use. The head, while large, has a loose heart, which is of a decided buttery flavor; can be used for sowing in frames, or in spring and early summer outdoors. Pkt., 10c.; 15c. per $\frac{1}{2}$ oz.; oz., 25c.; 60c. per $\frac{1}{4}$ lb.; lb., \$2.00.

All Right (Michell's). This is not a variety for forcing, but rather for an early spring crop in the hotbed or outdoors, and for sowing in August for late autumn under sash or outside; it is not affected by cold, which, with some sorts, turns them brown. On the other hand, this variety retains a rich green color. The heads are very large, often 12 inches in diameter, very solid and with a rich buttery heart of light yellow. Don't use this variety for a summer crop. Pkt., 10c.; 15c. per $\frac{1}{2}$ oz.; oz., 25c.; 60c. per $\frac{1}{4}$ lb.; lb., \$2.00.

Big Boston. A large, flat, cabbage-headed variety; splendid for midsummer or fall use, or under glass in the early spring and autumn; a delightful shade of light green, tinged light brown on the outer leaves. Pkt., 10c.; 15c. per $\frac{1}{2}$ oz.; oz., 25c.; 60c. per $\frac{1}{4}$ lb.; lb., \$2.00.

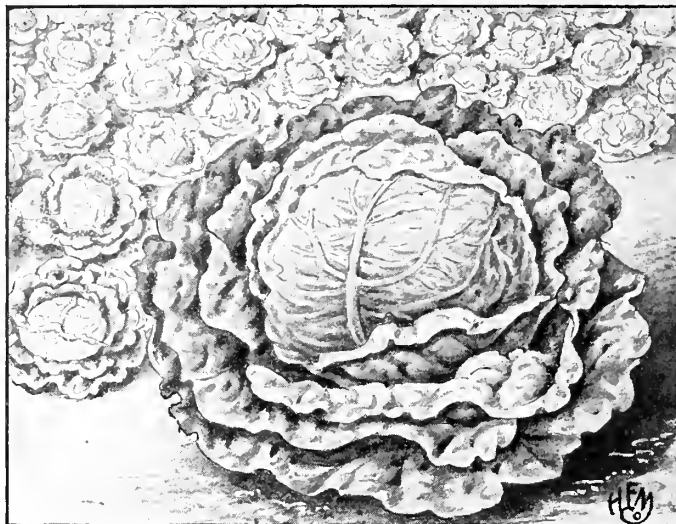

Michell's Number One Lettuce

Michell's Number One. This lettuce is a positive header under most trying conditions. It is tender, of a decided buttery flavor, and unusually large. A valuable type for hot weather; also desirable for autumn use. Should not be used for forcing. Pkt., 10c.; 15c. per $\frac{1}{2}$ oz.; oz., 25c.; 60c. per $\frac{1}{4}$ lb.; lb., \$2.00.

New York or Wonderful. Of the cabbage-headed sorts this is a leader; the color is dark green, with white interior; the heads are large, having curled outer leaves; popular kind for summer. Pkt., 10c.; 15c. per $\frac{1}{2}$ oz.; oz., 30c.; \$1.00 per $\frac{1}{4}$ lb.; lb., \$3.25.

Prize Head. A splendid loosely-formed head, claimed to do well where all others fail; desirable for outdoor planting only; has a dark tinge on the outer leaves. Pkt., 10c.; 15c. per $\frac{1}{2}$ oz.; oz., 25c.; 50c. per $\frac{1}{4}$ lb.; lb., \$2.00.

Salamander (Mammoth). One of the best midsummer varieties, resisting heat and drought, and remains in heading condition longer than many others. The heads are enormous, a fresh green color; loose leaves can all be used, as they are brittle and tender. Pkt., 10c.; 15c. per $\frac{1}{2}$ oz.; oz., 25c.; 60c. per $\frac{1}{4}$ lb.; lb., \$2.00.

Unrivalled. Very large, light green and of a crisp nature; very desirable for summer use. Pkt., 10c.; 15c. per $\frac{1}{2}$ oz.; oz., 30c.; 70c. per $\frac{1}{4}$ lb.; lb., \$2.50.

Wayahead. The earliest hard heading lettuce in cultivation, doing well either under glass or in the open, in spring or autumn. The heart is a golden buttery color, and of a delicious flavor. Pkt., 10c.; 15c. per $\frac{1}{2}$ oz.; oz., 25c.; 60c. per $\frac{1}{4}$ lb.; lb., \$2.00.



Prize Head Lettuce

Big Boston (Davey's Improved). (See illustration page 23.)

This strain is superior to the usual strain of Big Boston; heads larger, more solid and of better flavor; excellent for under glass or for midsummer or fall outdoors. Pkt., 10c.; 15c. per $\frac{1}{2}$ oz.; oz., 30c.; 70c. per $\frac{1}{4}$ lb.; lb., \$2.50.

Boston Market (White Seeded Tennisball). Early, small heading variety; one of the best for forcing; the heart is very solid and crisp. Pkt., 10c.; 15c. per $\frac{1}{2}$ oz.; oz., 25c.; 60c. per $\frac{1}{4}$ lb.; lb., \$2.00.

Dutch Butter (Private Stock). A medium-sized head; light green leaves, with delicate yellow heart. The outer leaves are tinged brown on the edges. Suitable for forcing or outdoor planting. Pkt., 10c.; 15c. per $\frac{1}{2}$ oz.; oz., 25c.; 60c. per $\frac{1}{4}$ lb.; lb., \$2.00.

Hanson Improved. Tremendous solid heads; the outer leaves are curled, the interior is almost white and very tender; stands the heat well, therefore excellent for summer use; this produces probably the heaviest head of lettuce of any variety. Pkt., 10c.; 15c. per $\frac{1}{2}$ oz.; oz., 25c.; 60c. per $\frac{1}{4}$ lb.; lb., \$2.00.

Iceberg. A splendid variety, producing large, solid heads; very firm, crisp and of fine flavor; leaves curly. Pkt., 10c.; 15c. per $\frac{1}{2}$ oz.; oz., 25c.; 60c. per $\frac{1}{4}$ lb.; lb., \$2.00.

May King. The first solid head lettuce to mature outdoors, hence its name; it is of good size, with tender, full heart. Suitable for sowing under sash in early spring. 5c. per pkt.; large pkt., 10c.; 15c. per $\frac{1}{2}$ oz.; oz., 25c.; 60c. per $\frac{1}{4}$ lb.; lb., \$2.00.

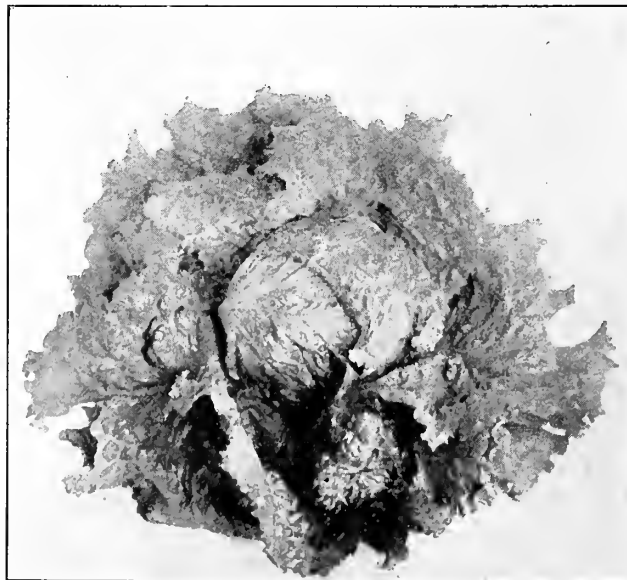

New York or Wonderful Lettuce

ALL SEEDS on this page mailed postpaid at prices quoted

LOOSE LEAF OR CUTTING VARIETIES

For early or midsummer use seed should be sown very thickly. When pulling the young plants try to do so with an effort to thin out the bed, thus allowing the remaining plants to become large. This class of lettuce is always tender.

Black Seeded Simpson. Ideal for midsummer use, as it withstands the most trying conditions of heat and drought. When matured, presents a formidable loose head with finely fringed leaves. Pkt., 10c.; 15c. per ½ oz.; oz., 25c.; 60c. per ¼ lb.; lb., \$2.00.

Early Curled Simpson. A splendid curly-leaved sort; loose heads and very tender. Pkt. 10c.; 15c. per ½ oz.; oz. 25c.; 60c. per ¼ lb.; lb. \$2.00.

Grand Rapids (Special Strain). The leading variety in this class for forcing under glass, but it may also be grown successfully outdoors. The leaves are very curly, crisp and brittle, and have a palatable flavor. 5c. per pkt.; large pkt., 10c.; 15c. per ½ oz.; oz., 25c.; 60c. per ¼ lb.; lb., \$2.00.

Silesian. This variety should be cut instead of pulled, as it makes new growth from the same root. A light green color, and when given plenty of room will form a large loose head. Pkt., 10c.; 15c. per ½ oz.; oz., 25c.; 60c. per ¼ lb.; lb., \$2.00.

COS, ROMAINE OR CELERY LETTUCE

Of French origin, this type, as will be seen by the illustration, differs greatly from the American varieties by its peculiar upright growth; it has a decided flavor. To have it tender the heads must be tied together at the top so that the inner leaves blanch. It is best adapted to outdoor planting and stands the heat well.

Kingsholm Cos. The largest and best heading variety of this type. The inner leaves blanch almost pure white and have little or no rib, the heads are very full throughout and therefore contain more edible part. 5c. per pkt.; large pkt., 10c.; 15c. per ½ oz.; oz., 25c.; 60c. per ¼ lb.; lb., \$2.00.

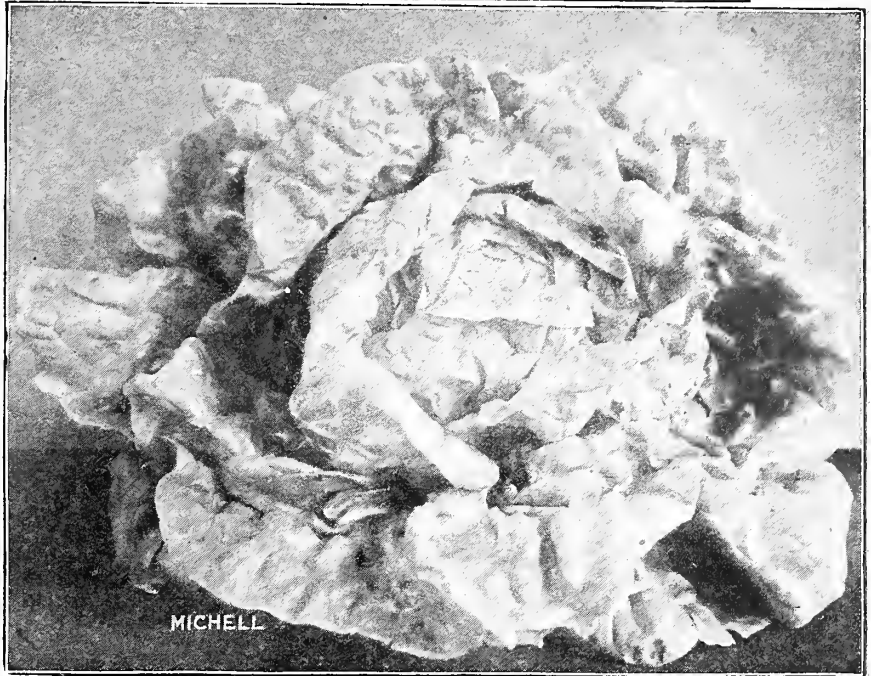

Lettuce—Davy's Improved Big Boston

LETTUCE PLANTS

We can supply these (at all seasons) in heading varieties only, of our selection. 25 for 20c.; 75c. per 100 (postpaid, 85c.); per 1000, \$6.00.

LETTUCE GARNISHINGS

Chervil. One of the most delicious flavoring plants in cultivation. The leaves are finely cut and mixed with the lettuce, or distributed as gathered, on top. 5c. per pkt.; large pkt., 10c.; 15c. per ½ oz.; oz., 25c.; 75c. per ¼ lb.; lb., \$2.00.

Chives. These possess a delicate onion flavor; adds a piquancy without being objectionable like onion. The top is cut off the plant (not too close) and chopped finely and added in small quantities to the dish of salad. Strong plants, 15c. each; doz., \$1.50; \$10.00 per 100.

Tarragon (Estragon). Perfectly hardy, and once established remains for years; the foliage is finely cut and spread over the lettuce. It is also put into vinegar, to which it imparts a flavor. Plants, 30c. each; doz., \$2.50; \$18.00 per 100.



Lettuce—Kingsholm Cos

Testimonial

Luzerne, Pa.

I received my former order in good condition, and enclose you herewith another one. Michell's seeds are the best I ever used.

R. K.

Testimonial

Bexely, Ohio.

I am very glad to report to you concerning my success in every way with seeds purchased from you. My garden was a delightful success.

J. H. H.

Testimonial

Brooklyn, N. Y.

My order was received in such fine condition that I will always remember Michell's Seed House for my future orders.

O. E.

MICHELL'S MUSKMELON OR CANTALOUPE.

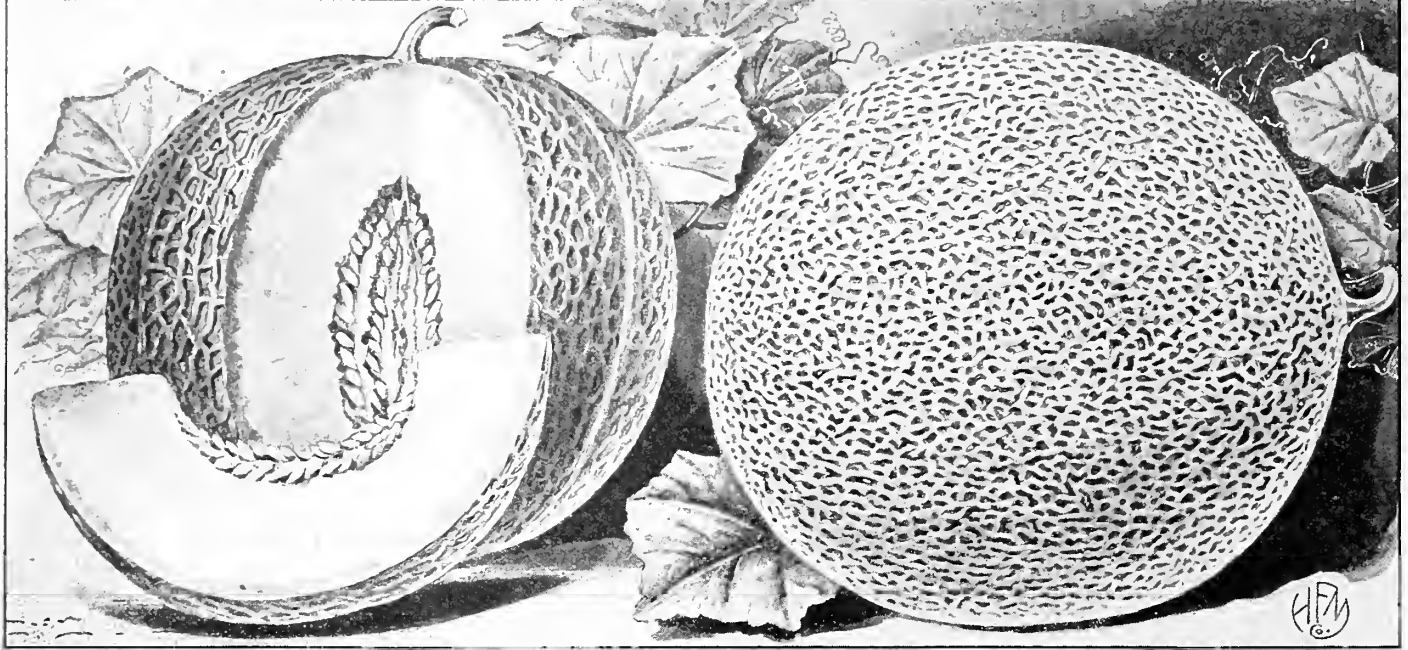

Rockyford

Delicious Gold-Lined

Melon Muscade (Fr.); Melone (Ger.); Popone Melone (Ital.)

One ounce will plant about 50 hills; 2 to 3 lbs. are required for an acre.

All seeds on this page mailed postpaid at prices quoted.

While these do best to reach their greatest perfection in a light sandy loam, any good well-prepared garden soil suits them. Plant when the ground has become permanently warm in hills 6 feet apart each way, 8 to 10 seeds in a hill. After the second tier of leaves have formed, thin out to 4 plants in a hill. Watch carefully for insects of various kinds, especially the melon louse that works under the leaf and shrivels it, causing the plant to die. To fight this successfully, raise up the vines and spray underneath with Pyrox, Arsenate of Lead, or some of the various Nikoteen preparations. When the vines have made a good start, they are not bothered with insects thereafter.

Delicious Gold Lined. Flesh thick, fine-grained and sweet; color green, with a gold margin next to the seed cavity; slightly oval and heavily netted. A variety which every melon planter should not overlook to include in his list. Pkt., 10c.; 15c. per $\frac{1}{2}$ oz.; oz., 25c.; 75c. per $\frac{1}{4}$ lb.; lb., \$2.25.

Emerald Gem. Among the standard varieties, this has long been a leader. The flesh, which is thicker than any other melon of the same shape, is a rich salmon shade and ripens extremely close to the rind. It is exceedingly sweet and one of the melons when you eat once of you remember for a long while. Pkt., 10c.; 20c. per oz.; $\frac{1}{4}$ lb., 60c.; \$2.00 per lb.

Fordhook. This is claimed to be one of the best melons ever introduced. Of flat shape like Emerald Gem, on which it is claimed to be an improvement. The flesh is a beautiful salmon orange, surprisingly sweet. The fruits are very large, often weighing 2 lbs. each; an early variety, and always prolific. The netted rind is very thin and the melon can be eaten very close thereto. Pkt., 10c.; 20c. per oz.; $\frac{1}{4}$ lb., 60c.; \$2.00 per lb.

Honey Dew. A late maturer, it might easily be termed a family melon because one is large enough for a number of people. It is large in size, being 6 inches in diameter and from 7 to 8 inches long. The skin is smooth with an occasional net, and creamy white. The thick flesh is emerald green, melting, and of a wonderfully delicious flavor, sweet as honey. The ripe melons can be kept in a suitable place for several weeks before using. In fact, they can be placed in cool storage and kept until Christmas. Pkt., 10c.; 15c. per $\frac{1}{2}$ oz.; oz., 25c.; 75c. per $\frac{1}{4}$ lb.; lb., \$2.00.

Jenny Lind. A small, flat, very early sort; heavily netted and ribbed; green flesh; an altogether good variety to plant with others, using this for the first picking. 5c. per pkt.; large pkt., 10c.; 15c. per $\frac{1}{2}$ oz.; oz., 25c.; 60c. per $\frac{1}{4}$ lb.; lb., \$2.00.

Mitchell's Delicious. This deservedly enjoys a good name, it is one of the very large, irregular pumpkin-shaped melons, with a smooth, silver-gray rind. The flesh is very deep orange-salmon. Pkt., 20c.; 60c. per $\frac{1}{2}$ oz.; \$1.00 per oz.; per $\frac{1}{4}$ lb., \$3.00.

Rockyford (Improved Strain). The outside is a light green, changing to a grayish color; well netted. It is mostly all meat, with a very small seed cavity, and often weighs a pound and one-half to the fruit. Fine for market or the home garden. Pkt., 10c.; 20c. per oz.; $\frac{1}{4}$ lb., 50c.; \$1.75 per lb.

FORCING MELONS (English Varieties)

Forcing melons can be grown successfully outside in hotbeds. Sow seed in pots in March and transplant to hotbed when three leaves have developed; these will ripen fruit in June and July. For indoor use treat same as forcing cucumbers.

Blenheim Orange, Invincible-Scarlet, Windsor Castle.

Each variety per pkt., 30c.

Sutton's A1. In original packets, \$1.25 per pkt.

MELON NETS. For supporting forcing melons in greenhouses; made very strong; will last for a number of crops. \$2.25 per doz.; per 100, \$17.00.

MUSTARD

One ounce will sow a row 75 feet long. It makes a delicious green salad, pungent in taste, highly palatable and healthy. Sow every two weeks in rows the same as spinach. It must be used while young, as only then is it tender and mild. Fine winter greens if sown in a heated frame or greenhouse, also fine if served with lettuce for flavoring. The seed can be harvested if the plant is allowed to stand and used for other culinary purposes.

Southern Giant Curled.

The best of the curled mustards; of sweet flavor; matures very early and produces abundant foliage. Pkt., 10c.; 15c. per oz.; $\frac{1}{4}$ lb., 40c.; \$1.00 per lb.

White or Yellow. Pkt., 5c.; 10c. per large pkt.; oz., 15c.; 35c. per $\frac{1}{4}$ lb.; lb., 85c.



Mustard, Southern Giant Curled

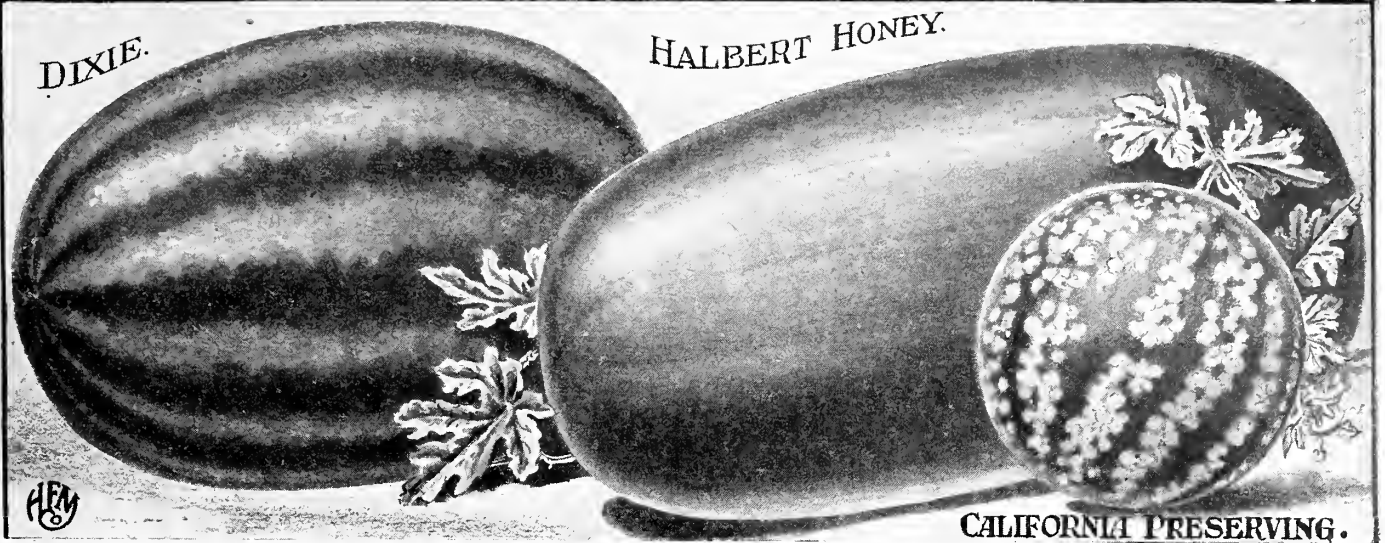

CALIFORNIA PRESERVING.

Melon d'eau (Fr.); Wasser Melone (Ger.); Melone d'aqua (Ital.)

One ounce will plant thirty hills, four pounds for an acre.

Plant in hills 10 feet apart each way or in drills 10 feet apart, dropping one seed every 3 feet. A little land plaster dusted over the young plants will keep beetles away. Watermelons require planting after the soil has become thoroughly warm, say about May 10th in the latitude of Philadelphia. Our list of watermelons is limited, as we offer only the varieties which from experience we know are the better ones. **Note.**—Watermelon seed sent post-paid at prices quoted.

Dixie. The name attaches to this variety a peculiar recollection of things truly Southern, where this melon is at home. 'Tis one of the old-time favorites, roundish-long in shape. The skin is dark green, mottled light; the flesh is very sweet and ripens close to the rind. 5c. per pkt.; large pkt., 10c.; 15c. per oz.; ¼ lb., 40c.; \$1.25 per lb.

Halbert Honey. An ideal family garden, or home market melon. The long fruits with blunt ends are very large and weigh often 50 lbs.; the rind is very thin, dark green, while the flesh is a rich crimson. It tastes like a sugar stick and it melts under pressure of the tongue. It is very prolific and is altogether a first-rater. Pkt., 10c.; 15c. per oz.; ¼ lb., 40c.; \$1.25 per lb.

Kleckley Sweets. A sweet one, to be sure, with a luscious tenderness all its own. It is not a shipping variety, as the rind is too close to the ripe, fluffy, rich red meat, when in condition to use. The melons average about 20 inches long and ripen quite early. Our strain is grown from the originator's seed stock and we can recommend it highly. Pkt., 10c.; 15c. per oz.; ¼ lb., 40c.; \$1.25 per lb.

Tom Watson. A very handsome large fruit, frequently 2 feet long and 12 inches in diameter. The dark green rind is a contrast to the bright scarlet flesh, which is of splendid texture and flavor; the sugary meat really melts in your mouth. Nothing can touch it in the melon line for shipping qualities. The rind being tough, it will resist plenty of abuse. Pkt., 10c.; 15c. per oz.; ¼ lb., 40c.; \$1.25 per lb.

PRESERVING MELON OR CITRON

A large-fruited variety; pure white flesh and thin rind. This is expensive when bought, yet can be grown and preserved by any energetic housewife, who will then also know it to be absolutely pure and good. It is planted like watermelon.

California Red Seeded. Pkt., 5c.; 10c. per large pkt.; oz., 15c.; 40c. per ¼ lb.; lb., \$1.25.

MANGEL-WURZEL OR CATTLE BEETS

Seed selected from specimen roots.

Sow 5 lbs. per acre in April and May in thoroughly plowed, well-manured soil, in drills about 24 inches apart. Thin out to 12 inches apart in the row, and keep the weeds down by frequent hoeing and cultivating. Low ground is best adapted for Mangel-Wurzels. They provide excellent winter food for cattle, sheep, hogs and poultry.

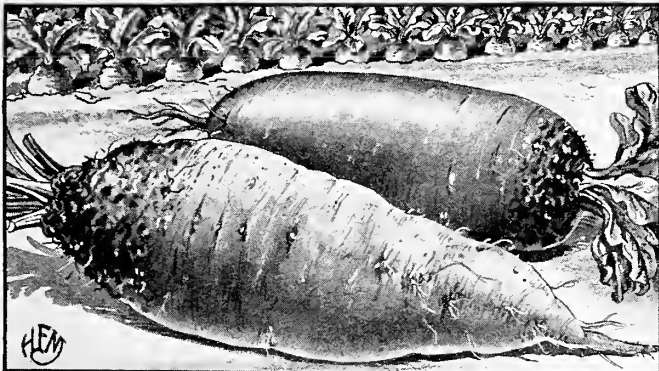

Michell's Mammoth Long Red and Golden Tankard Mangels

Golden Tankard. The best long yellow mangel in cultivation. Relished by cows, sheep and hogs. Matures earlier than other large sorts. 10c. per oz.; ¼ lb., 25c.; 75c. per lb.; 5 lbs., \$3.25.

Lane's Improved White Sugar. This variety attains an enormous size, growing considerably above the ground; one of the best for stock feeding. 10c. per oz.; ¼ lb., 25c.; 75c. per lb.; 5 lbs., \$3.25.

Mammoth Long Red. This is an enormously productive variety, yielding from 50 to 75 tons to the acre, a single root often weighing from 20 to 40 pounds. It is the best long red mangel. 10c. per oz.; ¼ lb., 25c.; 75c. per lb.; 5 lbs., \$3.25.

Red Globe. An excellent sort; very prolific; good for late planting. 10c. per oz.; ¼ lb., 25c.; 75c. per lb.; 5 lbs., \$3.25.

Note.—If Mangel-Wurzel is desired by parcel post, please allow for mailing as per parcel post table on page 1.

ALL SEEDS offered on this page mailed at quoted prices except Mangel-Wurzel.

MICHELL'S PRACTICAL GARDEN POINTERS
Is the title of a publication we have compiled that contains a mine of information on things horticultural and agricultural. There is a free copy for you.

See page 12 for Table Beets

MICHELL'S VEGETABLE SEEDS, ETC.

Prices of all seeds quoted on this page (except Mushroom Spawn and Onion Sets) postpaid.

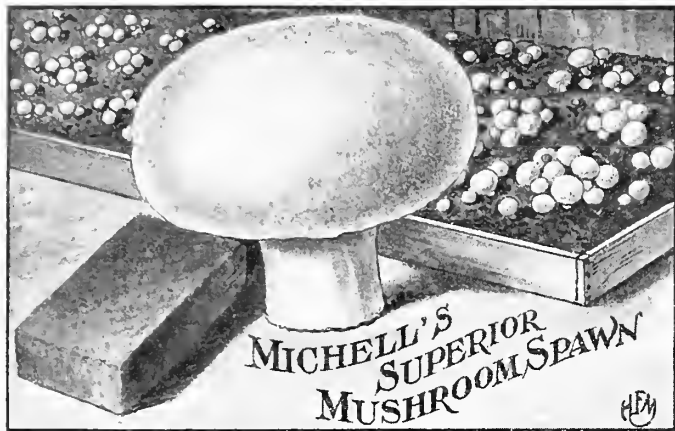

MICHELL'S PURE CULTURE BRICK SPAWN

If wanted by mail, allow for postage at rate of 10c. per brick.

Mushrooms are within the reach of anyone who has a greenhouse or a cellar. A crop is produced with good spawn, and a little care and patience in about 4 to 6 weeks, and continues bearing about two months. New beds can be started at intervals which will give a supply the entire season. The first planting can be made in July, the last in March. Summer spawned beds do not bear well. Ask for our Free Booklet on Mushroom Culture, which also describes, further, these different spawns. 1 Brick will spawn 8 to 10 sq. ft.

Direct No. 8. Cream White. For use from April to October.
Direct No. 9. Pure White. For use from October to April.
 Per Brick \$0.35 | Per 10 Bricks \$2.75
 Per 5 Bricks 1.50 | Per 25 Bricks 6.50
 Per 50 Bricks \$12.50

See page 6 for Pure Culture Spawn in carton form.

BOOKS ON GROWING MUSHROOMS

Pamphlet (Gratis for a postal card asking for it).
Mushroom Culture (Duggar) \$2.00
Mushrooms, How to Grow (Falconer) 1.60



MUSHROOM OR HOTBED THERMOMETERS

Heavy Galvanized Iron Point \$2.00
 Brass Point Wood Case Paper Scale 1.50

Thermometers should, wherever possible, be sent by express. We do not guarantee safe arrival if forwarded by parcel post.

TESTIMONIAL

Gentlemen: Punxsutawney, Pa.
 Last fall I purchased spawn from you and I want to tell you it is wonderful the way the mushrooms grew. I planted a bed about 5 by 9 feet and the bed was a solid mass of mushrooms.
 Yours truly, E. J. B.

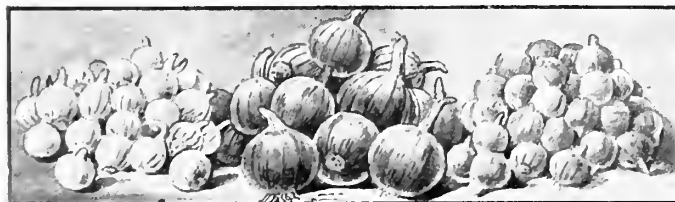

We make a specialty of Choice Onion Sets.

OKRA OR GUMBO

Combo (Fr.); Ocher (Ger.); Ocra (Ital.)
 One oz. will plant a row about 100 feet long; 2 lbs. required for 3000-foot row.

The seed is sown in rows, thickly, like peas (in ground that is rich), after the frost and cold have disappeared, the rows, 3 feet apart; when about 6 inches high the plants should be thinned out to stand 6 inches apart in the row. The pod is used when young and tender, sliced in soups and stews; what is not utilized during the summer may be harvested, cut in slices and dried in the sun; after being cured in this way it should be put on the pantry shelf for use during the winter. In this way one may have Chicken Gumbo soup any day of the year.

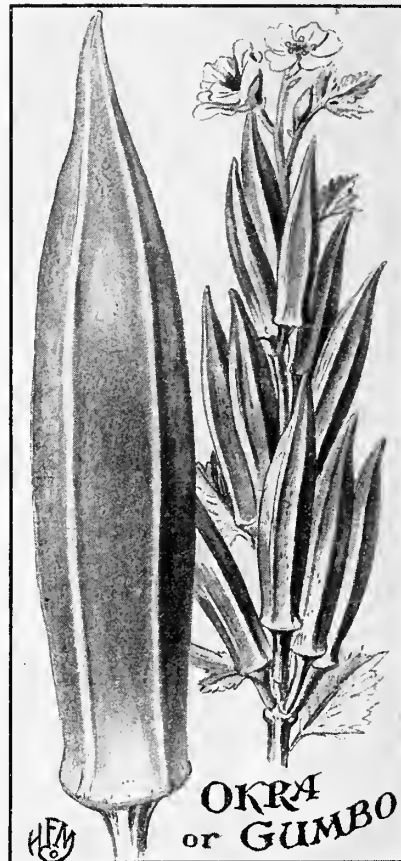

Perkins' Long Pod (Improved Strain). A wonderful dwarf type, setting pods when the plants are only a foot high. It can be planted somewhat earlier than other sorts. The pods are exceedingly long and tender and of a dark green color. 5c. per pkt.; large pkt., 10c.; 15c. per oz.; 1/4 lb., 25c.; 75c. per lb.

White Velvet or Creole. The pods of this variety are very free from ridges, being almost perfectly smooth; they are tender and very light green, almost white in color. Pkt., 10c.; 15c. per oz.; 1/4 lb., 25c.; 75c. per lb.

ONION SETS

One quart will plant a row about 50 feet. Plant just as soon as the ground can be worked. Press the bulb in the ground lightly (and do not cover), in rows 12 inches apart, 2 inches apart in the row; so that all the development goes in the onion, on signs of their going to seed, bend the top over but do not break it off. They can be harvested in the locality of Philadelphia for winter storage as early as July 10th. The advantage in planting onion sets lies in the fact that the young onion is ready often in 5 weeks from the time of planting, while those grown from seed cannot be used until well in the autumn.

Shipped on Local Orders about March 10, unless otherwise requested.

If wanted by mail, add 5c. per pint or 10c. per qt. for postage.

	Pt.	Qt.	2 qts.	4 qts.
Yellow	\$.13	\$.25	\$.45	\$.80
White	.15	.30	.55	1.00
Red	.15	.30	.55	1.00
		Lb.	5 lbs.	10 lbs.
White Multiplier		\$.30	\$1.40	\$2.60
Potato Onions		.30	1.40	2.60
Shallots		.30	1.40	2.60

Tree or Top Onions. Can be supplied in September and October.
 Garlic Sets. Per lb., 30c.; \$1.25 per 5 lbs.
 We give 32 lbs. per bushel on Onion Sets.

Prices on larger quantities of Onion Sets will be quoted on request.

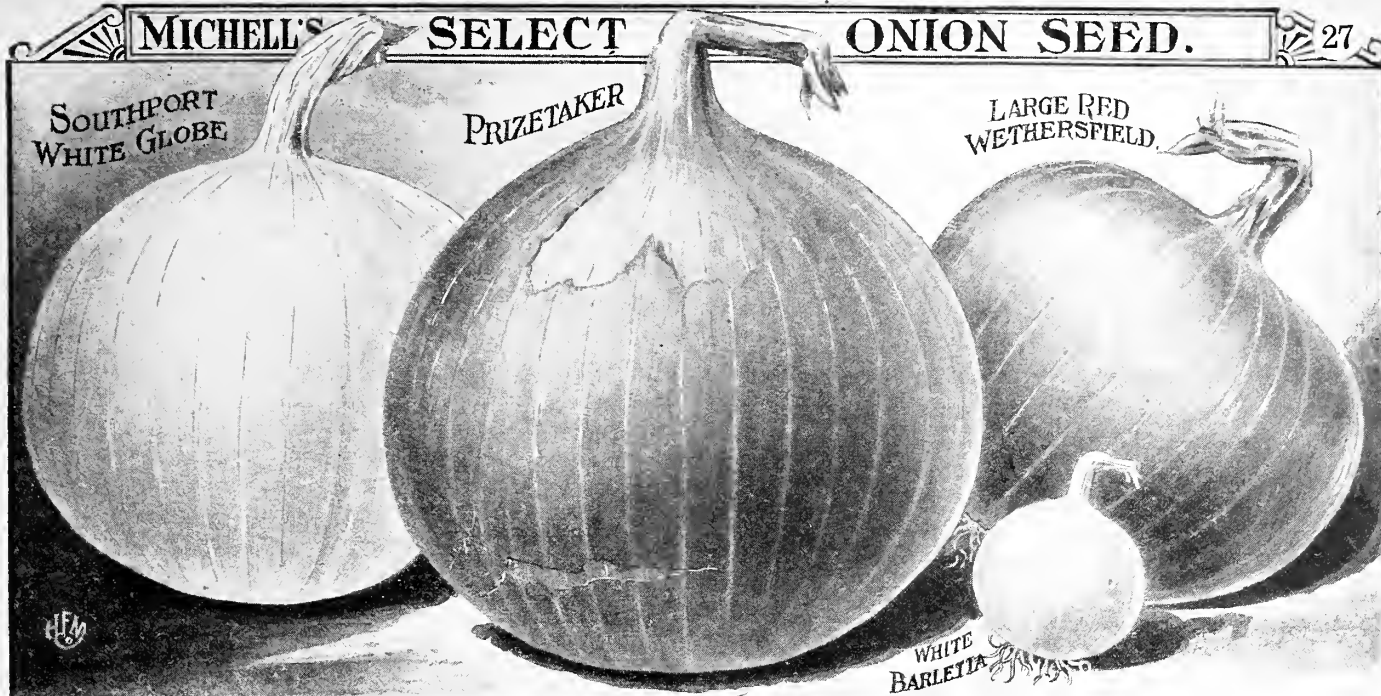

Ognon (Fr.); Zwiebel (Ger.); Cipolla (Ital.)

To grow full size onions, one ounce of seed will sow a 100-foot row; 5 to 6 pounds are required per acre. If it is desired to grow onion sets, sow 25 to 30 pounds per acre.

Sow in the early spring in rows 2 feet or less apart, according to cultivation method employed. The seed should be firmed in the soil. If it is desired to grow full size onions the first year, thin out when 3 inches high, so that they stand about 2 or 3 inches apart. White onions are mildest in flavor and are recommended for early use. The yellow sorts are best for winter keeping.

Ailsa Craig. The largest of all onions, often weighing three lbs. and over, each. In England it is the foremost variety and will be seen there on exhibition during all vegetable shows. It is globe-shaped, slightly pointed at top and base; the color is a beautiful straw yellow. To obtain best results sow seed in the hotbed and later transplant where they are to grow; in planting place 4 to 6 inches apart and thus procure gigantic specimens. Pkt., 10c.; 20c. per 1/2 oz.; oz., 35c.; \$1.35 per 1/4 lb.; lb., \$4.25.

Bermuda White. An early variety, with immense flat partially globe-shaped bulb, producing (when transplanted about 4 inches apart) gigantic onions the first season. In the raw state it is very mild, while, when cooked, the flesh is tender and of a delicious flavor. For slicing it is one of the best. Pkt., 10c.; 25c. per 1/2 oz.; oz., 45c.; \$1.50 per 1/4 lb.; lb., \$5.00.

Danvers Yellow Globe. This almost round-shaped onion is extensively sown by the private and market gardener on account of its good keeping qualities. It is a dark straw color and always produces a good crop, growing to a large size. 5c. per pkt.; large pkt., 10c.; 15c. per 1/2 oz.; oz., 25c.; 70c. per 1/4 lb.; lb., \$2.50.

Large Red Wethersfield. A flat, large growing variety. The red onions are excellent winter keepers; flavor much like the yellow sorts; full-size onions can be grown in one season. Pkt., 10c.; 15c. per 1/2 oz.; oz., 30c.; \$1.00 per 1/4 lb.; lb., \$3.25.

Prizetaker. A mammoth yellow variety; if sown thinly it produces full-size onions in one season from seed, rivaling with the Bermuda varieties for size and flavor, often weighing 3 lbs. or more each. Pkt., 10c.; 15c. per 1/2 oz.; oz., 30c.; \$1.00 per 1/4 lb.; lb., \$3.25.

Southport Yellow Globe. Similar to the Danvers except larger in size, more like the Prizetaker. This is probably one of the most uniform growing varieties, every bulb being almost perfectly round and of the same size; light straw colored skin. Pkt., 10c.; 15c. per 1/2 oz.; oz., 30c.; 90c. per 1/4 lb.; lb., \$3.25.

Southport White Globe. A beautiful type of an almost round onion, growing to an enormous size. This is perhaps the best onion of all for family use. The flesh when cooked is of a rich milky color, of tender and delicious flavor, and in the raw state it is one of the mildest. Pkt., 10c.; 20c. per 1/2 oz.; oz., 35c.; \$1.25 per 1/4 lb.; lb., \$4.50.

White Barletta. Extra early small round variety, used principally for pickling. Pkt., 10c.; 20c. per 1/2 oz.; oz., 35c.; \$1.15 per 1/4 lb.; lb., \$4.00.

Winter Keeper. A new round-shaped yellow variety of good size; a wonderful keeper, lasting well into the summer. For home garden or market purposes it should prove to be a winner. Pkt., 10c.; 15c. per 1/2 oz.; oz., 30c.; \$1.00 per 1/4 lb.; lb., \$3.00.

White or Silver Skin. The standard white onion for market or home use; it is of very mild flavor; semi-globe shaped and very uniform in growth and size. Pkt., 5c.; 10c. per large pkt.; 1/2 oz., 20c.; 35c. per oz.; 1/4 lb., \$1.25; \$4.50 per lb.

Yellow Strasburg or Dutch. A dark straw color skinned sort; almost flat in shape, but a large onion. Its fine keeping qualities is what recommends itself to the home, as well as the market gardener. For a yellow sort it is rather mildly flavored; for growing sets, more of this variety is sold than any other. One of the best winter keepers. Pkt., 10c.; 15c. per 1/2 oz.; oz., 25c.; 70c. per 1/4 lb.; lb., \$2.50.



We make a specialty of Choice Onion Sets (see Page 26).

ONION CULTURE. A good book by a Practical Grower, 90c. per copy.

BOOKS ON GARDENING AND FARMING, ETC.

The pleasures of gardening are materially increased with the aid of a good book on the subject. On page 192 of this catalog is offered a comprehensive list of them, which cover almost every phase of gardening. Add a few copies to your library.

All seeds offered on this page sent postpaid at quoted prices.

MICHELL'S CHOICE GARDEN PEAS



DANDY
EXTRAORDINARY

NOTES
EXCELSTOR

Dwarf
Champion

POTLATCH

GRADUS



Pois (Fr.); Erbsen (Ger.); Pisello (Ital.)

2 lbs. will plant 100 ft. of row; 90 to 120 lbs. per acre.

The smooth-seeded varieties may be sown as soon as the ground can be worked; the wrinkled sorts when the ground has become warmer. The distance apart for planting depends somewhat on the variety. To have a continuous crop, sow weekly up to June 15th, and a final planting again about August 15th. For the last planting use the dwarf early varieties.

EXTRA EARLY VARIETIES

Alaska. Smooth seeded; very early; height 2½ feet. Pkt., 10c.; 30c. per lb.; 2 lbs., 55c.; \$1.30 for 5 lbs.; 10 lbs., \$2.50; \$5.25 for 25 lbs.

Ameer. This is referred to sometimes as "Large Podded Alaska," on which it is a distinct improvement; smooth seeded; very early; height about 2½ ft. Pkt., 10c.; 30c. per lb.; 2 lbs., 55c.; \$1.30 for 5 lbs.; 10 lbs., \$2.50; \$5.75 for 25 lbs.

Dandy Extra Early. A selection of the Eureka, but far superior; smooth seeded; very prolific and desirable for the kitchen and market garden; height 24 inches. Pkt., 10c.; 15c. per ½ lb.; lb., 30c.; 55c. for 2 lbs.; 5 lbs., \$1.30; \$2.35 for 10 lbs.; 25 lbs., \$5.25.

Early June. A green seeded, smooth pea, desirable for first planting; height, 2½ feet. Pkt., 10c.; 30c. per lb.; 2 lbs., 55c.; \$1.30 per 5 lbs.; 10 lbs., \$2.50; \$5.25 per 25 lbs.

Early Morn. One of the earliest wrinkled peas. Pods large and well filled; very prolific; height 3 feet. Pkt., 10c.; 40c. per lb.; 2 lbs., 70c.; \$1.60 per 5 lbs.; 10 lbs., \$3.00; \$6.50 per 25 lbs.

Early 8 Weeks. A wrinkled variety, growing 12 to 15 inches high; a heavy cropper and especially desirable where room is scarce. Pkt., 10c.; per lb., 35c.; 65c. for 2 lbs.; 5 lbs., \$1.60; \$3.00 for 10 lbs.; 25 lbs., \$7.00.

Gradus or Prosperity. Never was there a pea offered which is so largely demanded as this very early sort. It is exceedingly luscious, wrinkled and a producer of gigantic pods and peas; height, 36 inches. Pkt., 10c.; 35c. per lb.; 2 lbs., 60c.; \$1.40 for 5 lbs.; 10 lbs., \$2.70; \$6.25 for 25 lbs.

Laxtonian. An extra fine early, dwarf sort; pods are large and well filled with peas of extra fine quality; height 18 inches. Pkt., 10c.; per lb., 35c.; 65c. for 2 lbs.; 5 lbs., \$1.50; \$2.75 for 10 lbs.; 25 lbs., \$6.25.

Little Marvel. Wrinkled; dwarf, 18 to 20 inches; prolific and sweet. Pkt., 10c.; 40c. per lb.; 2 lbs., 70c.; \$1.60 per 5 lbs.; 10 lbs., \$3.00; \$6.50 per 25 lbs.

Micell's Special Ex. Early. Of the smooth seeded sorts this is the peer. Extremely early, lusciously sweet and very tender; a grand yielder; height, 24 inches. Pkt., 10c.; 30c. per lb.; 2 lbs., 55c. \$1.30 for 5 lbs.; 10 lbs., \$2.50; \$5.25 for 25 lbs.

Nott's Excelsior (Improved Strain). A splendid early wrinkled pea, producing heavy crops of full pods very early. Height, 15 inches. Pkt., 10c.; 35c. per lb.; 2 lbs., 60c.; \$1.40 for 5 lbs.; 10 lbs., \$2.70; \$6.00 for 25 lbs.

Sutton's Excelsior. This wrinkled variety is quite hardy and can be planted earlier than most other wrinkled sorts; very early. It grows about 16 inches high, and makes a long, broad pod, well filled. Pkt., 10c.; 35c. per lb.; 2 lbs., 60c.; \$1.30 for 5 lbs.; 10 lbs., \$2.50; \$5.50 for 25 lbs.

The Pilot or Leader. The earliest of round-seeded varieties. The pods and peas are nearly as large as those of Gradus. It can be planted, of course, much earlier. The vines are of vigorous growth, 3 feet high, and produce an abundance of pods. The peas are of finest flavor. Pkt., 10c.; 35c. per lb.; 2 lbs., 60c.; \$1.40 per 5 lbs.; 10 lbs., \$2.70; \$6.00 per 25 lbs.

Thos. Laxton. Heavy producer; wrinkled, exceedingly early. Pods are large and filled with large peas of excellent flavor. Its heavy cropping qualities make it suitable for an early crop in the private garden; height, 36 inches. Pkt., 10c.; 35c. per lb.; 2 lbs., 65c.; \$1.50 per 5 lbs.; 10 lbs., \$2.75; \$6.00 per 25 lbs.

SECOND EARLY VARIETIES

Bliss Abundance. Produces very large pods containing six and even more peas of a delicious flavor; a great yielder; wrinkled; height, 20 inches. Pkt., 10c.; 30c. per lb.; 2 lbs., 55c.; \$1.30 per 5 lbs.; 10 lbs., \$2.50; \$5.25 per 25 lbs.

Daisy or Dwarf Telephone. One of the best medium early sorts, bearing large pods in the greatest abundance; wrinkled and very sweet; height, 18 inches. Pkt., 10c.; 35c. per lb.; 2 lbs., 65c.; \$1.50 per 5 lbs.; 10 lbs., \$2.90; \$6.00 per 25 lbs.

Potlatch. A wrinkled variety, similar to Daisy; sweet; pods well filled with peas; height 18 inches. Pkt., 10c.; 30c. per lb.; 2 lbs., 55c.; \$1.30 per 5 lbs.; 10 lbs., \$2.50; \$6.00 per 25 lbs.

Yankee Prince. A large podded wrinkled sort; heavy yielder; pods often measure 6 inches in length, and well filled with large peas of delicious flavor; height 4 feet. Pkt., 10c.; 35c. per lb.; 2 lbs., 65c.; \$1.50 for 5 lbs.; 10 lbs., \$2.75; \$6.25 for 25 lbs.

NOTE.—If Peas are wanted by parcel post, please allow for mailing, as per parcel post table on page 1.

GENERAL OR LATER CROP VARIETIES

Champion of England. A very tall, rank grower, but a wonderful yielder of delicious quality peas; seed wrinkled; height, 5 feet. Many of the old-time gardeners still cling to this as their favorite. Pkt., 10c.; 35c. per lb.; 2 lbs., 60c.; \$1.40 per 5 lbs.; 10 lbs., \$2.50; \$5.75 per 25 lbs.

***Dwarf Champion.** Possesses most all the good qualities of the famous Champion of England, and has the further advantage of being dwarf; a very delicious pea which should be planted extensively; height, 2 feet. Pkt., 10c.; 20c. per ½ lb.; lb., 35c.; 60c. per 2 lbs.; 5 lbs., \$1.40; \$2.60 per 10 lbs.; 25 lbs., \$6.00.

Long Island Mammoth. A very large podded semi-wrinkled variety; a great favorite with the market gardener; heavy yielder; height about 2½ feet. Pkt., 10c.; 30c. per lb.; 2 lbs., 55c.; \$1.35 for 5 lbs.; 10 lbs., \$2.60; \$6.00 for 25 lbs.

Telephone (Tall). The finest late wrinkled pea grown; exceedingly sweet; an abundant producer; height, 3½ feet. Pkt., 10c.; 35c. per lb.; 2 lbs., 65c.; \$1.50 for 5 lbs.; 10 lbs., \$2.75; \$6.00 for 25 lbs.

SUGAR OR EDIBLE POD PEAS

This type produces large, well-filled pods. They are cooked with the peas intact; very tender and exceedingly sweet.

Dwarf Gray Sugar. Gray seed; height, 2 feet. Pkt., 10c.; 35c. per lb.; 2 lbs., 60c.; \$1.40 per 5 lbs.; 10 lbs., \$2.60; \$6.00 per 25 lbs.

Tall Melting Sugar. Gray seed; height, 4 feet. Pkt., 10c.; 40c. per lb.; 2 lbs., 70c.; \$1.50 per 5 lbs.; 10 lbs., \$2.80; \$6.50 per 25 lbs.

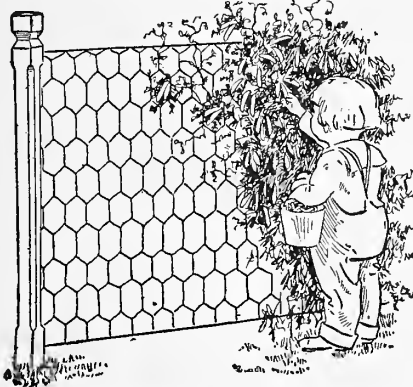

WIRE PEA TRELLIS

The ideal support for garden peas and sweet peas; neater, more economical than brush; can be rolled up when the season is over and stored. Made of strong galvanized netting and substantial uprights; neatly painted and finished. Ten-foot sections, 48 inches high. Price, \$1.50 each.

No. 1—MANIFOLD PEA TRELLIS (Wood)

The ideal arrangement for Sweet Peas and Garden Peas supports. When fully opened it makes a trellis 19 ft. long and this is varied according to the height of the plants it is to support. Positively the best of its kind that has ever come to our notice. It can be set up in 5 minutes, taken down in less and folds so that it occupies a very small space. Complete and ready to put up; stained green. Each, \$3.00; doz., \$35.00.

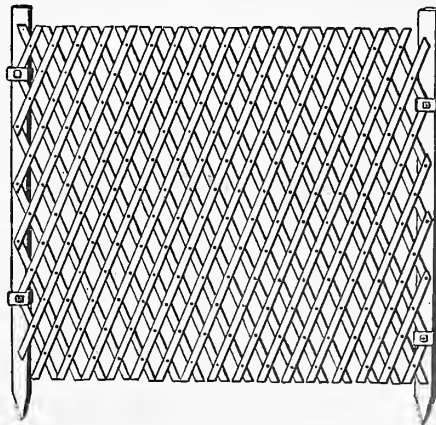

NITROGEN GATHERING BACTERIA

For promoting the growth of peas and big crop yields, will be found of great advantage; it encourages vigorous vines, well-filled pods, and makes it possible for the plants to withstand drought and disease better. When ordering be sure and specify for what crop this is wanted. We offer the following brands:

Mulford Germ. 35c. per trial bottle; 75c. per ¼-acre bottle; 1-acre bottle, \$1.50.

Standard Bacteria. Trial size, 25c.; garden size, 50c.; 75c. per acre bottle.

Farmogerm. ¼ acre size, 50c.; \$1.00 per acre size.

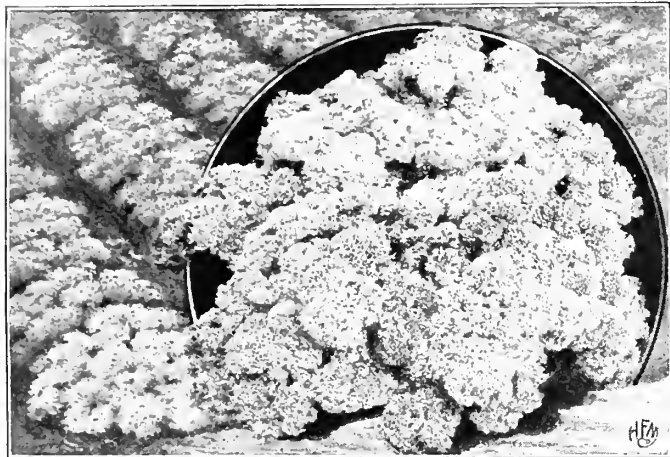

Doubled Curled Parsley

PARSLEY

Persil (Fr.); Petersilie (Ger.); Prezzemolo (Ital.)

One ounce will sow a row 100 ft. long.

After soaking the seed for a few hours in warm water, it should be sown in rows 18 inches apart, and when 2 inches high thinned out so the plants will stand 4 inches apart in the row. It takes parsley seed from 3 to 6 weeks ordinarily to germinate, so that a little patience in growing this is necessary. Parsley can be continued over winter, if given a heavy covering of long manure.

Champion Moss Curled. Beautifully crimped and curled. It can be cut the year round. Pkt., 5c.; 10c. per large pkt.; oz., 15c.; 45c. per ¼ lb.; lb., \$1.25.

Double Curled or Covent Garden. A great improvement over all other varieties; nicely curled leaf which has a tendency to retain its deep green color the entire season. Pkt., 10c.; 20c. per oz.; ¼ lb., 60c.; \$1.50 per lb.

Hamburg or Rooted. The fleshy roots are used for flavoring soups, stews, etc. Pkt., 10c.; 15c. per oz.; ¼ lb., 45c.; \$1.25 per lb.

All seeds offered on this page (not plants) mailed postpaid at quoted prices.

PARSLEY PLANTS (Ready in April)

Large specimens; pot-grown, ready for use. 10c. each; doz., \$1.00; \$7.00 per 100. These plants cannot be mailed satisfactorily.

PARSNIP

Panais (Fr.); Pastinake (Ger.); Pastinaca (Ital.)

One ounce will sow a row 150 feet long; 5 lbs. per acre.

Sow early in the spring in drills about 24 inches apart, covering the seed slightly; when the plants are 2 or 3 inches high, thin out so the roots will develop; cultivate well during the growing season.

Improved Sugar or Hollow Crown. A very thick, broad-topped root, which makes it lift easily. Flesh is very fine grained and sweet, while the outer surface is smooth and almost white. It yields enormous crops. Pkt., 5c.; 10c. per large pkt.; oz., 20c.; 60c. per ¼ lb.; lb., \$2.00.

PEPPER

Piment (Fr.); Pfeffer (Ger.); Peperone (Ital.)

One ounce produces 1200 plants.

Sow the seed in a hotbed or window box about March 1st. Transplant to the open when all danger from frost is over, in rows 3 feet apart, 15 inches apart in the row.

Bell or Bull Nose. Very thick flesh; a great producer. The large fruits are green, turning to vivid scarlet; fine for slicing on tomatoes, or stuffed as mangoes. Pkt., 5c.; 10c. per large pkt.; ½ oz., 20c.; 35c. per oz.; ¼ lb., \$1.10.

Cayenne. A long red variety; very hot and used principally for bunching with pot herbs. Pkt., 10c.; 20c. per ½ oz.; oz., 35c.; \$1.10 per ¼ lb.

Chinese Giant. A monster pepper; perfectly sweet; green fruit, turning bright scarlet; matures very late; a very shy seeder. Fine for stuffed mangoes. Pkt., 10c.; 35c. per ½ oz.; oz., 65c.; \$2.25 per ¼ lb.

Golden Dawn. A large yellow variety, shaped like the Chinese Giant; very sweet. Pkt., 10c.; 20c. per ½ oz.; oz., 40c.; \$1.25 per ¼ lb.

Neapolitan. Early; large size; mild flavor; bright red when ripe. See illustration and full description on page 6. Pkt., 10c.; 20c. per ½ oz.; per oz., 35c.; \$1.20 per ¼ lb.

Pimiento. A splendid, uniformly shaped, sweet variety. Green fruit changing to red when fully ripe. Pkt., 10c.; 25c. per ½ oz.; oz., 45c.; \$1.50 per ¼ lb.

Ruby Giant. Very large; adapted for stuffing; mild flavor. Pkt., 10c.; 20c. per ½ oz.; oz., 40c.; \$1.25 per ¼ lb.

Ruby King. A large red variety resembling Bull Nose. Pkt., 10c.; 20c. per ½ oz.; oz., 35c.; \$1.10 per ¼ lb.

World Beater. This variety is very similar to Ruby Giant, in fact some claim it to be an improvement over that variety. Choice seed, grown in New Jersey. Pkt., 10c.; 20c. per ½ oz.; oz., 40c.; \$1.25 per ¼ lb.

PEPPER PLANTS (Ready in May)

Pot-grown Plants. 10c. each; doz., \$1.00; \$7.00 per 100.

Testimonial

Jackson, Miss.

I ordered some seed from you last Fall, and they gave me better satisfaction than any seed I have ever planted.

Mrs. W. J.

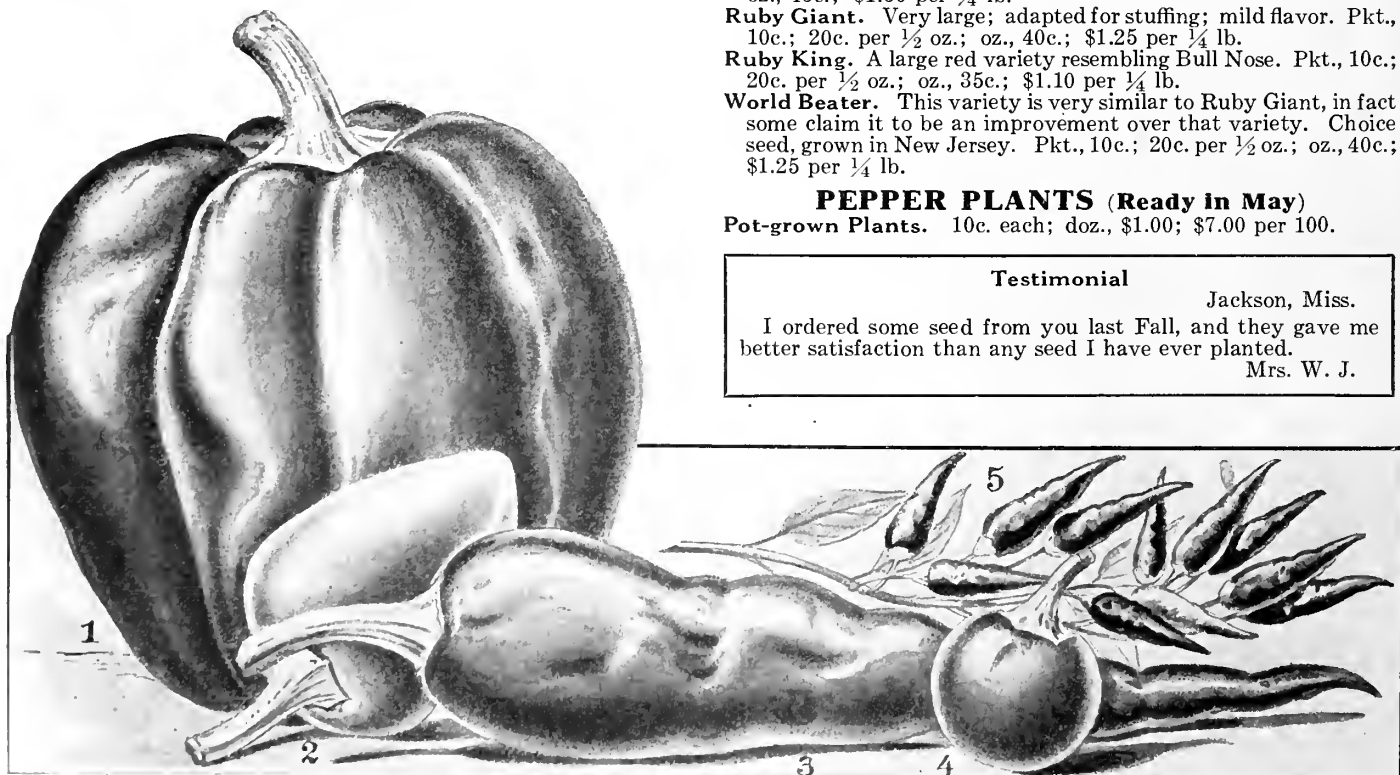

PEPPERS. 1, Chinese Giant. 2, Pimiento. 3, Cayenne.

Pomme de Terre (Fr.); Kartoffel (Ger.); Patata (Ital.)

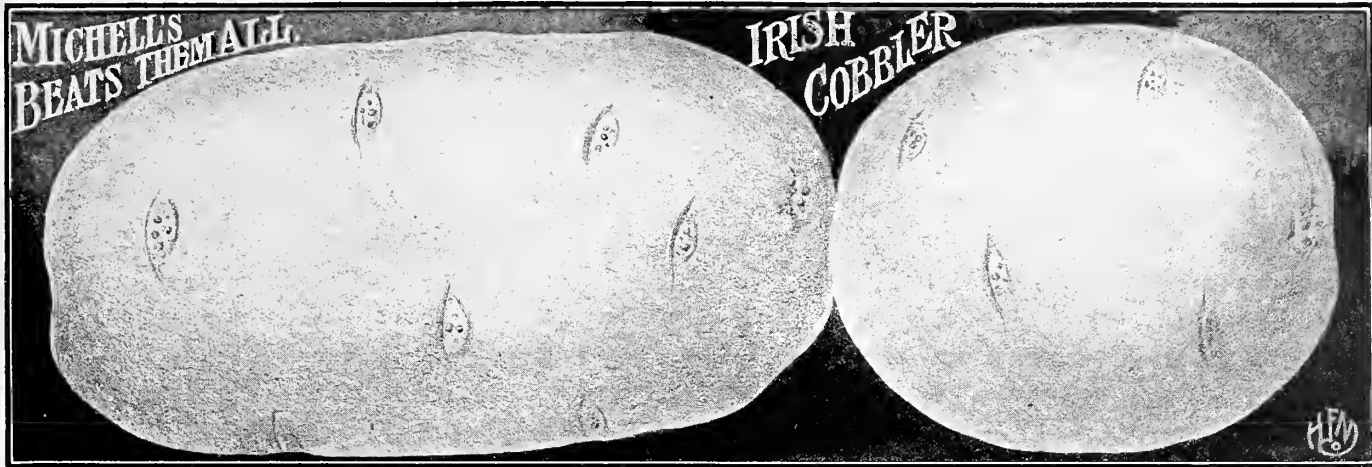

TIME OF SHIPMENT.—Potato shipping with us commences about March 15th (weather permitting), unless otherwise requested. We can ship at customer's risk any time during cold weather.

Our potatoes are put up in barrel sacks of 165 lbs. each. Shipment in barrels can be made at a cost of 75c. each for barrels.

Beats Them All (Michell's). This famous variety has given the best results wherever tried, yielding more than any other early potato; quality fine; extremely early, coming in about one week or ten days earlier than Early Rose. Oblong in shape.

Bliss Triumph, or Red Bliss. A very early thin-skinned variety; they are frequently offered as Southern or Bermuda potatoes.

Dibbles Russet. A splendid late variety; claimed to be absolutely rust and blight proof; medium size; oval or flat in shape.

Early Rose (Houlton or Maine). A leading variety for earliness, quality and productiveness; pink skin; oblong shape.

Gold Coin. This potato seems to be in great demand, though by no means a new one. It is large, somewhat roundish flat and a wonderful cropper; a late maturer.

Green Mountain. An excellent general crop variety; white, roundish flat.

Irish Cobbler. A splendid sort, almost round in shape.

Jersey Red Skin. These are especially adapted for planting in light, sandy soil late in June and in early July. They are oval shaped, medium size and cook pure white.

State of Maine. An old favorite, grown by every gardener; good keeper; flat in shape.

SWEET POTATO PLANTS (Ready in May)
Yellow and Red Nansemond. Per 100, 75c.; \$5.00 per 1000.
 We regret we cannot supply tubers of sweet potatoes.

HYBRIDIZED POTATO SEED
 Growing new and distinct Seedling Potatoes from the seed is intensely interesting. Pkt., 15c.; 25c. for 2 pkts.

CONCAVE POTATO KNIFE
 Made of best steel with concave blade. Price, 30c.; 4 for \$1.00.

POTATO SCAB DESTROYER
(A Formaldehyde)



Dilute 1 quart in 25 gallons of water and soak the seed potatoes in this solution for 2 hours before cutting. They should then be taken out and dried; 25 gallons treating liquid is sufficient for approximately 15 bushels of potatoes. 85c. per pt.

THE POTATO (Fraser)
 A practical treatise on this important crop. \$1.00, postpaid.

Prices on Seed Potatoes are established about March 1st.

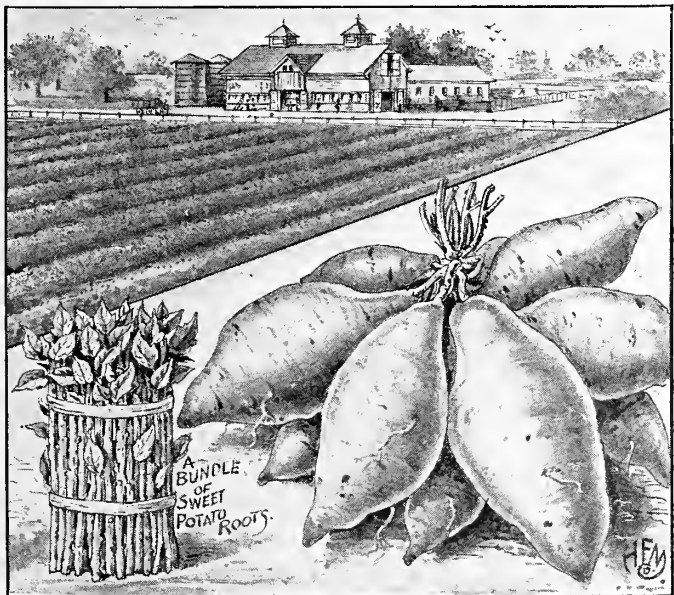

Sweet Potatoes

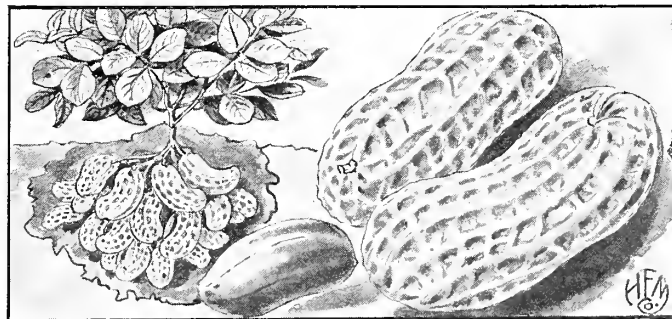

PEANUTS

Arachide (Fr.); Erdnuss (Ger.); Cece de terra (Ital.)

One bushel nuts unshelled will plant an acre, but shell must be removed beforehand.

It is generally believed peanuts cannot be grown anywhere north of Virginia, but this is a mistake; most any well-drained garden soil suits them, where they will yield a big crop. The peanut plant rather enriches the soil instead of impoverishing it, as it is an abundant gatherer of free nitrogen.

Selected Virginia. 1/2 lb., 20c.; 40c. per lb.
PENNYROYAL (Herb). Pkt., 10c.; 30c. per 1/2 oz.; oz., 60c.

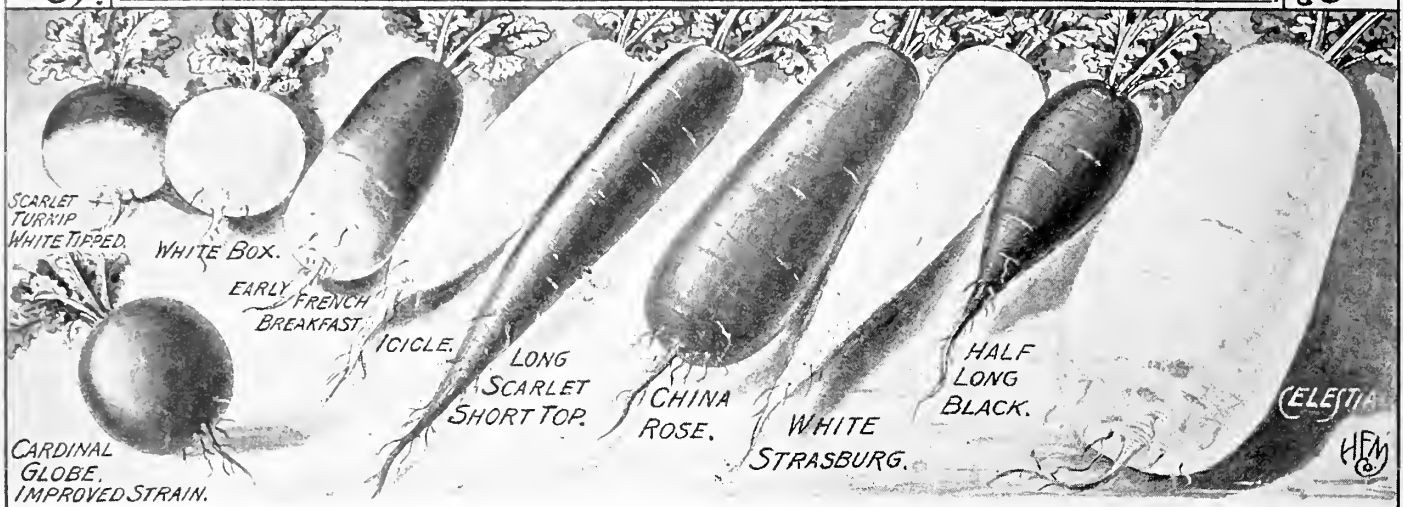

Radis (Fr.); Radies (Ger.); Ravanelli (Ital.)

One ounce of seed will sow a row about 75 feet long; 8 to 10 lbs. are required for an acre.

Radishes should be sown in good rich ground, where they can make rapid growth, for then only do they produce the best results. The winter radishes are sown in July and are developed by autumn, at which time they may be taken up and stored in a cool cellar and covered with sand.

EARLY VARIETIES

Cardinal Globe (Improved Strain). This popular radish will be welcomed readily in an improved form. The color and shape, a vivid scarlet oval form, are perfect. Pkt., 10c.; 20c per oz.; $\frac{1}{4}$ lb. 60c.; \$2.00 per lb.

Early French Breakfast. Oblong shape; rapid grower; very mild and tender; of a beautiful scarlet color, tipped with white. Pkt., 10c.; 15c. per oz.; $\frac{1}{4}$ lb. 45c.; \$1.25 per lb.

Early Scarlet Globe (Special Forcing). A popular variety for hot-bed or greenhouse forcing; also valuable for outdoor planting; very early, crisp and mild. See illustration on page 7. Pkt., 10c.; 25c. per oz.; $\frac{1}{4}$ lb., 65c.; \$2.25 per lb.

Icele (Improved Strain). A magnificent white variety of fine taste; grows $3\frac{1}{2}$ to 4 in. long in 22 days. Also suitable for summer sowing. Pkt., 10c.; 15c. per oz.; $\frac{1}{4}$ lb., 50c.; \$1.50 per lb.

Long Scarlet Short Top, or Salmon. A favorite variety; long, bright scarlet with small top. Pkt., 10c.; 15c. per oz.; $\frac{1}{4}$ lb., 45c.; \$1.25 per lb.

Round Red Forcing, or Button. Very quick in maturing; splendid for hotbed or garden culture. 5c. per pkt.; large pkt., 10c.; 15c. per oz.; $\frac{1}{4}$ lb., 45c.; \$1.25 per lb.

Scarlet Turnip, White Tipped. Fine early scarlet variety with white tip. Pkt., 10c.; 15c. per oz.; $\frac{1}{4}$ lb., 45c.; \$1.25 per lb.

White Box, Felton's (Private Stock). A selection of the old reliable White Box radish; more perfect form, producing shorter tops, and does not have a tendency to grow long in shape. 5c. per pkt., large pkt., 10c.; 15c. per oz.; $\frac{1}{4}$ lb., 45c.; \$1.25 per lb.

SUMMER AND WINTER VARIETIES

Celestial, or White Chinese. Large size. Pure white; excellent keeper. Pkt., 10c.; 15c. per oz.; $\frac{1}{4}$ lb., 45c.; \$1.25 per lb.

China Rose. Bright rose color; flesh firm. One of the best for winter use. Half-long in shape with a scarlet blunt tip. Pkt., 10c.; 15c. per oz.; $\frac{1}{4}$ lb., 45c.; \$1.25 per lb.

Half Long Black. A great improvement on the old Long Spanish Radish. Pkt., 10c.; 15c. per oz.; $\frac{1}{4}$ lb., 40c.; \$1.00 per lb.

White Strasburg. Oblong; of a pure white color, and mild flavor; a splendid variety for summer. Pkt., 10c.; 15c. per oz.; $\frac{1}{4}$ lb., 45c.; \$1.25 per lb.

NOTE—All seeds offered on this page are mailed postpaid at prices quoted.

PUMPKIN

Potiron (Fr.); Kurbis (Ger.); Zucca (Ital.)

One ounce will plant 25 hills; 4 to 6 lbs. for an acre.

Plant any time after the ground has become permanently warm, about four seeds to the hill; the latter to be about 8 feet apart each way. To obtain strong vines, they may be pinched back somewhat, and if large specimens are desired, leave but one or two pumpkins on a vine. Do not plant near other vine crops, as they may hybridize the latter and spoil the taste; they can also be planted among corn after the last working.

Cashaw, or Golden Crook Neck. A very meaty sort; suitable for pie or stock feeding purposes; flesh golden yellow and very tender. Pkt., 10c.; 20c. per oz.; $\frac{1}{4}$ lb., 65c.; \$2.00 per lb.

Connecticut, or Common Field. Shape almost round; fruits produced in great abundance; flesh coarse and suitable only for stock feeding; color light yellow. Pkt., 10c.; 15c. per oz.; $\frac{1}{4}$ lb., 50c.; \$1.50 per lb.

Japanese Pie. A crook-necked variety; deep green with darker stripes, which turn to a rich golden yellow. The fruit sets and matures early. The name given to it is derived from the seed, which is curiously marked like Japanese letters of the alphabet. Pkt., 10c.; 20c. per oz.; $\frac{1}{4}$ lb., 65c.; \$2.00 per lb.

Large Cheese. A very large, flat-ribbed fruit, of a beautiful, buff yellow color; the interior is of fine quality. An enormous producer; ideal for market, home gardens and canning purposes. Pkt., 10c.; 15c. per oz.; $\frac{1}{4}$ lb., 50c.; \$1.50 per lb.

Large Tours, or Mammoth. The biggest pumpkin in cultivation, producing fruits that often weigh 200 lbs. When fully ripened it is of a golden orange color, free from stringiness and ideal for pie-making or cooking. Pkt., 10c.; 20c. per oz.; 60c. per $\frac{1}{4}$ lb.; \$2.00 per lb.

Tennessee Sweet Potato. An oblong-shaped, medium-sized fruit, with a very light buff yellow skin. For pies it is delicious while for cooking for table use it is dry and tasty, resembling the flavor of mashed sweet potatoes. Pkt., 5c.; 10c. per large pkt.; oz., 20c.; 60c. per $\frac{1}{4}$ lb.; lb., \$2.00.

Winter Luxury. Known as the New England pie pumpkin. No Thanksgiving dinner is complete without the palatable pumpkin pie made from this variety. This is also used for making Jack-o-Lanterns, for which purpose it is well suited, on account of its very round and symmetrical shape. The skin is a russet yellow, while the flesh is golden orange when ripe. Pkt., 10c.; 20c. per oz.; $\frac{1}{4}$ lb., 60c.; \$2.00 per lb.



RHUBARB (See Illustration above)

Rhubarbe (Fr.); Rhabarber (Ger.); Rabarbaro (Ital.)
 Seed should be sown outdoors in April in rows 3 ft. apart. The following spring the roots should be transplanted into permanent beds and placed 3 feet apart each way; the year following that, or two years after sowing the seed, the rhubarb may be used. Do not cut rhubarb, pull it so that it comes out whole from the crown. Roots may be planted in October or in the Spring up to May 15th.
Victoria. Immense long stalks of a cherry-red color; a most popular variety. Pkt., 10c.; 20c. per oz.; 65c. per ¼ lb.; \$2.25 per lb.

RHUBARB ROOTS

Victoria, First Size Roots. 15c. each (by mail 20c.); doz., \$1.50; \$10.00 per 100.
Victoria, Mammoth Roots. For forcing, or outdoor planting. 35c. each (not mailable); doz., \$3.50; \$6.25 for 25; 100, \$22.50.

RUTA BAGA

Ruta Bagas should be sown in drills about 30 inches apart, and when 3 inches high, thinned out. Ruta Bagas should not be sown before the 1st of August in the Philadelphia latitude; if sown too early they develop long instead of round roots.

Private Stock Purple Top Yellow. This is the perfect ideal Ruta Baga. Top is purple, the bottom yellow. Pkt., 5c.; 10c. per large pkt.; oz., 15c.; 30c. per ¼ lb.; lb., 85c.

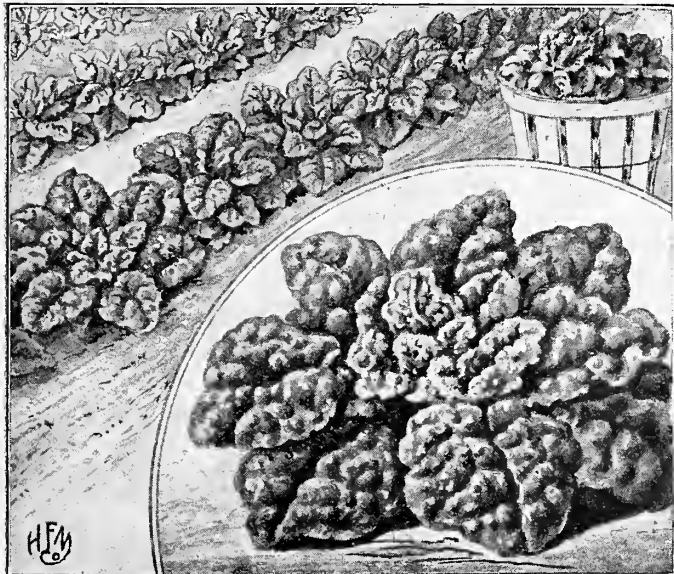

Spinach, Michell's Improved Strain Bloomsdale

NOTE.—All seeds on this page sent postpaid at quoted prices.

VARIOUS HERBS

Partial list, in alphabetical order. For complete, condensed, list see page 36.

	Pkt.	½ oz.	Oz.
Rosemary	\$0.10	\$0.50	\$0.85
Saffron	.10	.20	.35
Sage	.10	.40	.75
Summer Savory	.10	.15	.30
Sweet Basil	.10	.20	.35
Sweet Marjoram	.10	.20	.35

SORREL

Oseille (Fr.); Sauerampfer (Ger.); Acetosa (Ital.)
 Relished principally by the French people, who use it as a spinach dressing; also as a salad. Has an acid flavor. A sowing lasts a number of years. The seed stalks should be cut off when they appear. Pkt., 10c.; 25c. per oz.; 65c. per ¼ lb.; \$2.25 per lb.

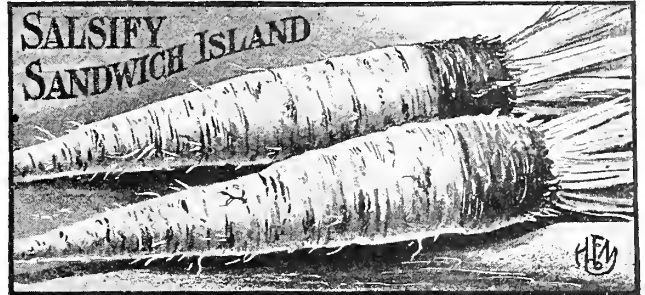

SALSIFY (Oyster Plant)

Salsifs (Fr.); Hafer Wurzel (Ger.); Salseña (Ital.)
One ounce of seed to 50 feet of drill. 10 lbs. per acre.
 Sow in early spring, in drills fifteen inches apart and one to two inches deep; when about 4 inches high, thin to three inches apart. Soil should be very deep and mellow in order that the root may grow straight down. Store same as carrots for winter use, or they can be left in the ground until spring. This is one of the finest vegetables stewed and served with a cream dressing.
Mammoth Sandwich Island. This variety is of enormous size, twice as large as the ordinary white variety; very tender and delicious. Pkt., 10c.; 25c. per oz.; ¼ lb., 85c.; \$3.00 per lb.

SHALLOTS (French Flavoring Onions)

(See page 26.)

SPINACH

Epinaud (Fr.); Spinar (Ger.); Spinaccio (Ital.)
 One ounce will sow a row about 75 feet long; 10 to 12 pounds are required for an acre. Sow for spring use, in drills one foot apart (covering the seed about one-half inch) as early as the ground can be worked, and continue to sow every two weeks till May 15th. Spinach seed seldom germinates during June, July or August, so we do not recommend sowing again until September, which is the season to provide an early winter and spring crop. On the approach of cold weather cover with long manure, salt hay, straw or other suitable litter. For a supply of spinach during summer, the New Zealand variety is sown in April or May. Spinach can also be grown successfully under hotbed sash.

Bloomsdale Round-Seeded Savoy (Improved Strain). The hardiest variety; curled and crimped; thick, fleshy leaves; the best for early spring and fall sowing. Oz., 10c.; 20c. per ¼ lb.; per lb., 65c.; \$3.00 for 5 lbs.

Long Season. A cross between the Bloomsdale and the Victoria Long Standing. It produces tremendously large plants and leaves, which are strong and robust. It will resist heat better without shooting to seed than any variety yet introduced. The leaves are somewhat curled and are tender. Color, a beautiful dark green. 10c. per oz.; ¼ lb., 20c.; 65c. per lb.; 5 lbs. for \$3.00.

Market Gardeners (New). An improvement on all other varieties; leaves broad, heavy and of a dark green glossy color; very slow to run to seed and of excellent quality. See illustration on page 7. 10c. per oz.; ¼ lb., 30c.; \$1.00 per lb.; 5 lbs., \$4.50.

New Zealand. This variety endures heat and drought; excellent for summer use; the leaves are small and thick. It is a heavy yielder, growing upright; one sowing can be picked from the entire summer. A very distinct variety. Pkt., 10c.; 15c. per oz.; ¼ lb., 40c.; \$1.00 per lb.; 5 lbs., \$4.00.

NOTE—All seeds on this page are sent postpaid at prices quoted.

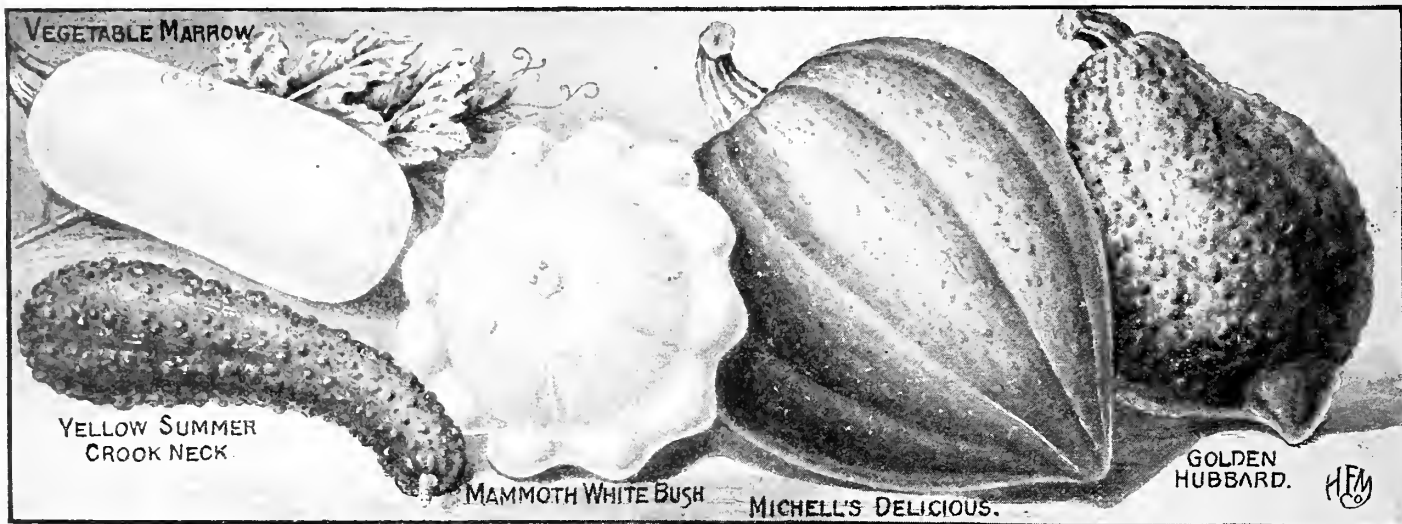

SQUASH

Course (Fr.); Kurbis (Ger.); Zucca (Ital.)
 One ounce will plant 20 to 50 hills, 3 to 4 lbs. are required for an acre.

This vegetable is a popular one for summer and winter use, and being susceptible to cold it should not be planted until the ground is thoroughly warm. There are two varieties, the bush sort being planted in hills 4 to 5 feet apart each way; the running varieties require planting 8 to 15 feet apart in order that the fruits may develop properly. Place 8 to 10 seeds in a hill, and when the third stage of leaves are set, thin out to about 4 plants in a hill.

SUMMER VARIETIES

Cocozele. This is a bush variety with smooth fruits, dark green in color, striped deeper. Pkt., 10c.; 20c. per oz.; ¼ lb., 70c.; \$2.25 per lb.

Golden Custard. A flat scalloped type, like the White Bush; the skin is of a light yellow color, which is very thin, leaving plenty of meat in the centre; a bush or compact growing kind. Pkt., 10c.; 15c. per oz.; ¼ lb., 40c.; \$1.25 per lb.

Mammoth White Bush. Of round scalloped form with an ivory white skin. This variety has an abundance of meat of very fine flavor. It is one of the earliest to mature and is very prolific, bearing continually until killed by frost. Pkt., 5c.; 10c. per large pkt.; oz., 15c.; 50c. per ¼ lb.; lb., \$1.75.



Giant Lucullus Swiss Chard

SUMMER SQUASH (Continued)

Yellow Summer Crook Neck. Shaped like a club with a bent neck. The skin is very rough and warted, of an orange yellow color. Much preferred on account of its very dry meat when boiled. This is a running variety. Pkt., 10c.; 20c. per oz.; ¼ lb., 60c.; \$2.00 per lb.

FALL AND WINTER VARIETIES (Running Sorts)

Boston Marrow. Shaped similar to Hubbard; golden orange; fine for canning for winter use, cooked as a vegetable or in pie. Pkt., 10c.; 15c. per oz.; ¼ lb., 40c.; \$1.15 per lb.

Delicious. Well named, as it has the finest flavor of any squash; of oblong shape, with a deep green skin and thin rind, and with a seed cavity so small that it almost meets in the centre. One of the best winter keepers; grown extensively for market; when matured it weighs from 5 to 10 lbs. and is in its prime during the early winter; one of the very best. Pkt., 10c.; 20c. per oz.; ¼ lb., 70c.; \$2.00 per lb.

Golden Hubbard. Used extensively for pie, but served as a vegetable, it is very dry and delicious. The outside is a deep orange red, while the flesh is very tender. Pkt., 10c.; 20c. per oz.; ¼ lb., 65c.; \$2.00 per lb.

Vegetable Marrow. A long, greenish white variety; fine for cooking; very sweet and tender. This is the favorite squash with the English people. Pkt., 10c.; 20c. per oz.; ¼ lb., 65c.; \$2.25 per lb.

SWISS CHARD (Spinach Beet)

Poireau (Fr.); Mangold Kohl (Ger.); Bieta (Ital.)

1 oz. will sow a row about 50 feet long.

A wonderful vegetable which is known but too little. From every possible standpoint it has qualities that recommend its use in every household. Readily grown from seed, when it can be used five weeks after sowing and is a continuous crop until killed by frost. The plant does not produce a beet root, but its valuable part is all above the ground; large leaves with broad ribs grow from the centre of the plant; the outer leaves only should be carefully pulled from the plant and the foliage part separated from the rib in preparing to cook. The former when cooked is served like spinach, which it resembles in taste; the ribs when boiled and served with melted butter are the equal of finest asparagus. When hard frosts strike the plants down they can be taken up and placed in a cool cellar; the roots may be carried over this way with an occasional watering, and if planted in a hotbed about March 1st they will produce early spring greens.

Giant Lucullus. Very tall growing; crinkly leaves often two feet long; a beautiful ornamental plant for any garden. Pkt., 10c.; 15c. per oz.; ¼ lb., 50c.; \$1.25 per lb.

TARRAGON

Fine for flavoring. Plants, 30c. each; doz., \$2.50; \$18.00 per 100.

THYME (Herb)

Seed. Pkt., 10c.; 45c. per ½ oz.; oz., 80c.

THYME PLANTS

20c. each; doz., \$1.50; \$10.00 per 100.

TOBACCO

Many people like to have a few plants of this in the garden. It attracts butterflies. The flower is very sweet scented, while the leaves may be dried, cured and made into smoking tobacco and cigars. Sow in a box indoors and set outdoors in May.

Connecticut Seed Leaf	Pkt. \$0.15
Havana15
Pennsylvania Seed Leaf15

MICHELL'S
PRIVATE STOCK
STONE TOMATO.

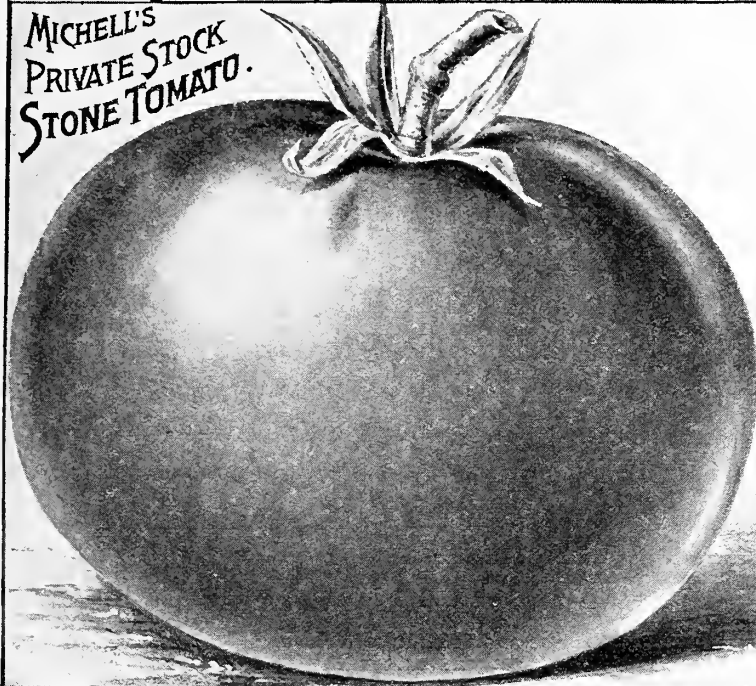

MICHELL'S
GLOBE TOMATO.

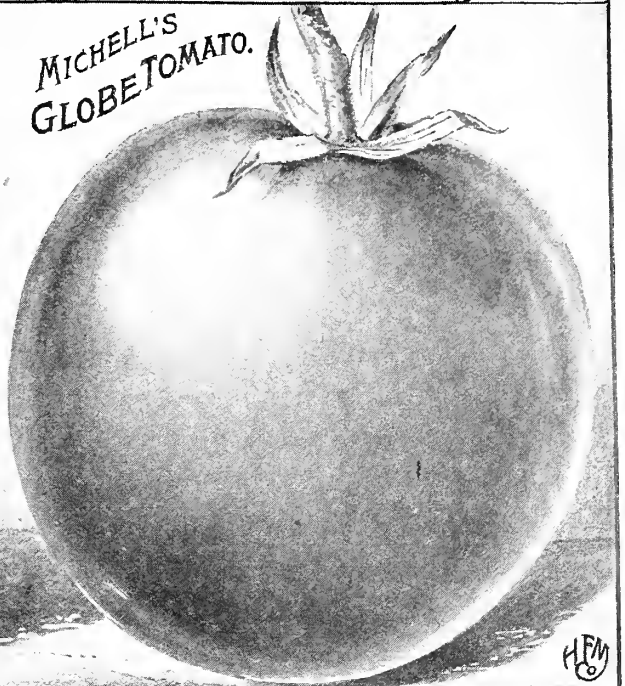

Pomme d'Amour (Fr.); Liebsapfel (Ger.); Pomo d'oro (Ital.)

One ounce will produce 3500 plants; 1/4 lb. will provide enough plants for an acre.

Sow in the house or hotbed about March 1st, transplant when 3 inches high, and again later to produce vigorous specimens. Set plants outdoors about May 1st in rows 3 feet apart, 18 inches in the row, or in hills 4 feet apart each way. Properly grown tomato plants should be supported.

Note.—All seeds on this page mailed postpaid at prices quoted.

- Beauty.** One of the largest bright red tomatoes; solid and meaty; quite early. Pkt., 10c.; 20c. per 1/2 oz.; oz., 35c.; \$1.25 per 1/4 lb.
- Bonny Best.** One of the most prolific of early tomatoes. The size is not so large, but it is very solid and evenly formed. Color, bright red. Pkt., 10c.; 20c. per 1/2 oz.; oz., 35c.; \$1.25 per 1/4 lb.
- Chalk's Early Jewel.** Extra early; bright red; fine flavor; very productive. 10c. per pkt.; 1/2 oz., 20c.; 35c. per oz.; 1/4 lb., \$1.25.
- Crackerjack (Michell's.)** This is one of the best early tomatoes for the home garden, its productiveness being wonderful; quite free from acid and of a convenient size. Color, rich red and produced in clusters. Be sure and try it if you have not already done so. Pkt., 10c.; 30c. per 1/2 oz.; oz., 50c.; \$1.75 per 1/4 lb.
- Dwarf Champion.** A distinct type; the plant looks like a miniature tree; very dwarf and compact; bright red; very solid; late maturer. Pkt., 10c.; 20c. per 1/2 oz.; oz., 40c.; \$1.40 per 1/4 lb.
- Dwarf Stone.** A dwarf, compact growing plant, yielding a large crop of medium-sized, very solid tomatoes. Color, bright red. The plant is very distinct and upright; late cropper. Pkt., 10c.; 20c. per 1/2 oz.; oz., 40c.; \$1.40 per 1/4 lb.
- Earliana (Spark's).** A very prolific tomato. Grows in clusters; medium in size, solid and very desirable. 5c. per pkt., large pkt., 10c.; per 1/2 oz., 20c.; oz., 35c.; \$1.25 per 1/4 lb.
- Early Red Wonder (Michell's).** A splendid early, new variety; for complete description and illustration see page 7. Pkt., 10c.; 30c. per 1/2 oz.; oz., 50c.; \$1.75 per 1/4 lb.
- Greater Baltimore.** A main crop variety; fruit large and of a brilliant red color; ripens evenly to the stem. Pkt., 10c.; 15c. per 1/2 oz.; oz., 30c.; \$1.00 per 1/4 lb.

- Golden Queen.** Large yellow fruit; very sweet, almost free from acid; splendid for preserving or for slicing; to those who generally (on account of acidity) do not eat tomatoes, we can recommend this variety. Pkt., 10c.; 20c. per 1/2 oz.; per oz., 40c.; \$1.40 per 1/4 lb.
- John Baer.** This is positively without exception the earliest tomato that we know of. The plant is very dwarf, growing in tree form and frequently the plants have small tomatoes on while yet in pots ready to be set out. Fruit is bright red. Pkt., 10c.; 20c. per 1/2 oz.; oz., 35c.; \$1.25 per 1/4 lb.
- Livingston's Globe.** Especially adapted to slicing; very solid; a handsome red, and a great producer; one of the best general crop varieties. Pkt., 10c.; 25c. per 1/2 oz.; per oz., 45c.; \$1.40 per 1/4 lb.
- Matchless.** Large red fruit; a general crop variety. Pkt., 10c.; 20c. per 1/2 oz.; 35c. per oz.; \$1.20 per 1/4 lb.
- Ponderosa.** The largest tomato in existence; a beautiful deep pink; rather uneven at times in shape. Pkt., 10c.; 30c. per 1/2 oz.; per oz., 60c.; \$2.00 per 1/4 lb.
- Red Rock.** One of the most solid varieties; medium early and of a brilliant red color; a fine one for the home or market garden. Pkt., 10c.; 15c. per 1/2 oz.; per oz., 30c.; \$1.00 per 1/4 lb.
- Stone (Michell's Private Stock).** A very careful selection of the old favorite Stone. The fruits are larger, more even, and produced in greater abundance. 5c. per pkt.; large pkt., 10c.; 15c. per 1/2 oz.; per oz., 30c.; **FORCING TOMATOES**
Pkt. 1/2 Oz. Oz.
Best of All \$0.10 \$0.30 \$0.50
Comet10 .30 .50
Eclipse
(Orig. pkts.) 1.00
SMALL FRUITED TOMATOES
Pkt. 1/2 Oz. Oz.
Red Cherry \$0.10 \$0.30 \$0.50
Red Peach .10 .30 .50
Yellow
Plum10 .30 .60
Strawberry
or Husk . . .10 .30 .60
TOMATO PLANTS
(Ready in April). (See page 37)
Pot Crown, Doz. 100
leading sorts . . . \$0.75 \$5.00

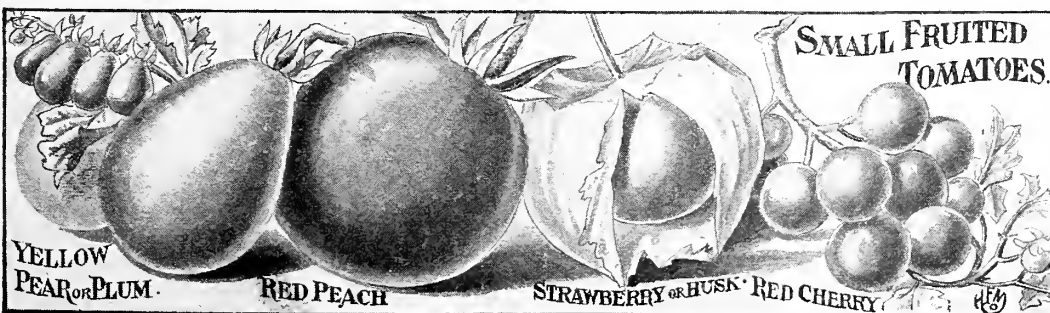

	Pkt.	1/2 Oz.	Oz.
Best of All	\$0.10	\$0.30	\$0.50
Comet	.10	.30	.50
Eclipse			
(Orig. pkts.)	1.00		
SMALL FRUITED TOMATOES			
	Pkt.	1/2 Oz.	Oz.
Red Cherry	\$0.10	\$0.30	\$0.50
Red Peach	.10	.30	.50
Yellow			
Plum	.10	.30	.60
Strawberry			
or Husk	.10	.30	.60
TOMATO PLANTS			
(Ready in April). (See page 37)			
Pot Crown,	Doz.	100	
leading sorts	. . .	\$0.75	\$5.00

MICHELL'S TURNIP AND RUTA BAGA SEED.

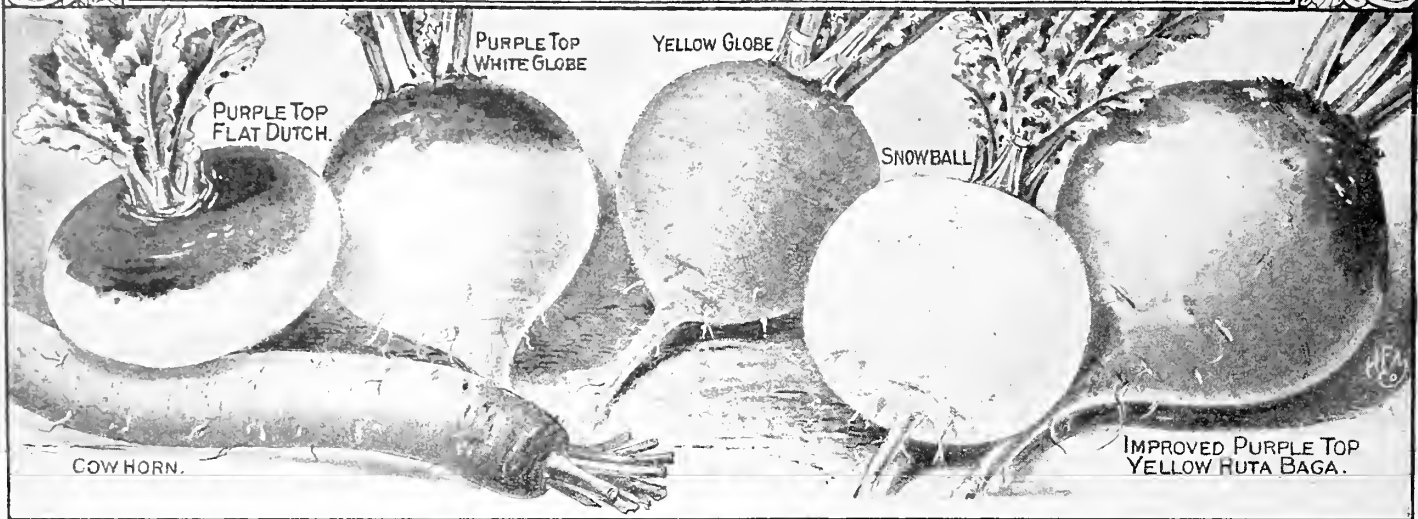

Herbst Ruben (Ger.); Navet (Fr.); Navone, Rapa (Ital.)

One ounce of seed for 100 feet of drill; two lbs. per acre, broadcast.

For early use sow the small sorts as soon as the ground can be worked in the spring in drills 14 inches apart. Ruta Bagas should be sown in drills 30 inches apart. As the seed is fine it should be covered but slightly, except in very dry weather. Do not sow too thickly, so the roots can develop. For fall and winter use sow broadcast from the middle of July to the middle of August, and Ruta Bagas in drills from the middle of June to the fifteenth of August. Ruta Bagas sown early have a tendency to grow long in shape, while seed sown in August usually develops roots of a uniform globular shape.

TURNIP

- Aberdeen.** A flat yellow variety; a good winter keeper. Pkt., 10c.; 15c. per oz.; ¼ lb., 30c.; 85c. per lb.
- Cow Horn.** A long white variety, used for soiling and stock feeding. Pkt., 10c.; 15c. per oz.; ¼ lb., 30c.; 85c. per lb.
- Early Purple Top Flat.** The most popular variety in cultivation; a large yielder; well flavored. 5c. per pkt.; large pkt., 10c.; 15c. per oz.; ¼ lb., 30c.; 85c. per lb.
- Purple Top White Globe (Private Stock).** This is a careful selection of the popular Purple Top Globe variety; it is very uniform in shape and one that should be grown by all who grow turnips. Our strain of seed is especially fine. Pkt., 10c.; 15c. per oz.; ¼ lb., 30c.; 85c. per lb.
- Snowball.** A pure white globe variety; very early. Pkt., 10c.; 15c. per oz.; ¼ lb., 30c.; 85c. per lb.
- Southern Seven Top.** For winter greens chiefly; extensively sown in the South. Pkt., 10c.; 15c. per oz.; ¼ lb., 30c.; 85c. per lb.
- Yellow Globe or Amber.** Shaped like the Purple Top Globe, but the color is like that of a Yellow Ruta Baga. Pkt., 10c.; 15c. per oz.; ¼ lb., 30c.; 85c. per lb.

RUTA BAGA

Ruta Bagas should be sown in drills about 30 inches apart and when 3 inches high thinned out to get the greatest root development. They need to be cultivated liberally and hilled up when about 6 inches high.

Customers frequently complain that Ruta Bagas grow too long in shape, rather than in a round form. Careful inquiry has developed the fact that this is caused by sowing the seed too early.

In the locality of Philadelphia and New York the seed should not be sown until August 1st, when it will invariably develop perfectly globular formed roots. Seed sown earlier than this invariably produces the long shaped roots with long stems.

Private Stock Purple Top Yellow. This is the perfect ideal Ruta Baga. Top is purple, the bottom yellow. It brings a high price when sold in the market on account of its shape. 5c. per pkt.; large pkt., 10c.; 15c. per oz.; ¼ lb., 30c.; 85c. per lb.

NOTE.—All seed offered on this page mailed free at quoted prices.

SEEDS OF CULINARY AND MEDICINAL HERBS

A few herbs in the garden will be found very convenient, there being so many uses to which they can be put in the green and also dry state. For winter use, they should be cut just as they come into flower, tied in bunches and hung in a light, airy place indoors, where they can be available any time.

	Pkt.	½ oz.	Oz.		Pkt.	½ oz.	Oz.		Pkt.	½ oz.	Oz.
Anise	\$.10		\$.20	Dill	\$.10		\$.20	*Sage	\$.10	\$.40	\$.75
Basil, Sweet	.10	\$.20	.35	*Fennel, Sweet	.10	\$.15	.25	Savory, Summer	.10	.15	.30
Borage	.10	.20	.35	Fennel, Florence	.10	.20	.40	*Savory, Winter	.10	.30	.50
Caraway	.10		.20	*Lavender	.10	.25	.40	Sweet Marjoram	.10	.20	.35
*Catnip	.15			*Mint, Peppermint	.25			*Thyme, Broad Leaved	.10	.45	.80
Chamomile	.10	.30	.50	*Pennyroyal	.10	.30	.60	*Varieties are hardy or perennial, while others must be sown each season.			
*Chives	.10			*Rosemary	.10	.50	.85				
Coriander	.10		.20	Saffron	.10	.20	.35				

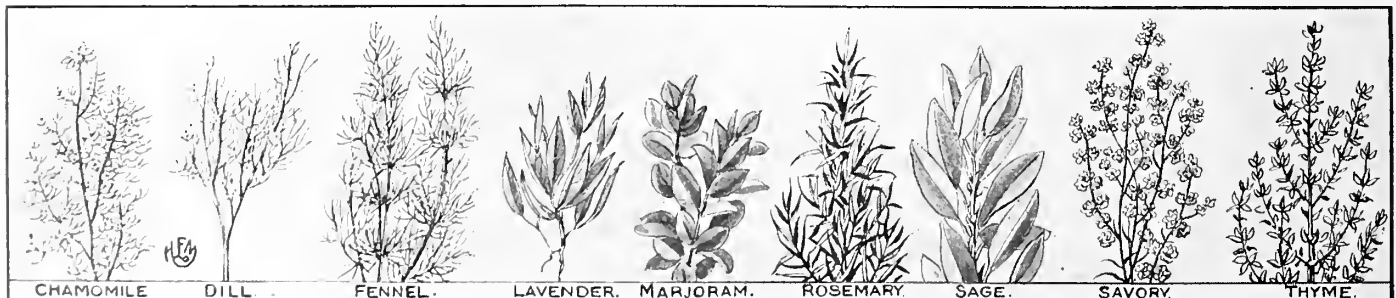



VEGETABLE AND HERB PLANTS AND ROOTS

We have fresh supplies of this stock in daily, during the season of planting; we grow them at our own nurseries, and in extra good quality.

ARTICHOKEs (Ready in April)

Green Globe. Pot grown. \$1.50 per doz.; 25 for \$3.00; \$10.00 per 100 (by express only).
Jerusalem. Used for table and stock feeding. 30c. per qt.; peck, \$1.50; \$5.00 per bu.

ASPARAGUS ROOTS

(Ready from Oct. 15th to May 15th)

The two-year-old roots usually produce two years after planting, the three-year-old may be cut lightly one year after planting.

2 Year Old Roots Doz. 100 1000

Barr's Mammoth	\$0.35	\$1.75	\$12.50
Conover's Colossal35	1.75	12.50
Giant Argenteuil35	1.75	12.50
Palmetto or Eclipse35	1.75	12.50
Washington (Rust Proof) New75	3.50	30.00

3 Year Old Roots

Barr's Mammoth45	2.25	17.50
Conover's Colossal45	2.25	17.50
Giant Argenteuil45	2.25	17.50
Palmetto or Eclipse45	2.25	17.50

BRUSSELS SPROUTS (Ready in July)

Matchless Improved (Hotbed Grown). 25 for 25c.; 75c. per 100; per 1000, \$6.00. If wanted by mail, add 10c. per 100 for postage.

CABBAGE PLANTS

(Ready in season beginning April 1st)

Early Sorts. From hotbeds. Wakefield and All Head only. Ready April 15th. 60c. per 100; per 1000, \$5.00.

Early Sorts. Sturdy plants from cold frames. Ready April 1st, in Wakefield and All Head varieties only. \$1.00 per 100; per 1000, \$7.50.

Late Sorts. Ready July 1st in Late Flat Dutch, Danish Ball Head and Red Dutch Drumhead varieties only. Per 100, 60c.; \$5.00 per 1000. If cabbage plants are wanted by mail, add 15c. per 100 for postage.

CAULIFLOWER PLANTS

(Ready April 1st)

Snowball variety only. From hotbeds. 25c. per doz.; per 100, \$1.50.

Snowball variety only. Pot-grown. 75c. per doz.; per 100, \$5.00.

If hotbed Cauliflower are wanted by mail, add 5c. per doz., or 15c. per 100 for postage charges. Pot-grown plants do not carry well when shipped via parcel post.

CELERY PLANTS (Ready in July)

White Plume, Giant Pascal, Winter Queen and Golden Self-Blanching. 75c. per 100; per 1000, \$6.00.

If Celery Plants are wanted by mail, allow 4 lbs. weight per 100 for postage.

CHIVES (Ready in April)

Strong Plants. 15c. each; doz., \$1.50; \$10.00 per 100. Allow 5c. each for mailing if wanted by parcel post.

EGG PLANTS (Ready after May 15th)

Sold in pot-grown stock only.

New York Improved and Black Beauty. 10c. each; doz., \$1.00; \$7.00 per 100.

HOP VINE (Hardy)

This makes a valuable shade plant, grown on arbors, trellis, etc.

Strong Pot Grown Plants. 25c. each; doz., \$2.50; \$18.00 per 100.

HORSE RADISH ROOTS

(Ready in March)

Maliner Kren (Bohemian). Large, strong cuttings, 35c. per doz.; per 100, \$2.00; \$15.00 per 1000.

If Horse Radish are wanted by mail, add 10c. per 100 for postage.

LAVENDER (Ready in April)

Pot-grown plants. 25c. each; per doz., \$2.50; \$18.00 per 100. If wanted by mail, add 5c. for postage.

LETTUCE PLANTS

Heading varieties; our selection only. 25 for 20c.; 75c. per 100; per 1000, \$6.00. If wanted by mail, add 10c. per 100 for postage.

MINT (Hardy) (Ready in April)

Peppermint. 20c. each; per doz., \$1.50; \$10.00 per 100.

Spearmint. 20c. each; per doz. \$1.50; \$10.00 per 100.

PARSLEY PLANTS (Ready in April)

Pot-grown. 10c. each; doz., \$1.00; \$7.00 per 100.

PEPPER PLANTS (Ready in May)

Bull Nose and Ruby King varieties only. Pot-grown plants. 10c. each; doz., \$1.00; \$7.00 per 100.

RHUBARB ROOTS

(Ready from October to May 15th)

Victoria. First Size Roots. 15c. each; \$1.50 per doz.; per 100, \$10.00. Allow 5c. each or 25c. per doz. for postage, if wanted by mail.

Victoria. Mammoth Roots for planting out, or suitable for forcing (not mailable). 35c. each; doz., \$3.50; \$6.25 for 25; per 100, \$22.50.

ROSEMARY (Perennial)

(Ready in April)

Pot-grown plants. 25c. each; doz., \$2.50; \$18.00 per 100.

SAGE (Hardy) (Ready in April)

Holt's Mammoth. Pot-grown plants. 20c. each; per doz., \$1.50; \$10.00 per 100.

SWEET POTATO PLANTS

(Ready in May)

Yellow and Red Nansemond. 75c. per 100; 1000, \$5.00. If wanted by mail, allow 15c. per 100 for postage. Not less than 100 plants can be furnished.

TARRAGON (Hardy) (Ready in April)

Hardy if given protection in winter. Pot-grown plants. 30c. each; doz., \$2.50; \$18.00 per 100.

THYME (Hardy) (Ready in April)

English Broad Leaved. This is almost an indispensable herb. 20c. each; doz., \$1.50; \$10.00 per 100.

TOMATO PLANTS

(Ready after April 15th)

Pot-Grown Plants in the following varieties only: Earliana, Stone, Dwarf Stone, Ponderosa, Crackerjack. 7c. each; doz., 75c.; \$5.00 per 100.

Hotbed Plants of Tomatoes, we have discontinued handling, they do not give general satisfaction, nor do they ship well.

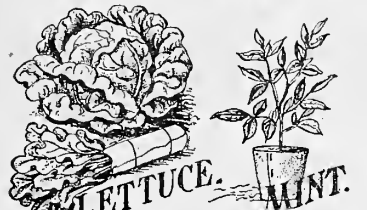

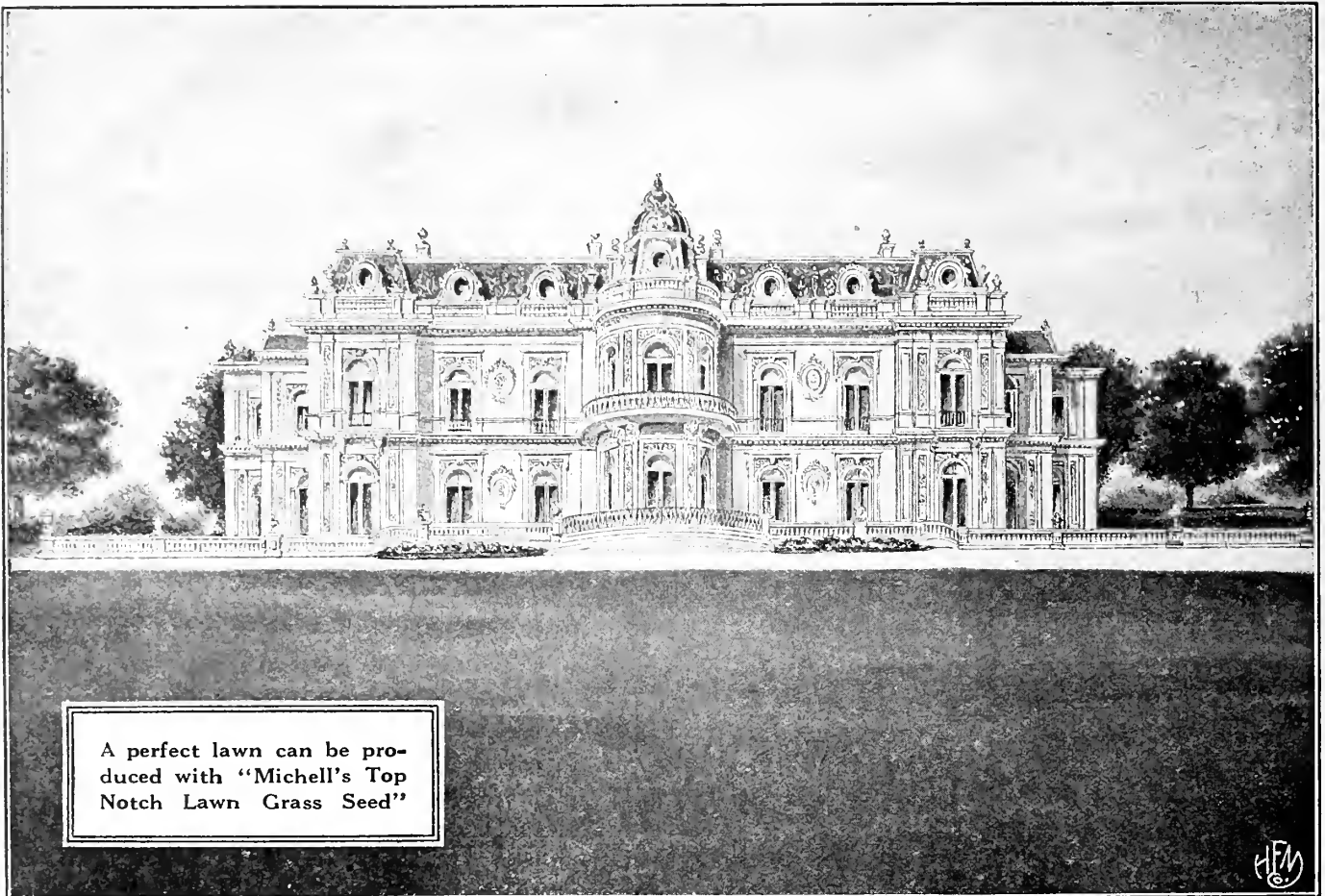

A perfect lawn can be produced with "Michell's Top Notch Lawn Grass Seed"

MICHELL'S RELIABLE GRASS SEEDS

All Prices subject to Market Changes

Our grass seeds are rigidly tested for purity and germination at the growing point, in the laboratories of the United States Department of Agriculture and by ourselves, and will be found of highest average. We make special formulas to suit various soils, climatic and local conditions. Our grass mixtures as sold have been based on many tests and on years of careful study; they are properly blended and will give splendid satisfaction.

Quantity to Sow for Lawns; you cannot sow too much, the more the better, it means a quicker, more satisfactory and more lasting results. From very exhaustive tests and experiments, we have found that in general too small a quantity has been recommended in the past; it requires sufficient seed to be sown if you want a quick permanent effect. On a small scale a quart will usually seed a space of 10 x 10 feet though twice that quantity is better; 6 to 8 or 10 bushels of 20 lbs. per bushel on new ground without grass, is the proper quantity per acre; 1 peck is needed for a space of 1000 square feet; $\frac{1}{2}$ bushel for a space 2000 square feet; 1 bushel for a space 4000 square feet or say 40 x 100 feet. For Putting Greens we advise 100 lbs. of seed for greens 100 x 100 feet. For Fairways, 8 to 10 bushels per acre. For Pasture and Hay Fields, 4 to 5 bushels per acre, based on a 20 pound bushel.

Michell's "Top Notch" Lawn Grass Seed. The top notch of quality. A perfectly blended combination of quick growing, very compact, fine bladed grasses that will produce a perfect lasting turf in a few weeks. 25 lbs. per bu. 25c. per pt.; qt., 45c.; 85c. for 2 qts.; 4 qts., \$1.50; \$2.75 per pk.; bu., \$10.00; 100 lbs., 37 $\frac{1}{2}$ c. per lb.

Michell's Green Velvet Lawn Grass Seed. The result of many years of untiring experimenting, and will produce a perfect turf; composed of close growing, fine leaved hardy grasses, which will stand wear and tear, and outlive the severest winter, retaining at all times its lustrous green color. 20 lbs. per bu. 20c. per pt.; qt., 35c.; 65c. for 2 qts.; 4 qts., \$1.25; \$2.25 per pk.; bu., \$8.00; 100 lbs., 37 $\frac{1}{2}$ c. per lb.

Michell's Evergreen Lawn Grass Seed. This is composed of the finest native and foreign short growing and fine bladed grasses, and will form a perfect turf. It weighs 20 lbs. per bushel, and every kernel is full of vitality. 15c. per pt.; qt., 30c.; 55c. for 2 qts.; 4 qts., \$1.00; \$1.75 per pk.; bu., \$6.50; 100 lbs., 30c. per lb.

Michell's Clover Lawn Grass Seed. The increasing demand for a grass seed mixture, containing a larger proportion of White Lawn Clover induced us to offer this brand; mixed with a liberal quantity of the best re-cleaned White Clover, which is peculiarly suited to take firm hold and grow quickly on hard or worn-out spots which sun burn easily. Splendid for seashore lawns. 30 lbs. per bu. 30c. per pt.; qt., 50c.; 90c. for 2 qts.; 4 qts., \$1.75; \$3.25 per pk.; bu., \$12.50; 100 lbs., 40c. per lb.

Michell's Seashore Lawn Grass Seed. If 3 or 4 inches of top soil is spread over the surface, and well firmed, an application of Michell's Special Formula Seashore Lawn Mixture will produce a good lawn in 6 to 8 weeks. An occasional application of pure Sheep Manure during the spring, summer and fall months will increase the strength and color of the grass. Our formula has been thoroughly tested out in various localities. If the soil is exceptionally poor, and it is not possible to apply a layer of top soil, white Clover will help to make the sod thick, and also protect the grass. 20 lbs. per bu. 20c. per pt.; qt., 35c.; 65c. per 2 qts.; 4 qts., \$1.25; \$2.25 per pk.; bu., \$8.00; 100 lbs., 37 $\frac{1}{2}$ c. per lb.

Michell's Shaded Lawn Grass Seed. Shaded locations have often been found difficult to keep in grass. We have combined a mixture of grasses that will produce a perfect sward in the most densely shaded place. It must be borne in mind that too much shade creates sour soil, and to guard against this apply air-slacked lime (or land plaster where the former is not available) at the rate of 1 bushel to each 1000 square feet. 20 lbs. per bu. 20c. per pt.; qt., 35c.; 65c. per 2 qts.; 4 qts., \$1.25; \$2.25 per pk.; bu., \$8.00; 100 lbs., 37 $\frac{1}{2}$ c. per lb.

Wizard Brand Sheep Manure

One of the most effective and satisfactory of all lawn fertilizers. See 3rd cover page.



MICHELL'S RELIABLE GRASS SEEDS

See Page 38 for recommendations for quantities required to sow an acre.

Fairmount Park Lawn Seed. A mixture meeting the requirements of those desiring a moderately priced grass seed. 20 lbs. per bu. Pt., 15c.; 25c. per qt.; 2 qts., 45c.; 75c. for 4 qts.; pk., \$1.50; \$5.50 per bu.; 100 lbs. at 25c. per lb.

Special Sod Grass Seed. A quick growing mixture, making a very tough and heavy sod in a short time; especially valuable for cemeteries, tennis courts, pleasure grounds, etc. 20 lbs. per bu. Pt., 15c.; 30c. per qt.; 2 qts., 55c.; \$1.00 for 4 qts.; pk., \$1.75; \$6.50 per bu.; 100 lbs. at 30c. per lb.

Michell's Terrace or Embankment Grass Seed. It is usually difficult to establish turf on steep inclines or on terraces. This mixture is composed of deep rooting varieties properly blended which will give very satisfactory results. 20 lbs. per bu. 20c. per pt.; qt., 35c.; 65c. for 2 qts.; 4 qts., \$1.25; \$2.25 per pk.; bu., \$8.00; 100 lbs. at 37½c. per lb.

Michell's Fair Ways (Golf Course) Mixture. This mixture is composed of short-growing, deep-rooted varieties that resist wear. It retains its color well during the severest droughts. Fairways to retain their permanency should receive additional sowings during the season to replace any weak or worn-out spots. 20 lbs. per bu. 15c. per pt.; qt., 30c.; 55c. for 2 qts.; 4 qts., \$1.00; \$1.75 per pk.; bu., \$6.50; 100 lbs. at 30c. per lb.

Southern States Evergreen Lawn Grass Seed. In the southern states especially below Virginia, it is extremely hard to establish a permanent lawn, if the proper combination of grasses are not used; after exhaustive tests and experiments we are pleased to state that our Southern States Evergreen Grass Seed Mixture will come up to the most sanguine expectations. Especially for dry, hot localities. 20 lbs. per bu. 15c. per pt.; qt., 30c.; 55c. for 2 qts.; 4 qts., \$1.00; \$1.75 pk.; bu., \$6.50; 100 lbs. at 30c. per lb.

Michell's Athletic Field Grass Seed. A special mixture of deep rooting, fine leaved grasses, especially suited for Baseball, Football and Cricket Grounds. Per qt., 30c.; 55c. per 2 qts.; 4 qts., \$1.00; \$1.75 per pk.; bu. (20 lbs.), \$6.50; 100 lb. lots and over 30c. per lb.

Michell's Tennis Court Grass Seed Mixture. Our mixture will be found particularly adapted for the purpose as grass is coming more into favor on tennis courts. 20 lbs. per bu. 20c. per pt.; qt., 35c.; 65c. for 2 qts.; 4 qts., \$1.25; \$2.25 per pk.; bu., \$8.00; 100 lbs. at 37½c. per lb.

Michell's Putting Greens Mixture. Our formula for this has been reached after many extensive tests, and those who desire to sow it will not be disappointed in the results they get from it. It is a quick-growing mixture of short, fine-bladed grasses. In sowing Putting Greens it is wise economy to be very liberal with the seed, as they are subjected to continuous hard use. We do not recommend less than 100 lbs. to a green, 100 feet square. 25 lbs. per bu. 35c. per pt.; qt., 65c.; \$1.25 for 2 qts.; 4 qts., \$2.25; \$4.00 per pk.; bu., \$15.00; 100 lbs. at 55c. per lb.

Michell's Teeing Grounds Mixture. Used on golf course tees or in other places where a tough resisting turf is wanted; makes a short, fine growth. 20 lbs. per bu. Pt., 20c.; 35c. per qt.; 2 qts., 65c.; \$1.25 per 4 qts.; pk., \$2.25; \$8.00 per bu.; 100 lbs. at 37½c. per lb.

White Clover. Choicest re-cleaned, for sowing on lawns, pastures, etc. Sow 10 to 12 lbs. per acre (60 lbs. per bu.). 5c. per pkt.; 10c. per oz.; ¼ lb., 25c.; 45c. per ½ lb.; lb., 85c.; \$4.00 per 5 lbs.; 10 lbs., \$7.75; \$45.00 per bu. of 60 lbs.; 100 lbs., \$75.00.

Last year we purchased some Putting Greens Grass Seed from your company which gave us excellent results. J. C. C.

Wayne, Mich.
The grass seed we sowed last year did all it was recommended to do and our lawn is the wonder of all who see it.
W. J. D.

Note.—All Grass Mixtures except Putting Greens, "Fair Greens" and Tennis Court Mixtures contain white clover. Any of them, however, can be furnished without this.



MICHELL'S PERMANENT PASTURE GRASS SEED

This mixture is a decided advantage over the usual timothy and clover seed formula, which at their best last usually two seasons. Our mixture of "Permanent Pasture" is a combination of hardy grasses, that will last for years, tho we advise re-sowing them lightly each season in spaces that are bare; attention like this will assure a continuous supply of nutritious pasture. Sow at the rate of 4 to 5 bushels (20 lbs. per bushel) on an acre of new land, or about $\frac{1}{2}$ that quantity for renovating. Prices. Pint, 15c.; 25c. per qt., 2 qts., 45c.; 85c. for 4 qts; peck, \$1.50; \$5.50 per bushel; 100 lbs., 25c. per lb.

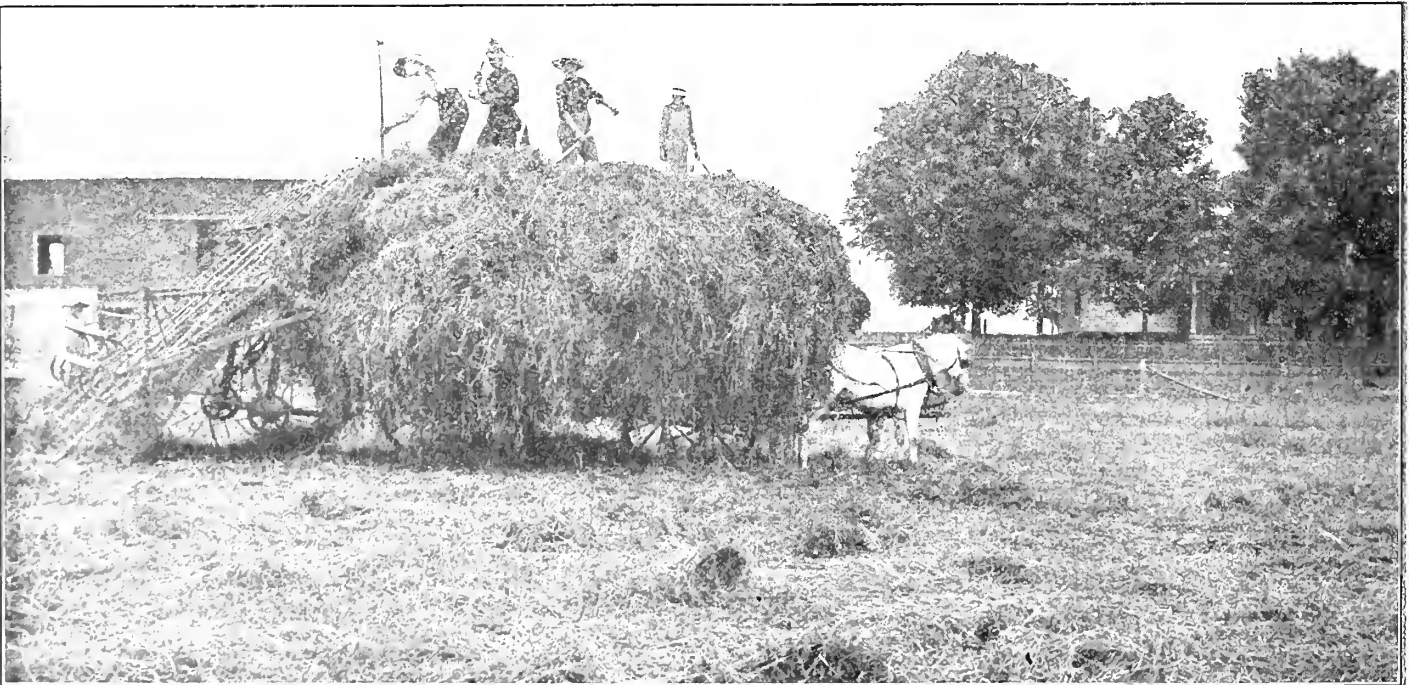

MICHELL'S PERMANENT HAYFIELD GRASS SEED

The old custom of depending upon hay seed sown with wheat is fast passing into the discard. Michell's Hayfield Mixture sown early in April will yield a crop of hay the same summer, while the old method requires waiting almost two years—a valuable lot of time lost. Our mixture is composed of a variety of high-grade, hardy grasses and clovers, one sowing of which will last a number of years. Sow at the rate of 4 to 5 bushels per acre (20 lbs. per bushel) on new land, or about $\frac{1}{2}$ that quantity for renovating. Prices. 15c. per pt.; qt., 25c.; 45c. for 2 qts.; 4 qts., 85c.; \$1.50 per peck; bushel, \$5.50; 100 lbs., 25c. per lb.

MICHELL'S GRASS SEEDS for Every Purpose

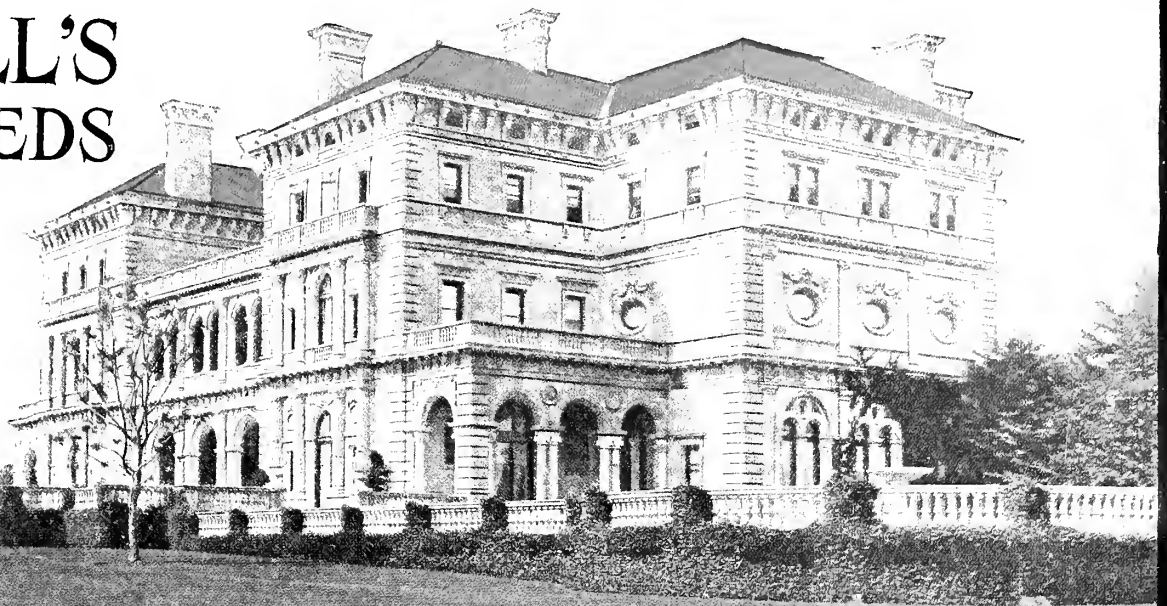

Michell's Green Velvet Grass Seed

is undoubtedly the best value at the price to be found anywhere. The formula is based on experience and tests and is being constantly improved where possible.

See body of Catalog for prices

Refer to index.

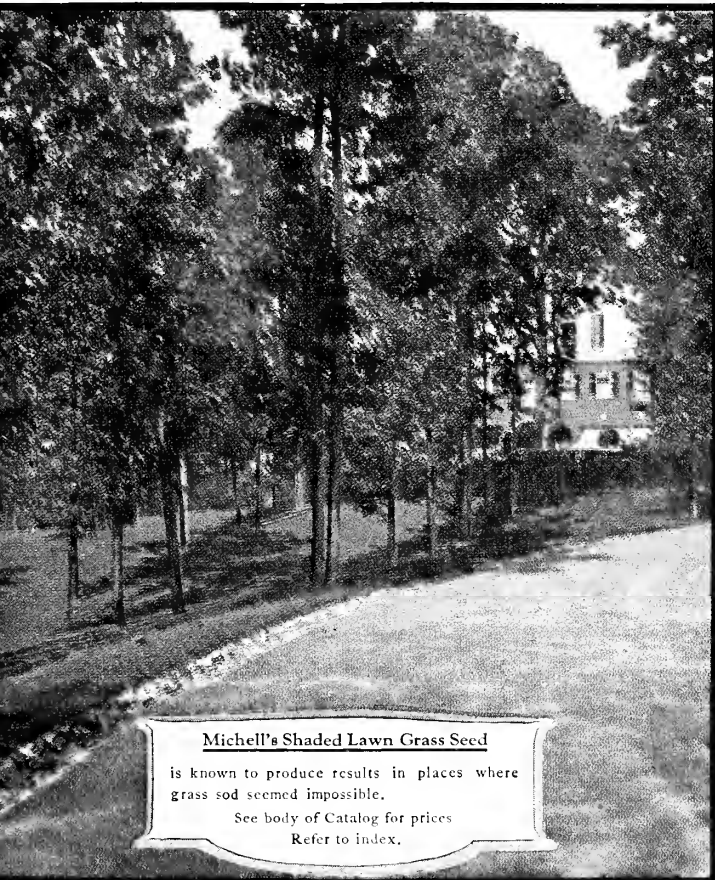

Michell's Shaded Lawn Grass Seed

is known to produce results in places where grass sod seemed impossible.

See body of Catalog for prices

Refer to index.

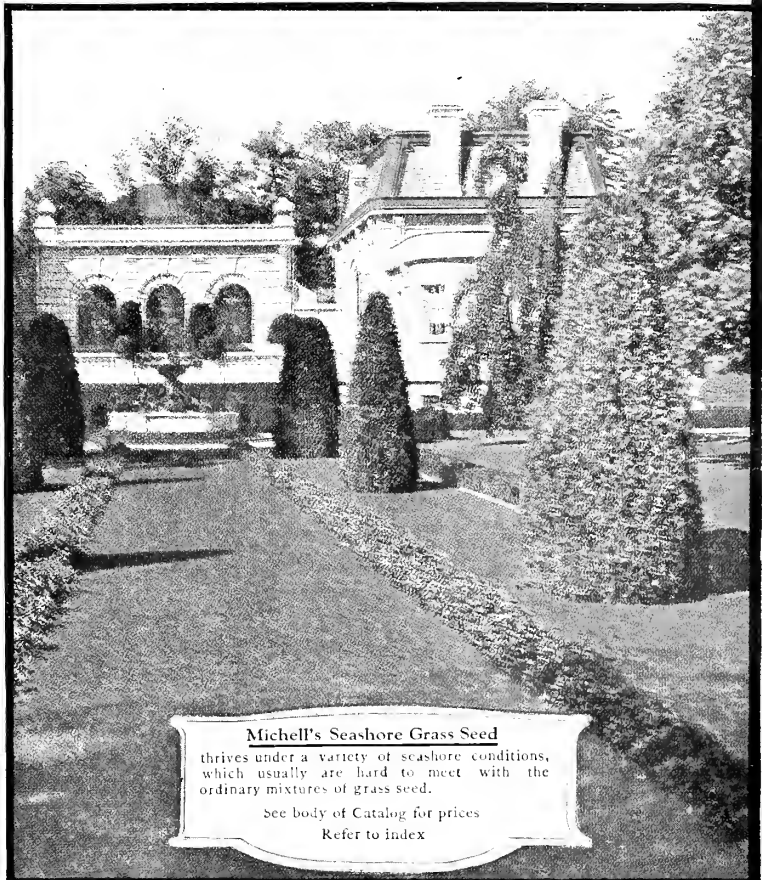

Michell's Seashore Grass Seed

thrives under a variety of seashore conditions, which usually are hard to meet with the ordinary mixtures of grass seed.

See body of Catalog for prices

Refer to index

WIZARD BRAND SHEEP MANURE A wonderful natural fertilizer; unequalled for the lawn.
Please see body of Catalog for prices; refer to index.



A Scene on the Famous "Pine Valley" Course

MICHELL'S GRASS SEEDS FOR GOLF COURSES

Golf today is perhaps responsible for the consumption of more grass seed than any other one field activity, and it is only natural that it is commanding the greatest attention. Creeping Bent, Red, Chewings, Creeping, or New Zealand Fescue; Fine Leaved Fescue, Kentucky Blue, Re-cleaned Red Top and Sheeps and Hard Fescue being most generally used either in mixture or separately. We are prepared to supply the very best qualities and shall be pleased to submit samples and quotations. Below is a partial list of the Golf Clubs we have been supplying and we freely refer any prospective customer to these.

MICHELL'S GRASS SEEDS

are used on the grounds of the following Golf and Country Clubs:

Albenarle Golf Club, Va.	Ft. Wayne Country Club, Ind.	Philmont Country Club, Pa.
Altoona Cricket Club, Pa.	Fountain Springs Country Club, Pa.	Phoenixville Country Club, Pa.
Aronimink Country Club, Pa.	Frankford Country Club, Phila.	Pine Valley Golf Club, N. J.
Arundel Golf Club, Me.	Germantown Cricket Club, Pa.	Plymouth Country Club, Pa.
Bala Country Club, Pa.	Green Valley Country Club, Pa.	Point Pleasant Golf Club, N. J.
Belfield Country Club, Pa.	Grosse Ile Golf Club, Mich.	Reading Country Club, Pa.
Bethesda Country Club, Md.	Gulph Mills Golf Club, Pa.	Riverton Country Club, N. J.
Bloomfield Hills Country Club, Ill.	Hotel College Arms, Fla.	Roxborough Country Club, Pa.
Blue Ridge Country Club, Pa.	Huntingdon Valley Country Club, Pa.	St. Davids Golf Club, Pa.
Boulder Country Club, Colo.	Indiana Country Club, Pa.	St. Louis Country Club, Mo.
Buck Hill Falls Golf Club, Pa.	Inverness Golf Club, Ohio.	Sea View Golf Club, N. J.
Bucks Co. Country Club, Pa.	Lansdowne Country Club, Pa.	Springhaven Club, Pa.
Cape May Golf Club, N. J.	Lancaster Country Club, Pa.	Spring Lake Golf Club, N. J.
Cedar Brook Country Club, Pa.	Lehigh Country Club, Pa.	Stafford Country Club, N. Y.
Chambersburg Golf Club, Pa.	Llanerch Country Club, Pa.	Stenton Country Club, Pa.
Chetremont Country Club, Pa.	Lulu Temple Country Club, Pa.	Sunnybrook Golf Club, Pa.
Chevy Chase Club, Md.	Mercer Country Club, W. Va.	Tavistock Country Club, N. J.
Cohanzie Country Club, N. J.	Merchantville Country Club, N. J.	Torresdale Golf Club, Pa.
Columbia Golf Club, Md.	Merion Cricket Club, Pa.	Tredyffrin Country Club, Pa.
Country Club of Atlantic City, N. J.	Moorestown Country Club, N. J.	Washington Country Club, D. C.
Country Club of Cleveland, Ohio.	New Castle Field Club, Pa.	White Marsh Valley Country Club, Pa.
Country Club of Harrisburg, Pa.	Northampton Field Club, Pa.	Wilmington Country Club, Del.
Country Club of Lakewood, N. J.	North Hills Golf Club, Pa.	Westbrook Country Club, Ohio.
Country Club of Virginia, Va.	North Jersey Country Club, N. J.	West Chester Biltmore Co. Club, N. Y.
Dayton Country Club, Ohio.	Oak Ridge Country Club, N. Y.	West Chester Golf Club, Pa.
Deal Golf Club, N. J.	Old York Road Country Club, Pa.	Westmoreland Country Club, Ill.
Denver Country Club, Colo.	Onondaga Golf and Country Club, N. Y.	Westwood Country Club, Ohio.
Detroit Golf Club, Mich.	Opequon Golf Club, W. Va.	Woodbury Country Club, N. J.
Doylestown Country Club, Pa.	Overbrook Golf Club, Pa.	Wykagyl Country Club, N. Y.
Eagle Nest Country Club, N. Y.	Penns Grove Golf Club, N. J.	Wyoming Valley Country Club, Pa.
Eaglesmere Golf Club, Pa.	Philadelphia Country Club, Pa.	Yahnundasis Golf Club, N. Y.
Fairmount Park Course, Pa.	Philadelphia Cricket Club, Pa.	And Many Others.
	Philipsburg Country Club, Pa.	



A VIEW OF HOTEL CAPE MAY AT CAPE MAY, N. J.

MICHELL'S SEASHORE LAWN GRASS SEED

MICHELL'S RELIABLE GRASS SEEDS

Bermuda Grass. For sowing as far North as Washington, D. C., above which latitude it is not hardy (35 lbs. per bu.).

Blue Grass. Fancy Kentucky (*Poa Pratensis*). Our stock of this is extra fine, thoroughly re-cleaned; sow 5 to 6 bu. per acre on lawns, 4 to 5 bu. on pasture fields (14 lbs. per bu.).

Blue Grass, Canadian (*Poa Compressa*). Makes an ideal pasture, highly relished by cattle; excellent also for sowing on embankments; sow in same proportions as Kentucky Blue Grass Seed (14 lbs. per bu.).

Chewing's Fescue. See Red Creeping or New Zealand Fescue (14 lbs., per bu.).

Creeping Bent (*Agrostis Stolonifera*). Adapted admirably for lawns, also putting greens, tennis courts, etc.; sow 100 lbs. on a putting green 100 ft. square (20 lbs. per bu.).

Creeping Fescue. Another name for New Zealand, Red or Chewing's Fescue (14 lbs. per bu.).

Crested Dogtail (*Cynosurus Cristatus*). Excellent as a pasture and lawn grass. Sow 4 to 5 bu. per acre (21 lbs. per bu.).

English or Perennial Rye Grass (*Lolium Perenne*). (*Pacey's Fancy Short Seeded*.) This makes the quickest returns in growth of any grass; is deep rooted and is readily established. Sow 5 bu. per acre (24 lbs. per bu.).

Fine Leaved or Slender Fescue (*Festuca Tenusifolia*). This grass is especially valuable for dry soils. Sow 5 to 6 bu. per acre (14 lbs. per bu.). Price on application.

Hard Fescue (*Festuca Duriuscula*). A splendid grass for golf links, tennis courts, etc.; will resist droughts. Sow 6 to 7 bu. per acre (12 lbs. per bu.).

Herd or Red Top, Fancy Re-cleaned. This is one of the best grasses for sowing for immediate effect. Our stock is free from chaff and is absolutely pure. Sow 35 lbs. per acre (32 lbs. per bu.).

Herd or Red Top, Unhulled (*Agrostis Vulgaris*). Sow 6 to 8 bu. per acre on lawns, or 5 to 6 bu. on pasture lands (10 lbs. per bu.).

Italian Rye (*Lolium Italicum*). Very desirable for pasture; it comes to maturity the first season; the ideal seed for southern lawns in winter. Sow 100 lbs. per acre (18 lbs. per bu.).

Meadow Fescue (*Festuca Pratensis*). Sow 100 lbs. per acre (22 lbs. per bu.).

New Zealand Fescue. See Red Creeping or Chewing's Fescue. (14 lbs. per bu.).

Orchard Grass (*Dactylis Glomerata*). For early pasturing this is very desirable; also fine for sowing in shaded places. Sow 50 lbs. per acre (14 lbs. per bu.).

Red or Creeping Fescue (*Festuca Rubra*). Very valuable for sowing on sandy soil and in shaded places, also on putting greens. (14 lbs. per bu.). Sow 100 to 125 lbs. per green 100 ft. square.

Rhode Island Bent. For sowing at seashore resorts, on putting greens, tennis courts, etc.; sow 100 lbs. on a putting green, 100 ft. square.

Rough Stalked Meadow (*Poa Trivialis*). A splendid shade grass, and valuable for use in golf course turf formation. Sow at the rate of 100 lbs. per acre.

Sheep's Fescue (*Festuca Ovina*). This makes an excellent grass for sowing on lawns, fields or pleasure grounds. Sow 6 to 7 bu. per acre (12 lbs. per bu.).

Sweet Vernal (*Annual*). For sowing among grass to impart a sweet odor which is evident at mowing time. 5 lbs. per acre.

Sweet Vernal (*Perennial*). 5 lbs. per acre.

Sudan Grass Seed (*Annual*). This belongs to the forage crops and is allied to the millets. See page 49. Sow 16 to 24 lbs. per acre. Price on application.

Timothy (*Phleum Pratense*). Sow one-half bu. per acre alone (45 lbs. per bu.). Price varies constantly; ask for quotations.

Wood Meadow (*Poa Nemoralis*). The best grass for sowing under trees where a lawn is desired. Sow 75 to 100 lbs. per acre (14 lbs. per bu.).

WHITE DUTCH LAWN CLOVER

Splendid for sowing among grass on lawns and other places where a thick, quick growth is desired; especially adapted for seashore lawns. Prices: 5c. per pkt.; oz., 10c.; 25c. per ¼ lb.; ½ lb., 45c.; 85c. per lb.; 5 lbs., \$4.00; \$7.75 for 10 lbs.; per bu., \$45.00; \$75.00 per 100 lbs.

42 NITROGEN-GATHERING BACTERIA THE WONDERFUL FERTILIZER FOR LEGUMINOUS CROPS



Inoculate Your
Alfalfa, Clovers, Cow Peas, Soy Beans, Vetches
and
Other Legume Crops
WITH
Mulford Cultures
FOR LEGUMES

Small Cost Large Returns Easy to Use No Labor Expense



The most Fertilizer Value of Legumes depends largely upon Inoculation with these Bacteria. 1000 to 2000 pounds of Nitrates to the acre can be deposited in little sacks or nodules on the roots of the legumes, which will be immediately available for any following crop. Legumes embrace all of the various types of clovers, peas, beans and such other plants that have blossoms similar in shape and form to the above named. This type of plant has the ability of taking from the air vast quantities of free nitrogen, which exists there, and which is not absorbed by other plants than those which belong to the legume family. This nitrogen is taken (breathed so to say) through the stems of the plant and deposited at the roots in little sacks or nodules, where it becomes immediately available as plant food in the form of nitrates. The application of bacteria to the seed of these legumes when planting practically trebles the nitrogen-gathering power, and for this reason we urge all planters to use it on all such occasions. Please note that the bacteria is not applicable to any other class of plant through inoculation, except as noted; succeeding crops, though, following on ground where bacteria was used,

derive tremendous benefits, as many plants that are not legumes require quantities of nitrates as plant food.

Mulford Cultures are prepared for

ALFALFA	BURR CLOVER	VELVET BEANS
CRIMSON CLOVER	COW PEAS	SWEET PEAS
SWEET CLOVER	SOY BEANS	GARDEN PEAS
RED CLOVER	PEANUTS	STRING BEANS
ALSIKE CLOVER	VETCH	LIMA BEANS
JAPAN CLOVER		

Always specify on your order what crop you want to inoculate, as there is a different strain of bacteria for each legume.

PRICES OF MULFORD CULTURES

5-Acre Size (A Dollar per Acre).....	\$5.00	1-Acre Size.....	\$1.50
		1/4-Acre Size.....	.75
Trial Size (supplied only for Garden Peas, Garden Beans, Lima Beans and Sweet Peas).....			.35

STANDARD INOCULATING BACTERIA



Manufactured by a reputable concern, and from inquiries we have made, persons who have used same are enthusiastic in their endorsement of Standard Bacteria. Prepared for Alfalfa, Soy Beans, Cow Peas, Sweet Clover, Red Clover, Crimson Clover, Alsike Clover, Vetch, Field Peas, Garden Peas, Sweet Peas, Field Beans, Peanuts, Garden Beans, and all other legumes.

Prices. Trial Size (supplied only for Garden Beans, Garden Peas and Sweet Peas) 25c.; Garden Size, 50c.; 1-Acre Size, 75c.; 2-Acre Size, \$1.45; 4-Acre Size, \$2.25; 6-Acre Size, \$3.00. Sent postpaid on receipt of price.

ALPHANO INOCULANT

This comes in a finely powdered form, making it easy to use. An ideal material for the bacteria's breeding and living place. They retain their vitality for a long period and under conditions utterly impossible with other carrying substances used.

In addition to its distinct advantage of double nitrogen action in the soil, and that it contains all the essential legume bacteria in one package, and that you need never have but the one kind to meet all your inoculation needs, there is also its remarkably low price.

Alphano Inoculant, the makers claim, serves as a bacteria for all crops, the reverse of statements by other makers of bacteria. The reason, however, may lie in the fact that it is a soil or humus bacteria, while others are manufactured cultures. The Alphano Humus Company, who make this, have been experimenting with it and testing it out for several years in the agricultural departments of various experimenting stations, with results highly satisfactory, a special circular on Alphano Inoculant may be had free on request. Prices—1-Acre Size (net weight of can, 2 lbs.), \$1.00; 10-Acre Size (net weight, 20 lbs.) \$8.00; (postage extra).

Farmogerm A Seed Inoculant that Increases Crop Production.

Farmogerm Stays Good Indefinitely. Farmogerm keeps for years, because of the method of sealing the bottle—a patented stopper which admits filtered air and keeps out all impurities. Farmogerm always has its full strength. Just add water and shake the bottle and sprinkle over the seeds as directed.

The makers claim no other inoculant on the market is so strong and virile; no other inoculant will thoroughly treat as much seed. The one-acre size bottle of Farmogerm is sufficient for 15 pounds of clover, 20 pounds of alfalfa, 100 pounds of Canada Field Peas, 60 pounds of Vetch, etc. A different bacteria is required for each crop. When ordering, be sure to state what crops you wish to inoculate.

A special culture is prepared for Peas, Beans and Sweet Peas—1/4-acre size only. Ask for No. 5, price, 50c.

Farmogerm prices are: 1-Acre Size, \$1.00; 3-Acre Size, \$2.50; 12-Acre Size, \$9.00. Full directions accompany each bottle.

Humogerm A Humus inoculated with bacteria, applied by mixing and sowing or planting with the legume to be treated. Be sure and specify for what crop it is desired. This material is sown on the bushel seed basis. 1/4 bu. seed size, 35c.; 1/2 bu. seed size, 60c.; 1 bu. seed size, \$1.00; 2 1/2 bu. seed size, \$2.25. Special size for garden use, for Peas, Beans and Sweet Peas, 25c. If Humogerm is wanted by P. P. allow 10% for mailing.



Our Strains of Red Clover are unusually fine

Alfalfa or Lucerne (*Medicago-Sativa*). The most valuable forage crop on the American farm today, and can be truly termed a mortgage lifter. It is sown during May, August and September, these being the best months for success, although it can be sown at other times with a possible chance of doing well. Careful preparation of the soil previous to sowing is the main thing. Our special Circular on Alfalfa explains this fully, and is free for the asking. Sow not less than $\frac{1}{2}$ bushel (30 lbs.) per acre, preferably with no other crop. Our seed is always over 99 per cent pure, and will invariably give the best of results. **Choice Non-Irrigated Western Grown Seed.** Price on application.

Grimm Alfalfa. Claimed to be hardy in any and all regions, a heavy yielder and of deep rooting ability. Highly recommended by various State Experiment Stations. Requires about 10 lbs. of Grimm Alfalfa to properly seed an acre, on account of its great root system and spreading habit. Price on application.

Alsike or Swedish Clover (*Trifolium Hybridum*). One of the best for mixing with timothy; it is perfectly hardy in every climate or soil condition and seldom has to be reseeded. Under ordinary conditions it grows from 1 to 2 feet high; it is sown early in the spring or late summer and early autumn. It is as nutritious as red clover and is rapidly coming to the front as a valuable farm crop. Flower resembles white clover except head is larger and has a red tinge on the edge. Sow 10 to 15 lbs. per acre alone, or 3 lbs. per acre with timothy. Price on application.

Bokhara or Sweet Clover (*Melilotus Alba*). While extensively used as a bee food, this is a valuable variety for soiling (green manure); for sowing in spring on lands which are later to be sown in Alfalfa, this is excellent. It inoculates the ground and seems to render it more capable of insuring a good stand of Alfalfa than if it is not used. It grows from 3 to 5 feet high, according to soil and location; can be cut as often as three times in a season if wanted for forage. Sow 15 lbs. per acre in early spring, alone, or 10 lbs. per acre with other crops. We handle only the true white flowering hardy variety. **Choice Hulled Seed.** Price on application.

Crimson Clover (*Trifolium Incarnatum*). This is used principally for soiling or green manuring, for which purposes it is highly valuable. If desired for feed, cut it just before it flowers. When desired for green manure, it should be allowed to mature; its height is from 1 to 2 feet. Sow any time from April to October, the earlier the better, 20 lbs. to the acre. If sown in early spring it can be plowed down the first year. Late summer or fall seeding is usually practiced. It is not hardy for more than one season and must be sown each year. Price on application.

Mammoth Red Clover (*Trifolium Pratense Perenne*). Sometimes called Sapling or Pea Vine Clover and English Cow Grass. This differs from the "Medium," being of a ranker growth and yielding more fodder per acre. It ripens somewhat later and is more hardy, lasting several seasons longer than the medium red clover. It also does well on poorer soils. The seed cannot be distinguished from the former. Our supply, however, is strictly reliable. Sow in early spring or in July and August, using 20 lbs. per acre alone, or with other crops 10 lbs. per acre; flowers pink. It can be cut several times in a season. Price on application.

Red Clover, Medium (*Trifolium Pratense*). More widely known and used than any other; used principally for hay purposes. Height from 18 inches to 2 $\frac{1}{2}$ feet. Sow early in the spring or in late summer—July and August; if alone, 20 lbs. per acre; if with other crops, 10 lbs. per acre. A red clover field can be cut twice a season. It is usually resown every third season; flowers pink. Price on application.

SWEET CLOVER (Hubam)

A new strain of Annual White Flowering Clover.

This is the wonderful new clover that has caused such a sensation throughout the country. It does in one year all that other clovers do in two years. It reaches three to seven feet in height in from four to seven months after sowing. It has grown successfully in every state and in most foreign countries. It is the greatest fertilizing plant known, a wonderful hay and pasture crop, and unsurpassed as a honey producer.

At Iowa Experiment Station, after the harvesting of a small grain crop, it produced six times the growth of medium red clover and Mammoth clover, when seeded with the small grain. The drought resistant qualities of this clover are remarkable; without irrigation and with less than one inch rainfall after seeding it has made a growth of seven feet. Hubam seed have been sent out for trial and it has succeeded in every state and many foreign countries. Its value to agriculture cannot be measured.

Hubam was discovered by Prof. Hughes of Iowa Agricultural Experiment Station in 1916.

Hubam Clover (Annual White Sweet Clover) is the most wonderful fertilizer, hay, pasture and honey clover known. Sow 12 pounds per acre broadcast or 3 pounds in cultivated rows very early in the spring.

Hubam adds nitrogen and humus to the soil, makes splendid summer and fall pasture, is a rich hay crop, and a **wonderful honey producing plant.** Hubam produces the choicest white honey and lots of it. It begins blooming in from 2 to 4 months from seeding and continues for several months.

Hubam should be harvested when about one-half of the seed pods have turned brown and the first ripe seed is beginning to shatter on the ground.

Hubam will stand a quite strong alkali soil: it loves the strong lime soils. When soils are distinctly acid a liberal application of lime should be made.

Hubam will not benefit the soils upon which it grows without inoculation. Proper inoculation is always present in the soil upon which sweet clover or alfalfa has been grown. Artificial inoculation can be supplied by treating the seed with any of the commercial cultures or working soil from a sweet clover or alfalfa seed bed into the soil where the Hubam is to be grown. Strong virile cultures have often proven of advantage even where the soil has been known to have been previously inoculated.

It is necessary to scarify Hubam seed in order to get satisfactory germination. Unscarified seed will often not germinate over 25% while the same seed well scarified will germinate as high as 90%. **Never sow unscarified Hubam Seed.**

Order now as there is a large demand for this seed and you may be disappointed if you delay.

Price for Genuine Hubam Sweet Clover, subject to change, (scarified seed). Per lb., 50c.; \$2.40 for 5 lbs.; 10 lbs., \$4.50; \$10.00 for 25 lbs.; 100 lbs., \$37.50.

White Dutch or Lawn Clover (*Trifolium Repens*). This is valuable for pasturage as well as for lawns; it succeeds where other clovers and grasses fail, and it seldom dies out. It can be sown at all seasons, although early spring is best; flowers greenish white. Sow 10 to 12 lbs. per acre if alone, or 5 lbs. if sown on old turf or with other crops. 5c. per pkt.; oz., 10c.; 25c. per $\frac{1}{4}$ lb.; $\frac{1}{2}$ lb., 45c.; 5c. per lb.; 5 lbs., \$4.00; \$7.75 per 10 lbs.; per bu. of 60 lbs., \$45.00; \$75.00 per 100 lbs. Prices on White Clover subject to change.

44 MICHELL'S SELECTED HAND PICKED FIELD CORN

Plant 8 to 10 qts. per acre in hills for shelled corn or for silo, or sow 1½ to 2 bushels broadcast for fodder

Our strains of corn are not the common kinds usually found in abundance on the market; we pay as much attention to carefully selected stocks in all lines of farm seeds as we do the critical vegetable and flower seed part of the business. This is particularly true of field corn where re-selection means the limit of crop with little or no increase in cost. It is amazing to realize where the old unselected seed is used, the average crop per acre is only half compared to the more intelligent selection of strains. Our stock is selected for size of ear and fodder, uniformity of kernel and the careful finish of the tip and butt, all of which means a considerable increase in production.

A NEW FIELD CORN Mellinger's Golden Queen

A high yielding variety of yellow dent noted for heavy production of both grain and silage. It has given the highest average yields in 23 variety tests conducted during five consecutive years by the Delaware County (Pa.) Farm Bureau, proving superior to the better known varieties. A hardy, resistant corn, producing a good ear on every stalk, with few nubbins. Ears large, showy; rows straight; butts and tips well filled. Grains square cut, moderate in depth, with uniform, dimpled dent easily distinguishing it from other varieties. Fodder heavy and leafy, 10 to 12 ft. tall, averaging 12 to 14 tons of silage per acre. On fertile soil capable of yielding 90 bushels shelled corn or 20 tons silage. Season two or three days shorter than Cloud's Yellow Dent. Our seed has been especially grown for seed purposes and carefully selected to type.

Price, subject to change, 25c. per qt.; 4 qts., 90c.; \$1.50 per peck; per bushel, \$5.00.

Champion White Pearl. An immense yielder, maturing in about 115 days; kernels deep set and snowy white; the merits of this corn are surprising.

Cloud's Early Yellow Dent. Our stock of this is grown on especially prepared ground. Every grain is uniform and perfect. Though the fodder grows often 10 feet high, the crop is matured in 100 days. The ear is about 10 inches long with a very thin cob when shelled, while the canary yellow grains are about ¾ of an inch long. It delights in rich soil if the best is expected of it.

Drought Proof. Long, yellow grain, produced on long thin cobs; matures in 90 to 100 days, and yields well under trying weather conditions.

Early Canada Flint (Eight Rowed). A medium broad grained variety, perfectly smooth on the end and very hard. Makes a desirable sort for late planting. The cobs are very thin when shelled; excellent for pigeon and poultry feed.

Eureka Yellow Dent (Ensilage). Light canary yellow; deep grained; fine ear and fodder.

Golden Beauty. The broad, massive golden yellow dented grains are arranged very evenly on gigantic ears. Fodder is enormous, often growing 12 feet high; matures late, but yields wonderful crops; desirable for silo and ensilage purposes.

Leaming Early Dent. This variety has always been used foremost by most planters of field corn in the locality of Philadelphia. Beautiful long ears of deep grained, uniform kernels. The cob when shelled is very small. The stalks grow about 7 feet high, very leafy, excellent for fodder, and on the average will produce two ears to the stalk; ripens in 90 days and occasionally crops 100 bushels to the acre. Every grain is uniform and perfect.

Reid's Yellow Dent. A splendid late variety with an average record of 100 bushels per acre; small cob, deep bright yellow grain.

Red Cob Ensilage. A long, narrow, white grain; a late maturer, and used for silo, green feed or ensilage purposes. A tall, rank grower and prolific in leaves.

Silver King. A pure white dent corn, ripening in 100 to 105 days, ears averaging 8 to 9 inches long, grains closely set and straight in the row. The ears grow a uniform size.

White Cap Yellow Dent. A large eared variety with hard, large grain, quite deep; matures in about 100 days. The grain is light yellow, with a white end or face.

Price on Field Corn (where not quoted) upon application.

2 Bu. Seamless Bags used in shipping field Corn are chargeable at 40c. each, but are returnable for credit.

STANLEY'S CROW REPELLANT

It rids your Corn Crop of Crows and other corn pulling birds, and animal pests, such as Moles, Gophers, Woodchucks, Prairie Dogs, Squirrels, etc. Saves loss of seed and labor of replanting. Positively will not clog any planter. Aids and hastens germination of seed corn. Protects seed from rotting in the ground. Insures larger yields per acre. Is non-poisonous and will not injure the seed. Will not kill birds or animals, but will keep them away and prevent destruction by them. Has been used successfully by experienced corn growers for over ten years. Large can, enough for two bushels of seed corn, \$1.50; small can, enough for one bushel, \$1.00.

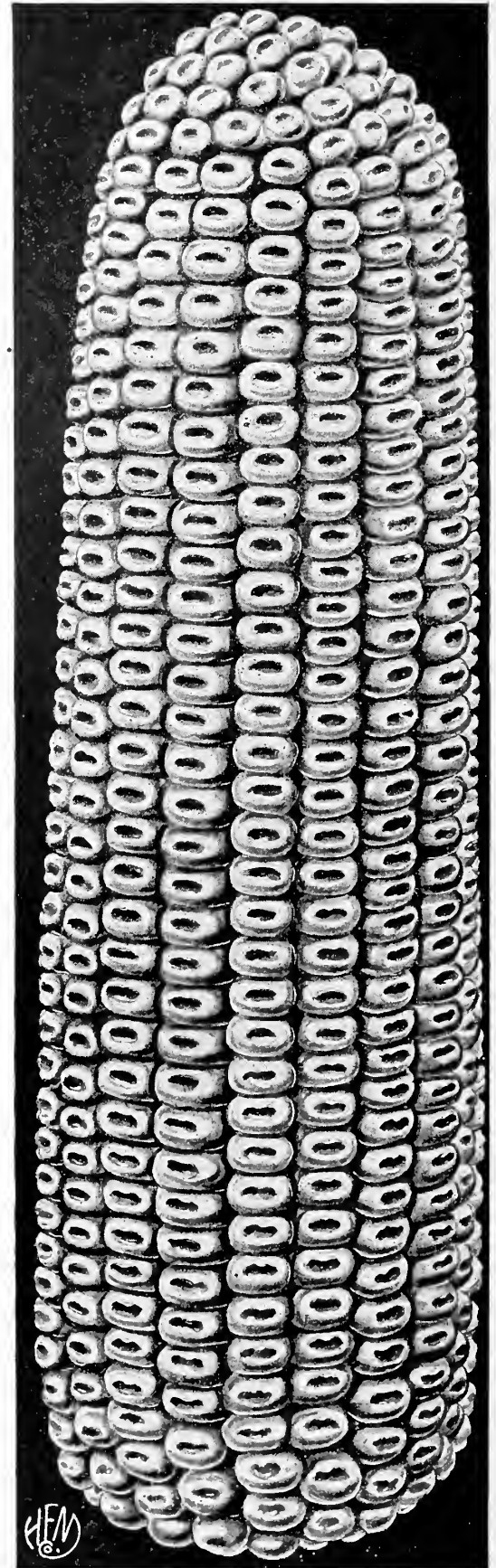

Mellinger's Golden Queen Corn

For Corn Planters see Page 147.

ALL PRICES SUBJECT TO MARKET CHANGES

(ow)

ALFALFA (See page 43)

BARLEY

The straw is good for green feed or when cured, as hay. The grain in the hull is excellent poultry feed. If wanted for hay it should be cut while the grain-head is in a soft or milky condition. Sow broadcast $1\frac{1}{2}$ to 2 bushels per acre from May 15th to July 1st. 48 lbs. per bushel.

Barley makes an ideal nurse crop for spring sown Alfalfa. When sown in connection with alfalfa, use $\frac{1}{2}$ to $\frac{3}{4}$ bushel per acre broadcast; when ripe, harvest as usual or cut and rake off.

Beardless. New York grown stock; frequently yields 50 bushel per acre. Price on application.

Note.—While offered as beardless, barley has the fault of reverting back to its type which is bearded, so that some bearded heads will invariably appear in the field.

BEANS, SOJA OR SOY

This very valuable farm plant enriches the ground in which it is planted by the free nitrogen gathered from the air, and which is deposited in the ground by the roots, leaving it in ideal condition, and rich in nitrogen for the next crop. Fodder is relished in either green or dry form by cattle and dairy cows. Excellent to combine as feed with hay or corn. The seed when harvested and ground into meal is fed with great advantage to milch cows, mixed with bran or any soft feed; it gives the milk a very rich flavor. Sow $1\frac{1}{2}$ bushels per acre alone, or $\frac{1}{2}$ bushel Soja Beans with one bushel Cow Peas. Sow in drills $2\frac{1}{2}$ feet apart, any time from the first to the last of May. If wanted for silo it will be ready for harvest about the first of September, when the pods will be well filled; yields as high as 20 tons of green food per acre. 60 lbs. per bushel.

Mammoth Yellow (Late). **Wilson (Early).** Price on application.



Beardless Barley



Japanese Buckwheat

BUCKWHEAT, Japanese

In the locality of Philadelphia this is sown any time from June 1st to July 15th, one bushel of 48 lbs. broadcasted to the acre. If one has the ground prepared and the opportunity, it can be sown as early as May 1st. It makes a very fine quality of flour, but is largely used for poultry food. For planting adjacent to game preserves it provides excellent food for the birds. The flower makes ideal bee food, while the straw is very abundant. Our seed is grown by a specialist in New York State. Any of the clover crops can be sown with buckwheat, these to mature the following season. Buckwheat frequently yields as much as 80 bushels to the acre. Price upon application.

CARROT

These should form a staple crop on every farm, as they can be successfully used in feeding horses, cows, poultry, sheep, and pigs; every farmer should sow a quantity of them for winter use. They are easily grown, are little trouble to harvest, store and keep. On page 13 we offer a long list but for farm purposes the two varieties below are best, being the largest yielders; sow 3 to 4 lbs. per acre.

	Oz.	$\frac{1}{4}$ lb.	Lb.	5 lb.
Danvers Half Long	\$0.15	\$0.50	\$1.50	\$6.25
Long Orange	.15	.50	1.50	6.25
White Belgian	.15	.30	1.00	4.25

CORN, WHITE KAFFIR, for Seed

(See Illustration on page 46.)

The grain is used for feeding poultry and the fodder for cattle. Grows from 4 to 6 feet high, the grain being produced on the top of stalk in the shape of a brush; frequently as many as four heads of grain will be found on a single stalk. It usually ripens after the first few frosts; produces enormous crops. Can be sown as late as July at the rate of 10 lbs. per acre in drills. (Bu. 56 lbs.) Price on application.

FARM SEED PRICES

Because of the constant fluctuation, we have not quoted them in this catalog but will gladly do so upon information as to quantity wanted.



Mammoth Yellow Soja Beans

2 Bu. Seamless Bags required in shipping Farm Seeds are chargeable at 40c. each, but are returnable for credit.

MICHELL'S HIGH GRADE FARM SEEDS



For description and offering of Kaffir Corn see page 45.

BROOM CORN

The chief value of this plant lies in the top or brush, as it may be called, which is made into brooms. The fodder grows to a height of about nine feet, and is suitable for bedding. Sow in May, about ten pounds per acre, in drills 3 feet apart. Plants should be thinned out to stand 3 inches apart in the row.

Evergreen. This sort produces extremely straight brush, retaining its green color well after ripening, thus commanding the highest market prices. Yields 1000 lbs. of salable brush per acre. Bushel, 50 lbs. Price on application.

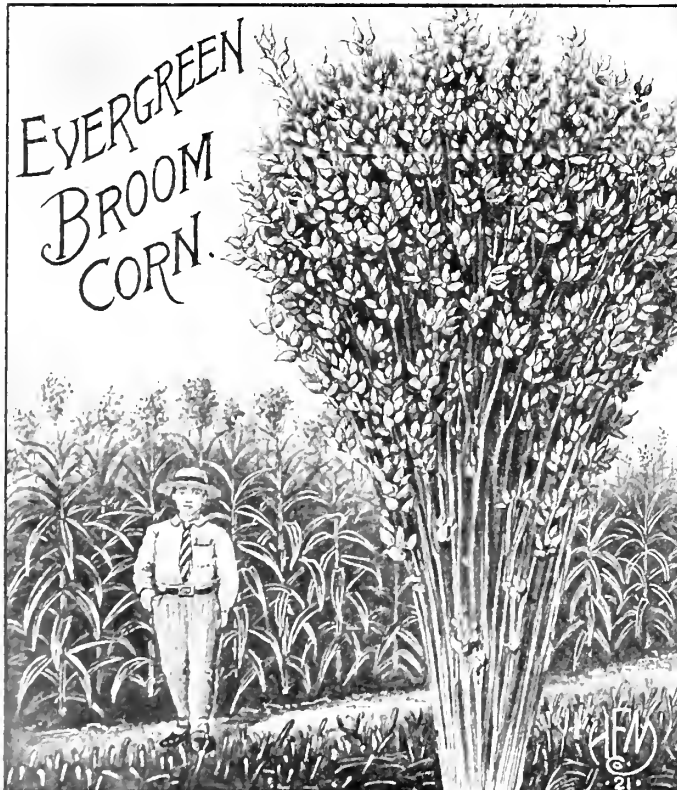

CATTLE BEET, Mangel-Wurzel. See Page 25.

CLOVER SEED. See Page 43.

COTTON SEED

Sea Island If sown early in May, will mature in the latitude of Philadelphia. 15c. per $\frac{1}{4}$ lb.; lb., 40c.; \$1.25 for 5 lbs.

FLAX

This is grown for the fibre from which linen thread is made and also for the seed from which that indispensable product, "Linseed Oil," is made. When ground it makes an excellent tonic when fed to horses, cattle and poultry. If sown to harvest seed, plant 1 bushel to the acre from May 15th to June 15th. If desired for the fibre, sow $1\frac{1}{2}$ to 2 bushels (bushel, 56 lbs.). Price on application.

GRASS SEEDS. See Pages 38 to 41

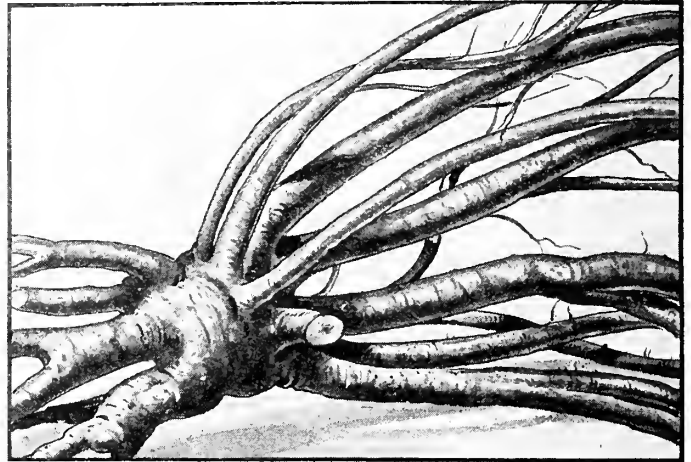

KUDZU ROOTS

For forage and grazing.

To many farmers in the locality of Philadelphia this may appear as a new thing, although it has been used very extensively in the South for hay and grazing. The roots which we furnish are planted as one would Asparagus and Rhubarb, requiring 1600 roots for an acre. All cattle thrive on it and prefer it to almost any other hay; absolutely hardy, one planting will last almost forever, while propagating stock may be taken from it for establishing new fields. It is a legume requiring no fertilizer but rather introducing this into the soil in the form of nitrogen. Also makes a splendid green food for poultry. The dormant roots which can be supplied from about December 1st to May 15th, are set in rows five feet apart, and the same distance in the rows. Price for strong roots, \$1.50 per doz.; per 100, \$8.00. Complete Descriptive Cultural Circular, free upon application.

MILLET

Can be sown as late as July 15th and yield a tremendous crop. Is also desirable for green manuring, when it should be turned under when about 10 inches high. Makes an excellent green food for stock. If used for hay it should be cut just as it matures.

Hungarian. The seed produces hay not so fine in quality as the "Golden," also fully a foot less in height. It can, however, be sown some 2 weeks later. Sow 1 bushel (50 lbs.) per acre.

Japanese Barnyard. This wonderful Millet yields possible more fodder than any other forage plant. Frequently as high as 12 tons of green food has been obtained from an acre. If sown early in May it may be cut twice in one season. Sow 12 lbs. per acre broadcast, any time from May 1st to June 15th.

Tennessee Golden. This requires a longer season to mature than the other sorts; it produces a very fine quality of hay and makes a larger seed head. In good seasons it grows about 4 ft. high. Sow 1 bu. (50 lbs.) broadcast to the acre, from April 10th to July 10th. Price upon application.

2 Bu. Seamless Bags required in shipping all Farm Seeds are chargeable at 40c. each, but are returnable for credit.

ALL PRICES SUBJECT TO MARKET CHANGES

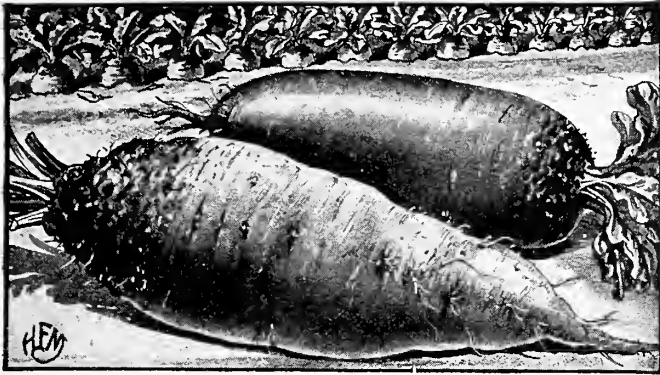

Michell's Mammoth Long Red and Golden Tankard Mangels

MANGEL WURZEL

Sow 5 lbs. per acre in April and May in thoroughly plowed, well-manured soil, in drills about 24 inches apart. Thin out to 12 inches apart in the row, and keep the weeds down by frequent hoeing and cultivating. Low ground is best adapted for Mangel-Wurzels. They provide excellent winter food for cattle, sheep hogs and poultry.

Golden Tankard. The best long yellow mangel in cultivation. Relished by cows, sheep and hogs. Matures earlier than other large sorts. Per oz., 10c.; 25c. per ¼ lb.; lb., 75c.; \$3.25 per 5 lbs.

Lane's Improved White Sugar. This variety attains an enormous size, growing considerably above the ground; one of the best for stock feeding. Per oz., 10c.; 25c. per ¼ lb.; lb., 75c.; \$3.25 per 5 lbs.

Mammoth Long Red. This is an enormously productive variety, yielding from 50 to 75 tons to the acre, a single root often weighing from 20 to 40 pounds. It is the best long red mangel. Per oz., 10c.; 25c. per ¼ lb.; lb., 75c.; \$3.25 per 5 lbs.

Red Globe. An excellent sort; very prolific; good for late planting. Per oz., 10c.; 25c. per ¼ lb.; lb., 75c.; \$3.25 per 5 lbs.

If Mangel Wurzel seed is desired by mail, please add postage, as per parcel post table on page 1.



Seed Oats, Canadian Cluster

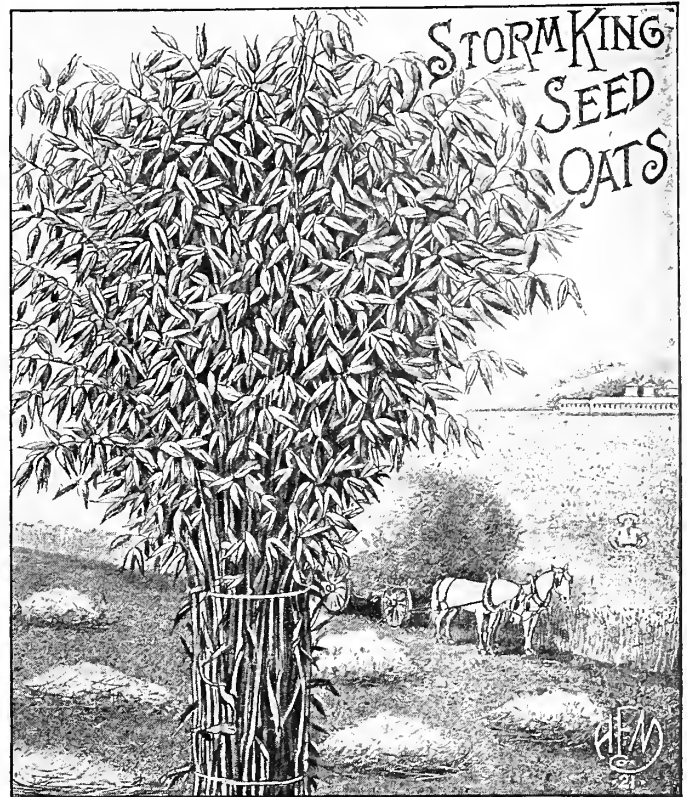

SEED OATS

We make quite a specialty of these, having them grown especially on contract for us; they are large, plump, free from weed seeds or other foreign substance, and of high vitality. Sow them at the rate of 2½ to 3 bushels per acre alone or 1½ bushels with peas, during April, for best results.

Canadian Cluster. An enormous yielder, producing very large heads. Originally brought from the oats belt of Canada, but now thoroughly acclimated in the United States.

Storm King (Pedigree Stock). Our strain of this variety was brought from Russia five years ago, and is, without a doubt, the finest and plumpest oats we have ever seen. The straw is very stiff, often measuring five feet in height. Often yields 85 bushels per acre.

Swedish or Washington. The long, erect straw is noted for its ability to stand up in rough weather; grains are very plump and nearly pure white in color.

Tartar King. This is one of the popular varieties; extensively grown in the locality of Philadelphia; it yields a heavy, stiff straw and is a large producer.

Price of Oats on application.

Nitrogen Gathering Bacteria

On page 42 are listed and described 4 leading brands of Legume Cultures, every one who plants should be acquainted with this modern method of increasing crops and fertilizing the soil. Descriptive circular on request.



FORMALDEHYDE

Improved Treatment for Oats Smut

Use one pint of Formaldehyde in 10 pints of water and with a spray pump direct a spray into each shovelful of grain as it is being shoveled over on a clean floor or canvas. This quantity, 11 pints, will treat 55 bushels at the rate of 1 pint to 5 bushels. Grain may be immediately sacked. Formaldehyde will increase the yield of oats, wheat, barley and rye materially. Per pint bottle, 50c.

COW PEAS

Cow Peas are one of the best, largest yielding and most nutritious of the farm crops; they provide the most inexpensive methods of bringing soil back to a stage of fertility. On ordinary ground they will yield from 10,000 to 20,000 lbs. of green fodder to the acre. They grow in the poorest kind of soil, leaving it very rich in ammonia. In the latitude of Philadelphia sow from May 1st to July 1st, two bushels per acre broadcast, or one bushel per acre in drills. For a large crop sow the seed as late as possible.

Black. One of the popular varieties extensively grown. It is very prolific and matures early. It is of upright growth, consequently preferred for ploughing under or for grazing stock.

Large Black Eye. An exceedingly heavy cropper, but late to mature. In the South the seed of this variety is sold for dried peas for household use; it is claimed they are quite delicious.

Whippoorwill. Medium early; upright growing; a variety more extensively used than any other. The seed is gray speckled, a heavy producer of both pods and fodder. Some claim this variety gathers more nitrogen than others.

Mixed. All varieties for hay or for plowing under.

Prices: These fluctuate constantly; will be quoted on request.



A Field of Cow Peas

CANADIAN FIELD PEAS

These are used for various purposes, among them being an early green food for cattle; sow with oats about April 1st, 1½ bushels of Peas and 1½ bushels of Oats to the acre, either drilled or broadcasted. They are cut just after the peas flower, and fed green. They may be sown successively up to July, if one has the available land. Peas may also be sown alone, at the rate of 3 bushels per acre, and furnish excellent hay. The dried peas are fed to pigeons, while when ground as meal are an excellent addition to the regular food of cows, sheep and horses. Price changes constantly and will be quoted on request.



A Bumper Crop of Spring Rye

RAPE

Dwarf Essex. This can be pastured 8 weeks after sowing; sow in succession, as the stock eat it close to the ground and it will not stand pasturing any great length of time. Sow 6 lbs. per acre broadcast, from April 1st to October 1st. It produces enormous crops, and is ideal green manure. Stock feeding on it, should have ready access to salt. Price on application.



Sorghum Makes Fine Green Food for Dairy Cows

SUGAR CANE or SORGHUM

Early Amber. Either green or in a cured state this makes ideal cattle food; it imparts a desirable flavor to milk. The seed can be threshed out of the stalks and used as poultry feed. It is a tremendous producer, growing often 12 feet high; it stands the hot, dry weather and can be cut several times in one season. Sow 25 lbs. of seed to the acre in drills 3½ feet apart; 1 or 2 bushels broadcast. 50 lbs. per bushel. Price on application.

NITROGEN-GATHERING BACTERIA. This will be found a very valuable preparation in connection with plantings of Cow Peas. See page 42 for full particulars.

RYE (For Seeding)

Spring. An excellent early green food, or for pasture; the grain is used for feeding and other purposes, while the straw is a very fine quality, making a larger yield than the winter rye from which it is quite distinct, the seed being smaller. Sow from May 1st to June 1st. 56 lbs. per bu. Don't sow Winter Rye in Spring as it will not grow at that season.

Pennsylvania White Winter. This may be sown in the autumn as late as November, making a very fine yield of long, stiff straw, or may be used as a cover crop. Winter rye will not mature if sown in spring.

Rosen Winter Rye. An improvement on the Pennsylvania White Winter Rye, from a standpoint of yield, as to grain and straw. Weight of rye is 56 lbs. per bushel, sow 1½ bushels per acre. Prices upon application.

Two bushel seamless sacks, used in shipping farm seeds, are charged for at 40c. each; returnable at price charged.

SPELTZ, or EMMER

This seed resembles barley, but is a much larger yielder, producing frequently as high as 80 bushels of grain per acre, and that on the poorest land. The hay if cut green is desirable for horse or cattle feed, while the straw after threshing is equal to wheat straw. The grain is desirable for feeding to hogs or poultry. Sow as you would wheat, 2 bushels to the acre any time after April 1st; the earlier the better. 40 lbs. per bushel. Price on application.

SUDAN GRASS

An annual, and must be sown each year. Resembles millet somewhat; stock seems to relish it; will yield from 2 to 4 tons per acre. Sow in drills or broadcast 16 to 24 lbs. per acre; several cuttings can be made from a sowing in one season. Thrives excellently in a season of drought. On account of the uncertainty of the crop, price will be quoted on application.

SUNFLOWER

Mammoth Russian. This makes a splendid poultry food, especially for winter use, on account of its heating and fattening qualities. Will yield sometimes as high as sixty bushels per acre. Harvest after first few frosts, cutting the seed head from the plant, piling them loosely on the grain floor or hanging them in bunches on the rafters of the barn until thoroughly dry. Sow 10 qts. per acre in drills 3 feet apart, dropping the seed about every 4 inches. Prices (subject to change). 15c. per lb.; 5 lbs., 70c.; \$1.35 per 10 lbs.; bushel (25 lbs.), \$3.25.

TIMOTHY SEED

Our stocks of this important hay producing seed are especially fine; thoroughly re-cleaned, being free from weeds. If sown alone it requires 1/2 bushel to seed an acre; if sown with wheat 8 to 10 quarts are the usual quantities. 45 lbs. per bushel. Samples and quotations on request.

VETCHES, or TARES

This has been used in Europe for many years as a stock food and green manuring or cover crop. It does best if sown with rye; the latter gives it support and thus ensures enormous crops. It makes an ideal hay and it is a pity that every American farmer does not use it. It fertilizes the ground without further trouble or cost, on account of the free nitrogen it gathers from the air. It produces a peculiar vine plant with very narrow foliage and elongated flowers of pinkish lavender, in clusters. The height when supported is frequently 4 feet.

Winter Vetch (*Vicia Villosa*). Sometimes called Sand or Hairy Vetch. Our stock of this is the true type, being imported by us direct from Russia, which will absolutely live throughout the winter.

There is also an English strain on the market which is not hardy in the northern sections of the United States, and buyers should beware when buying that they procure the right article, which is a small round black seed; this is far superior to Crimson Clover, as it never winter-kills. Sow from August 1st to October 1st, but the earlier the better, broadcast, 1 bushel per acre, to which we suggest adding a bushel of winter rye or wheat. In the spring it can be plowed under as green manure, or when in flower cut for hay. All stock relish it keenly. Price on application.

Spring Vetch (*Vicia Sativa*). The seed of this is larger than the "Winter" and of a brownish gray color. It is not hardy and must, therefore, be sown in the spring during May or June, 1 to 2 bushels per acre if broadcast, and 1 bushel if in drills, with either spring wheat, spring rye or oats, for support. Has the same desirable features as the winter vetch. Price on application.

SPRING WHEAT

A desirable crop to sow where fall sown wheat has been killed by severe winter; the grain is very hard, of excellent milling quality. Macaroni is made from this variety. Our stock is grown in the extreme Northwest and is very fine.

Saskatchewan Fife. This is the favorite sort in this locality and is used on account of its prolific, vigorous growth and early qualities. It often produces 50 bushels per acre. Sow in April or May, 1 1/2 to 2 bushels per acre, broadcast or in drills. Price on application.



Spring Wheat



Winter Vetch

Special Notice. On page 42 are offered two reliable brands of inoculating bacteria for such crops as clover, alfalfa, cow-peas, soja beans, vetch, etc. An assurance of a large crop will warrant their use.

In ordering Farm Seeds allow 40c. for each Two-Bushel Bag. These are returnable at the price charged. (oh)

Abutilon—*Flowering Maple*.
 Abyssinian Banana—*Musa Ensete*.
 Achillea—*Milfoil, Sneezewort*.
 Aconitum—*Helmet Flower, Monk's Hood, Wolf's Bane*.
 Acroclinium—*Everlastings*.
 Adam's Needle—*Yucca*.
 Adiantum—*Maiden Hair Fern*.
 Adlumia—*Allegheny Vine, Mountain Fringe*.
 Adonis aestivalis—*Pheasant's Eye*.
 African Daisy—*Arcletis*.
 African Lily—*Agapanthus*.
 Agapanthus—*African Lily*.
 Ageratum—*Floss Flower*.
 Agrostemma—*Rose Campion*.
 Allegheny Vine—*Adlumia*.
 Aloysia citriodora—*Lemon Verbena*.
 Althaea rosea—*Hollyhock*.
 Althaea—*Rose of Sharon*.
 Alum Root—*Heuchera*.
 Alyssum saxatile—*Basket of Gold*.
 Amaranthus caudatus—*Love Lies Bleeding*.
 Amaranthus tricolor—*Joseph's Coat*.
 Amaryllisformosissima—*Jacobean Lily*.
 Amethyst—*Browallia*.
 Ampelopsis—*Virginia Creeper*.
 Ampelopsis Veitchii—*Boston Ivy*.
 Anchusa—*Sea Bugloss*.
 Anemone—*Windflower*.
 Anthericum—*St. Bruno's Lily*.
 Antirrhinum—*Snapsdragon*.
 Aquilegia—*Columbine*.
 Arabis—*Rock Cress*.
 Arctotis—*African Daisy*.
 Aristolochia—*Dutchman's Pipe*.
 Armeria—*Sea Pink, Thrift*.
 Artemisia absinthium—*Wormwood*.
 Asclepias—*Butterfly Weed*.
 Asparagus Fern—*Asparagus plumosus*.
 Asperula—*Waldmeister, Woodruff*.
 Baby's Breath—*Gypsophila*.
 Baby Primrose—*Primula Forbesi*.
 Bachelor's Button—*Centaurea, Gomphrena, Bellis*.
 Balloon Vine—*Cardiospermum*.
 Balsam—*Lady Slipper*.
 Balsam Apple—*Monardica*.
 Baptisia—*False Indigo*.
 Barberry—*Berberis*.
 Basket of Gold—*Alyssum saxatile*.
 Beard Tongue—*Pentstemon*.
 Bee Balm—*Monarda*.
 Bell Flower—*Campanula*.
 Bellflower Lily—*Lilium canadense*.
 Bellis—*Bachelor's Button, English Daisy*.
 Berberis—*Barberry*.
 Bergamot—*Monarda*.
 Bignonia—*Trumpet Vine*.
 Black Eyed Susan—*Thunbergia*.
 Blanket Flower—*Gaillardia*.
 Blazing Star—*Liatris*.
 Bleeding Heart—*Dielytra*.
 Blue Bottle—*Centaurea cyanus*.
 Bluets—*Centaurea cyanus*.
 Boconia—*Plume poppy*.
 Boltonia—*False Chamomile*.
 Boston Ivy—*Ampelopsis Veitchii*.
 Boxwood—*Buxus*.
 Brachycome—*Swan River Daisy*.
 Bridal Wreath—*Spiraea prunifolia*.
 Briza—*Quaking Grass*.
 Browallia—*Amethyst*.
 Buddleia—*Butterfly Bush*.
 Bush Eschscholtzia—*Hunnemannia*.
 Buttercup—*Trollius*.
 Butterfly Bush—*Buddleia*.
 Butterfly Flower—*Schizanthus*.
 Butterfly Pea—*Centrosema*.
 Butterfly Weed—*Asclepias*.
 Buttonwood—*Platanus orientalis*.
 Buxus—*Borwood*.
 Cactalia—*Tassel Flower*.
 Caladium—*Elephant's Ear*.
 Calendula—*Pot Marigold*.
 California Poppy—*Eschscholtzia*.
 Callirhoe—*Poppy Mallow*.
 Calycanthus—*Sweet Shrub*.
 Campanula calyc. — *Cup and Saucer*.
 Campanula carpatica—*Hare Bell*.
 Campion—*Lychnis*.
 Canarybird Flower—*Tropaeolum Canariense*.
 Candytuft—*Iberis*.
 Canna—*Indian Shot*.
 Canterbury Bells—*Campanula*.
 Cape Jessamine—*Gardenia florida*.
 Cardinal Flower—*Lobelia cardinalis*.
 Castor Oil Beans—*Ricinus*.
 Catchfly—*Silene*.
 Catalpa—*Umbrella Tree*.
 Centaurea cyanus—*Bachelor's Button, Cornflower, Blue Bottle, Bluets, Ragged Sailor*.
 Centaurea moschata—*Sweet Sultan*.
 Celosia cristata—*Cockscomb*.
 Cerastium—*Snow in the Summer*.
 Cercis—*Judas Tree*.
 Chinese Bell Flower—*Platycodon*.
 Chinese Lantern Plant—*Physalis*.

Christmas Rose—*Helleborus Niger*.
 Chrysanthemum frutescens—*Marguerite, Paris Daisy*.
 Cigar Plant—*Cuphea platycentra*.
 Clove Pinks—*Dianthus plumarius*.
 Cockscomb—*Celosia cristata*.
 Coix—*Job's Tears*.
 Columbine—*Aquilegia*.
 Cone Flower—*Rudbeckia*.
 Convolvulus—*Morning Glory*.
 Coral Lily—*Lilium tenuifolium*.
 Cornflower—*Aster Stokesia*.
 Cornflower—*Centaurea cyanus*.
 Cornus florida—*Dogwood*.
 Cowslip—*Primula veris*.
 Crane's Bill—*Geranium*.
 Crataegus—*Hawthorn*.
 Cup and Saucer—*Campanula calyc.*
 Cuphea platycentra—*Cigar Plant*.
 Cycas—*Sago Palm*.
 Cyperus—*Umbrella Plant*.
 Cypress Vine—*Ipomea Quamoclit*.
 Cytisus—*Golden Chain*.
 Daisy—*Bellis perennis*.
 Datura cornucopia—*Horn of Plenty*.
 Datura—*Trumpet Flower*.
 Day Lily—*Funkia, Hemerocallis*.
 Delphinium—*Larkspur*.
 Dianthus barbatus—*Sweet William*.
 Dianthus—*Pinks*.
 Dielytra—*Bleeding Heart*.
 Dictamnus—*Gas Plant*.
 Digitalis—*Foxglove*.
 Dimorphotheca—*Orange Daisy*.
 Dogwood—*Cornus florida*.
 Dolichos—*Hyacinth Bean*.
 Doronicum—*Leopard's Bane*.
 Dusty Miller—*Centaurea gymnocarpa*.
 Dusty Miller—*Cineraria Maritima*.
 Dutchman's Pipe—*Aristolochia*.
 Echinops—*Globe Thistle*.
 Echinocystis—*Wild Cucumber*.
 Edelweiss—*Leontopodium*.
 Egyptian Lotus—*Nelumbium*.
 Elephant Ears—*Caladium*.
 English Daisy—*Bellis*.
 English Primrose—*Primula vulgaris*.
 Erianthus—*Plume Grass*.
 Eryngium—*Sea Holly*.
 Eulalia—*Zebra Grass*.
 Euphorbia—*Mexican Fire Plant*.
 Evening Primrose—*Oenothera*.
 Everlastings—*Acroclitum, Gomphrena, Helichrysum, Rhodanthe, Xeranthemum*.
 Everlasting Pea—*Lathyrus latifolius*.
 Exochorda grandiflora—*Pearl Bush*.
 Fairy Lily—*Zephyranthes*.
 False Chamomile—*Boltonia*.
 False Indigo—*Baptisia*.
 Feather Grass—*Stipa*.
 Feverfew—*Matricaria*.
 Flax—*Linum*.
 Fleur de lis—*Iris germanica*.
 Floss Flower—*Ageratum*.
 Flowering Maple—*Abutilon*.
 Flowering Tobacco—*Nicotiana*.
 Forget-me-not—*Myosotis*.
 Forsythia—*Golden Bell*.
 Fountain Grass—*Pennisetum*.
 Four o'Clocks—*Mirabilis*.
 Foxglove—*Digitalis*.
 Fuchsia—*Lady's Ear Drop*.
 Funkia—*Day Lily*.
 Gaillardia—*Blanket Flower*.
 Gardener's Garters—*Phalaris*.
 Garden Heliotrope—*Valeriana*.
 Gardenia florida—*Cape Jessamine*.
 Gay Feather—*Liatris*.
 Gas Plant—*Dictamnus*.
 Gentian—*Gentiana*.
 Geranium—*Crane's Bill*.
 Gilliflower—*Stocks*.
 Globe Amaranth—*Gomphrena*.
 Globe Flower—*Trollius*.
 Globe Thistle—*Echinops*.
 Gold Dust—*Alyssum saxatile*.
 Golden Bell—*Forsythia*.
 Golden Chain—*Cytisus*.
 Golden Feather—*Pyrethrum aureum*.
 Golden Rod—*Solidago*.
 Gomphrena—*Everlastings, Globe Amaranth, Bachelor's Button*.
 Grass Pinks—*Dianthus plumarius*.
 Gynarium—*Pampas Grass*.
 Gypsophila—*Baby's Breath*.
 Hare Bell—*Campanula carpatica*.
 Hawthorn—*Crataegus*.
 Heart's Ease—*Pansy*.
 Helenium—*Sneezewort*.
 Helianthemum—*Rock Rose*.
 Helianthus—*Sunflower*.
 Helichrysum—*Strawflower*.
 Helleborus niger—*Christmas Rose*.
 Helmet Flower—*Acoytum*.
 Hemerocallis—*Day Lily*.
 Hesperis—*Sweet Rocket, Rocket*.
 Heuchera—*Alum Root*.
 Hollyhocks—*Althaea rosea*.

Honesty—*Lunaria*.
 Hops—*Humulus*.
 Hordeum—*Squirrel Tail Grass*.
 Horn of Plenty—*Datura cornucopia*.
 Hunnemannia—*Bush Eschscholtzia*.
 Hyacinth Bean—*Dolichos*.
 Ice Plant—*Mesembryanthemum*.
 Indian Shot—*Canna*.
 Ipomea noctiflora—*Moonflower*.
 Ipomea Quamoclit—*Cypress Vine*.
 Jacobean Lily—*Anaryllis formos.*
 Jacobaea—*Senecio*.
 Japan Pinks—*Dianthus Heddewigii*.
 Jerusalem Cherry—*Solanum capsicastrum*.
 Job's Tears—*Coix*.
 Judas Tree—*Cercis*.
 Joseph's Coat—*Amaranthus tricolor*.
 Kalmia latifolia—*Mountain Laurel*.
 Kenilworth Ivy—*Linaria cymbalaria*.
 Kochia—*Mexican Fire Bush, Summer Cypress*.
 Kudzu Vine—*Pueraria*.
 Lady's Ear Drop—*Fuchsia*.
 Lady's Slipper—*Balsam*.
 Larkspur—*Delphinium*.
 Lathyrus latifolius—*Everlasting Pea*.
 Leadwort—*Plumbago*.
 Lemon Verbena—*Aloysia citriodora*.
 Leontopodium—*Edelweiss*.
 Leopard's Bane—*Doronicum*.
 Liatris—*Gay Feather*.
 Lilac—*Syringa*.
 Lily of the Valley—*Convallaria*.
 Lobelia cardinalis—*Cardinal Flower*.
 Loose Strife—*Lythrum*.
 Love Grove—*Nemophila*.
 Love in a Mist—*Nigella*.
 Love Lies Bleeding—*Amaranthus caudatus*.
 Lunaria cymbalaria—*Kenilworth Ivy*.
 Luffa—*Cucumis acutangulus*.
 Lunaria—*Honesty, Moonwort*.
 Lychnis—*Ragged Robin, Rose Campion*.
 Lythrum—*Loose Strife*.
 Maiden Hair Fern—*Adiantum*.
 Mallow—*Hibiscus*.
 Marguerite—*Chrysanthemum frutescens*.
 Marigold—*Tagetes*.
 Marshmallow—*Hibiscus*.
 Marvel of Peru—*Mirabilis*.
 Mathiola—*Night Scented Stock*.
 Matricaria—*Feverfew*.
 Meadow Rue—*Thalictrum*.
 Mesembryanthemum—*Ice Plant*.
 Mexican Fire Bush—*Kochia*.
 Mexican Fire Plant—*Euphorbia*.
 Michaelmas Daisy—*Aster perennis*.
 Mignonette—*Reseda*.
 Mimosa—*Sensitive Plant*.
 Mimulus moschatus—*Musk Plant*.
 Mirabilis—*Four o'Clocks, Marvel of Peru*.
 Mock Orange—*Philadelphus*.
 Momordica Balsamina—*Balsam Apple*.
 Monarda—*Bee Balm, Bergamot*.
 Monk's Hood—*Aconitum*.
 Moonflower—*Ipomea noctiflora*.
 Moonwort—*Lunaria*.
 Morning Glory—*Convolvulus*.
 Moss Pink—*Phlox subulata*.
 Mountain Fringe—*Adlumia*.
 Mountain Laurel—*Kalmia latifolia*.
 Mourning Bride—*Scabiosa*.
 Musa ensete—*Abyssinian Banana*.
 Musk Plant—*Mimulus moschatus*.
 Myosotis—*Forget-me-not*.
 Myrtle—*Vinca minor*.
 Nelumbium—*Egyptian Lotus*.
 Nemophila—*Love Grove*.
 Nicotiana—*Flowering Tobacco*.
 Nigella—*Love in a Mist*.
 Night Scented Stock—*Mathiola*.
 Oenothera—*Evening Primrose*.
 Orange Daisy—*Dimorphotheca*.
 Ox-Eye—*Adonis vernalis*.
 Painted Tongue—*Salpiglossis*.
 Pampas Grass—*Gynarium*.
 Pancratium Lily—*Ismene calathina*.
 Paris Daisy—*Chrysanthemum frutescens*.
 Passiflora—*Passion Flower*.
 Peach Bells—*Campanula persicifolia*.
 Pearl Bush—*Exochorda grandiflora*.
 Periwinkle—*Vinca*.
 Phalaris—*Gardener's Garters*.
 Phalaris—*Ribbon Grass*.
 Pheasant's Eye—*Adonis aestivalis*.
 Philadelphus—*Mock Orange*.
 Phlox drummondii—*Flame Flower*.
 Phlox subulata—*Moss Pink*.
 Pincushion Flower—*Scabiosa*.
 Pinks—*Dianthus*.
 Platanus orientalis—*Buttonwood*.
 Platycodon—*Chinese Bell Flower*.
 Plumbago—*Leadwort*.
 Plume Grass—*Erianthus*.
 Plume Poppy—*Boconia*.
 Polyanthus—*Primula elatior*.
 Poppy Mallow—*Callirhoe*.

Poppy—*Papaver*.
 Pot Marigold—*Calendula*.
 Pueraria—*Kudzu Vine*.
 Pyrethrum aureum—*Golden Feather*.
 Quaking Grass—*Briza*.
 Rag Gourd—*Cucumis acutangulus*.
 Ragged Robin—*Lychnis*.
 Ragged Sailor—*Centaurea cyanus*.
 Red Bud—*Cercis canadensis*.
 Red Hot Poker Plant—*Tritoma*.
 Reed—*Arundo donax*.
 Reseda—*Mignonette*.
 Rhodanthe—*Everlastings*.
 Ribbon Grass—*Phalaris*.
 Rock Cress—*Arabis*.
 Rocket—*Hesperis*.
 Rock Rose—*Helianthemum*.
 Rose Campion—*Agrostemma*.
 Rose Camion—*Lychnis*.
 Rose of Sharon—*Althaea*.
 Rudbeckia—*Cone Flower*.
 Sago Palm—*Cycas*.
 Salpiglossis—*Painted Tongue*.
 Saponaria—*Soapwort*.
 Satin Flower—*Godetia*.
 Scabiosa—*Mourning Bride*.
 Scabiosa—*Pincushion Flower*.
 Scarlet Sage—*Salvia splendens*.
 Schizanthus—*Butterfly Flower*.
 Sea Bugloss—*Anchusa*.
 Sea Lavender—*Statice*.
 Sea Holly—*Eryngium*.
 Sea Pink—*Armeria*.
 Sedum—*Stoncrop*.
 Senecio—*Jacobaea*.
 Sensitive Plant—*Mimosa*.
 Silene—*Catchfly*.
 Silk Oak—*Grevillea*.
 Snapsdragon—*Antirrhinum*.
 Sneezewort—*Helentium*.
 " — *Achillea*.
 Snowball—*Viburnum*.
 Snowberry—*Symphoricarpos*.
 Snow in the Summer—*Cerastium*.
 Snow on the Mountain—*Euphorbia*.
 Soapwort—*Saponaria*.
 Solanum capsicastrum — *Jerusalem Cherry*.
 Solidago—*Golden Rod*.
 Speedwell—*Veronica*.
 Spider Plant—*Cleome*.
 Squirrel Tail Grass—*Hordeum*.
 Star of Bethlehem—*Ornithogalum*.
 Statice—*Sea Lavender*.
 St. Bruno's Lily—*Anthericum*.
 St. John's Wort—*Hypericum*.
 Stoncrop—*Sedum*.
 Stipa—*Feather Grass*.
 Stocks—*Gilliflower*.
 Stokesia—*Cornflower Aster*.
 Strawflower—*Helichrysum*.
 Summer Cypress—*Kochia*.
 Sunflower—*Helianthus*.
 Swan River Daisy—*Brachycome*.
 Sweet Pepper Bush—*Cheltra*.
 Sweet Rocket—*Hesperis*.
 Sweet Shrub—*Calycanthus*.
 Sweet Sultan—*Centaurea moschata*.
 Sweet William—*Dianthus barbatus*.
 Symphoricarpos—*Snowberry*.
 Syringa—*Lilac*.
 Tagetes—*Marigold*.
 Tassel Flower—*Cactalia*.
 Thrift—*Armeria*.
 Thunbergia—*Black Eyed Susan*.
 Tobacco—*Nicotiana*.
 Trillium—*Wake Robin, Wood Lily*.
 Tritoma—*Red Hot Poker*.
 Trollius—*Buttercup*.
 Trumpet Flower—*Datura*.
 Trumpet Vine—*Bignonia*.
 Tufted Pansies—*Viola cornuta*.
 Turk's Cap Lily—*Lilium superbum*.
 Umbrella Plant—*Cyperus*.
 Umbrella Tree—*Catalpa*.
 Valeriana—*Garden Heliotrope*.
 Viburnum—*Snowball*.
 Vinca minor—*Myrtle*.
 Vinca—*Periwinkle*.
 Viola cornuta—*Tufted Pansies*.
 Virgin's Bower—*Clematis*.
 Virginia Creeper — *Ampelopsis quinquefolia*.
 Waldmeister—*Asperula*.
 Wallflower—*Cheiranthus*.
 Wild Cucumber—*Echinocystis*.
 Windflower—*Anemone*.
 Wolf's Bane—*Aconitum*.
 Wood Lily—*Trillium*.
 Wood Fern—*Aspidium*.
 Woodruff—*Asperula*.
 Wormwood—*Artemisia absinthium*.
 Xeranthemum—*Everlastings*.
 Yarrow—*Achillea*.
 Youth and Old Age—*Zinnia*.
 Yucca—*Adam's Needle*.
 Zebra Grass—*Eulalia*.
 Zephyranthes—*Fairy Lily*.

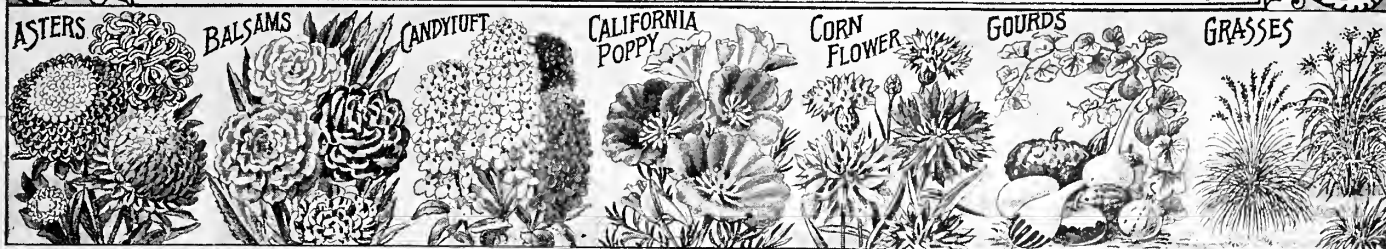

Michell's Collections of Popular Old-Fashioned Flowers

On this page the lover of Old-Fashioned Flowers will find a selection of all the better varieties grouped under their respective names. They are also listed through the Flower Seed pages, where they are described more fully.

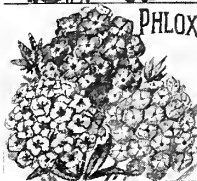

- ASTERS**—Michell's Improved Simple's Branching, in 6 charming and distinct colors; late bloomers. \$0.50
- Michell's Invincible. Profuse flowering; massive paeony formed flowers; 5 colors40
- New Crego. Twisted and curled petals like a huge chrysanthemum; splendid varieties, in 6 colors.50
- Early Royal Branching. Bloom in July and August; 5 colors.40
- Queen of the Market. In 6 grand colors; very fine.50
- Giant Comet. Flowers of exquisite form; 5 colors.40
- BALSAMS**—Double Camellia Flowered. A greatly improved strain of these old favorites in 6 colors; very double.50
- CALIFORNIA POPPIES** (*Eschscholtzia*). Their brilliant colors make the garden gay; very useful for cutting; 8 varieties.60
- CANDYTUFT**. Flowers within six weeks after sowing, and will give a mass of attractive blooms; 6 colors.50
- CORN FLOWER, GIANT** (*Centaurea or Sweet Sultan*). An old favorite garden annual; 6 colors.50
- GRASSES** (Ornamental). In 11 grand varieties.75
- HOLLYHOCKS**. No garden should be without these very showy plants; 6 grand and distinct colors.50
- LARKSPUR**. Excellent annuals for cutting; 6 colors.50
- MARGOLDS**. Double French. Profuse bloomers and always showy; 6 imported varieties.40
- Double African; 6 distinct sorts.40
- MIGNONETTE**. Ever a favorite in the garden, and will bloom until frost; 6 varieties.40
- NASTURTIUMS**. Invaluable as showy garden plants.
 - Dwarf. 12 distinct sorts; one pkt. each.50
 - Tall. 12 distinct sorts; one pkt. each.50
- PANSY**. No garden is a garden without Pansies. Ours are admitted to be the finest in existence.
 - Giant Prize. 6 grand colors; fine.75
 - Giant Prize. 12 grand colors; exquisite. 1.40
 - Regular Sorts. 6 fine colors.50
 - Regular Sorts. 12 fine colors.90
- PETUNIAS**. A greatly improved strain in colors and size; immense frilled flowers; single; 6 colors.75

- PHLOX DRUMMONDII**. Grandiflora. 12 very beautiful and gaudy imported sorts. . . . \$0.75
- PINKS** (*Dianthus*). Their delicious odor makes them ever attractive. Odd forms in 6 varieties.40
- POPPIES**. Single Annual. Rich in colors. The most showy flowers in the garden and great favorites; 7 single sorts.50
- Double Annual. 6 colors.50
- PORTULACA**. Single. 8 varieties.30
- Double. The finest imported that can be had; 6 gorgeous colors; grand.50
- PRIMROSE** (*Primula Chinensis*). Every one loves them; these 8 imported sorts are grand.75
- SALPICLOSSIS**. Very curious and interesting forms; many are quite new; 6 colors.50
- SNAPDRAGONS** (*Antirrhinum*). Old standbys for showy groups.
 - Michell's Giant Tall. 6 colors.50
 - Michell's Semi-Dwarf. 6 colors.50
- MOURNING BRIDE** (*Scabiosa*). Excellent hardy annuals; fine for cutting; 6 colors.50
- STOCKS**. Flower Market. Plants branch freely and produce from 10 to 15 spikes of flowers; 6 colors.75
- Dwarf Ten-Week. 6 colors.50
- STRAW FLOWER** (*Helichrysum*). Beautiful everlasting flowers, remaining perfect for months; 6 colors.50
- SWEET PEAS**. Spencer or Orchid-Flowering. A grand selection of 12 varieties, all beautiful and distinct. 1.00
- VERBENAS**. Mammoth Fancy. The kinds that bear the largest flowers; 6 colors.50
- WALL FLOWER**. Single. Well-known favorites of distinct colors; 6 imported varieties. . . .40
- Double. Very fine, compact trusses; 6 varieties.50
- ZINNIA**. Dwarf Double. Indispensable in every garden; masses of flowers in all shades; 6 grand colors.40
- Giant Dahlia Flowered. Immense flowers, resembling Dahlias; 8 separate varieties. . . . 1.50
- Giant Double. Finest of all; every shade of color found in Zinnias; 8 colors. 1.00

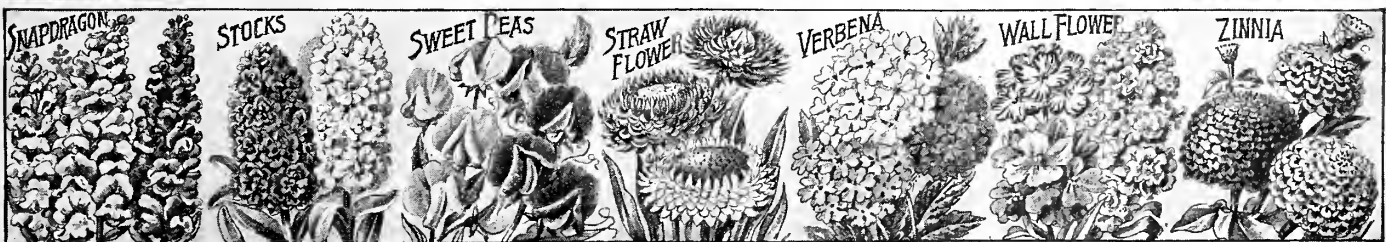

MICHELL'S NOVELTIES AND SPECIALTIES IN FLOWER SEEDS FOR 1923

FOR GENERAL LIST OF FLOWER SEEDS SEE PAGES 57 TO 93

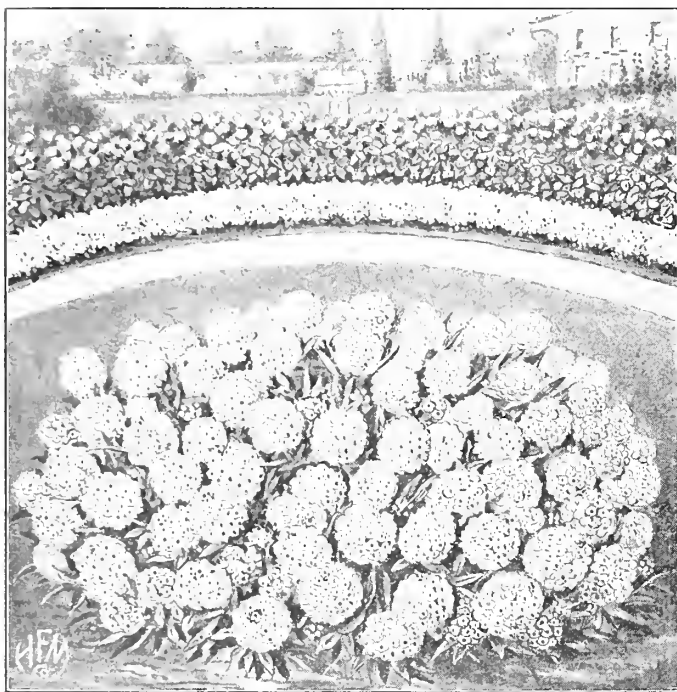

Alyssum, Michell's Bouquet



Aster, Pacific Beauty

ALYSSUM.

MICHELL'S BOUQUET

This new variety is of exceedingly dwarf and compact growth, very free flowering, plants forming a perfect bouquet of miniature white flowers. A perfect gem for edging. Commences to bloom when plants are very small and continues until frost. We have an extra fine strain of this variety. Per pkt., 15c.; 60c. per large pkt.

NEW GIANT SNAPDRAGONS

(*Antirrhinum Maximum*)

An entirely new race of this popular flower, the result of years of careful selection and culture; the flowers are of extraordinary size. The plants are robust and produce the flowers on extra long spikes.

Cattleya. A new giant variety; flowers silver rosy lilac, with golden yellow lip. Per pkt., 25c.; 60c. per large pkt.

Canary Bird. A pure and delicate canary yellow. Per pkt., 25c.; 60c. per large pkt.

Philadelphia Pink. Considered to be the finest pure pink; long, stout stems. Per pkt., 25c.; \$1.25 per large pkt.

Snowflake. Lovely white with fine yellow throat. Per pkt., 25c.; 60c. per large pkt.

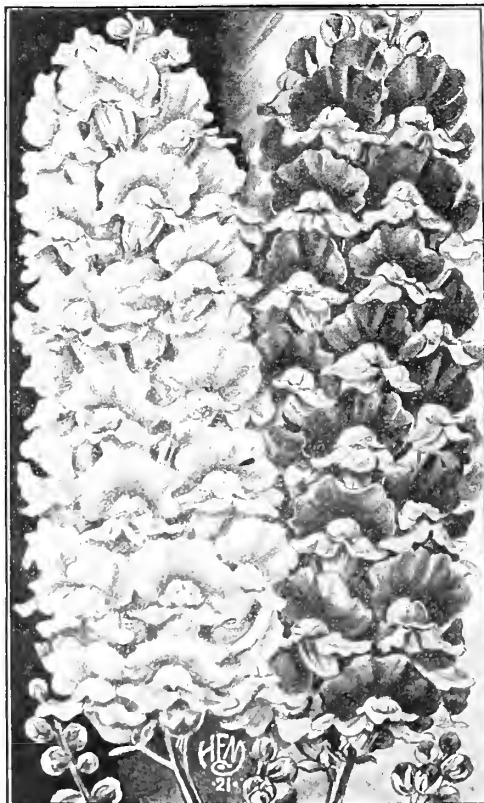

Antirrhinum (Snapdragon) Maximum

ASTER, PACIFIC BEAUTY

A new variety of the Giant Comet type; the petals are wide and long and so gracefully curled as to give it an unusually attractive appearance. The plants are of vigorous growth, bearing a profusion of immense flowers, often measuring five to six inches in diameter. Color, a beautiful shade of rich lavender. Blooms from mid-season to late. Per pkt., 25c.; 75c. per large pkt.

ASTER, PEERLESS YELLOW

Plants are of branching habit and very vigorous; the flowers are large, full ball-shaped, with centers deeply covered with curled and twisted florets. Color, a delicate hue of pure sulphur yellow. Per pkt., 25c.; 75c. per large pkt.

GIANT SNAPDRAGON (*Antirrhinum*)

MICHELL'S SALMON PINK

An excellent strain of this popular florists flower; the plants grow to a height of 2 to 3 feet and produce extra long spikes of large flowers; color, delicate salmon pink. Per pkt., 15c.; 60c. per large pkt.

Special Offer.—One pkt. each of the **Novelties and Specialties** on this page for \$1.60.



Aster, California Giant

**NEW ASTER
CALIFORNIA GIANT**

A new variety of the Crego type, with the robust habit of growth and long stems of the Beauty type. Flowers larger than Crego and stand up well after being cut; their immense size and beauty with their long, sturdy stems make them very attractive.

	Large pkt.	Pkt.		Large pkt.	Pkt.
Dark Purple	\$.075	\$.025	Light Blue	\$.075	\$.025
Deep Rose	.75	.25	Peach Blossom	.75	.25
Collection. One packet each of above 4 colors, 90c.					

**BLUE LACE FLOWER
(Didiscus Coeruleus)**

An easily grown annual which is becoming very popular; the plant grows about 18 inches high and produces attractive, umbel-shaped flowers of lace-like appearance; the color is a delicate azure blue; blooms from July until frost; excellent for cutting. It is also desirable as a pot plant for winter blooming in greenhouse or conservatory. Per pkt., 25c.; 60c. per large pkt.

**THE CARDINAL CLIMBER
(Ipomoea Quamoclit Hybrida)**

A distinct and valuable novelty and one of the most beautiful climbers. A strong and very rapid grower and free bloomer; the vines branch freely, covering a large space very quickly and growing to a height of 20 to 30 feet. Leaves are dark green, fern-like and deeply lacinated; bears a great profusion of fiery, cardinal red flowers, which are about 1½ inches in diameter. It delights in a warm, sunny situation and good soil. In order to have good germination of the seed a small notch should be filed or cut in each seed. Per pkt., 15c.; 75c. per large pkt.

**CELOSIA PLUMOSA
PRIDE OF CASTLE GOULD**

This variety excels all other varieties of this class; plants grow compact and pyramidal, about 2 to 3 feet high, producing immense flower heads, that closely resemble ostrich plumes. Colors are blood red, carmine, yellow, orange, golden, orange scarlet, etc., in mixture. Per pkt., 15c.; 75c. per large pkt.



Aster, Heart of France

ASTER, HEART OF FRANCE

A new variety, description of which we quote from the introducers: "The best pure red Aster ever introduced. Heart of France opens red as the ruby, deepens with age and retains its remarkable beauty to the very end. The petals appear strikingly changeable, showing a glow and sheen quite unique. The flowers are large and full with no trace of a hollow center; the plants are of branching type and very robust; stems long and strong. Per pkt., 25c.; 60c. per large pkt.

Special Offer.—One packet each of the *Novelties* and *Specialties* on this page, for \$1.60.



Blue Lace Flower

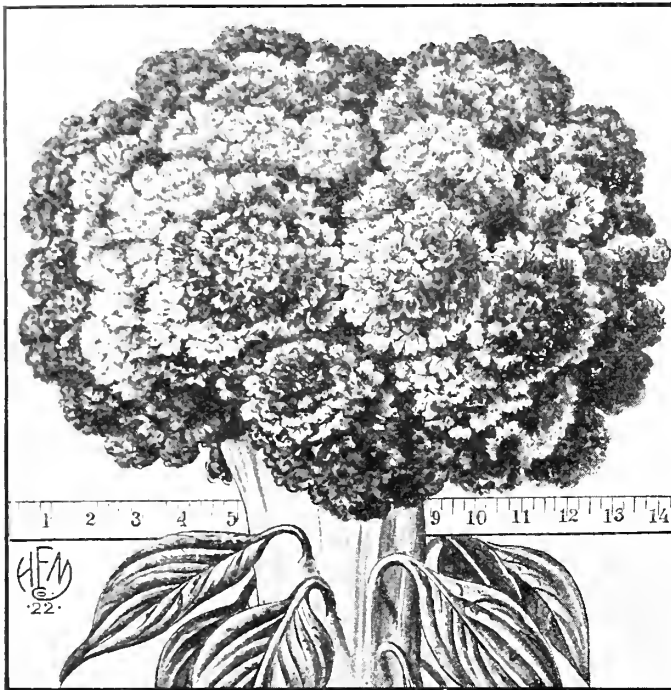

Celosia, Chrysantheflora

CELOSIA, CHRYSANTHEFLORA

This is a cross between *Celosia Cristata* and the *Plumosa* variety, *Pride of Castle Gould*. Plants are half dwarf with immense round heads of flowers in a great variety of colors, including salmon, pink and bronze; blooms from middle of July to Nov. 1st. When cut and hung up-side-down in a dark, cool place they will dry and retain their beauty and color indefinitely. Those who have seen this variety dried commend it highly for bouquets, baskets, etc. Stems 24 to 60 inches long. Per pkt., 40c.; \$1.25 per large pkt.



Cosmos Extra Early Double

**CHRYSANTHEMUM
NEW EARLY FLOWERING
Double and Semi-Double**

A new class of perennial Chrysanthemums which has attracted extraordinary attention on account of their wonderfully showy effect; can also be treated as an annual. Sown in the greenhouse or in the frames in February and transplanted in May, it commences to bloom the early part of July and continues to be in full flower until frost. The flowers come in a variety of colors and include exquisite shades of old rose, coppery red, dark brown, brown with gold edge, etc. The plants grow about one foot high and quite bushy. Excellent for cutting. Per pkt., 35c.; 85c. per large pkt.



**CHINESE WOOLFLOWER, PINK
(*Celosia Childs*)**

An attractive and popular annual. Plants grow about 2½ feet high, and branch freely, each shoot bearing beautiful, ball-shaped pink flowers resembling silky wool. It flowers profusely during summer and fall until frost destroys them. Per pkt., 25c.; 75c. per large pkt.

CHINESE WOOLFLOWER, SCARLET

Large ball-shaped scarlet flowers. Per pkt., 15c.; 60c. per large pkt.

**DOUBLE COSMOS
EXTRA EARLY FLOWERING**

The double flowering strains of *Cosmos* which have been introduced within the last few years are becoming very popular. This new early flowering strain will commence blooming in July and will continue until frost. The flowers are full, round and double and very attractive.

	Large pkt.	Pkt.
Crimson.....	\$0.85	\$0.25
Pink.....	.85	.25
White.....	.85	.25
Mixed Colors.....	.75	.25
Collection. One packet each of above 3 colors,	65c.	

LINARIA MACEDONICA SPECIOSA "Nymph"

A strikingly handsome, hardy perennial Toadflax, a native from the Orient, blooming freely the first year when sown early. The robust and vigorous plants grow 2½ to 3 feet in height, and are garnished with glaucous-green foliage; tall spikes of flowers, crowded in dense racemes. The flowers are one inch across and nearly two inches long, including the spur, and present a clear cream color with large orange yellow spot on the lower lip. As the plants last a long time in bloom, we can confidently recommend the long stemmed flower spikes for cutting. Per pkt., 35c.; 75c. per large pkt.

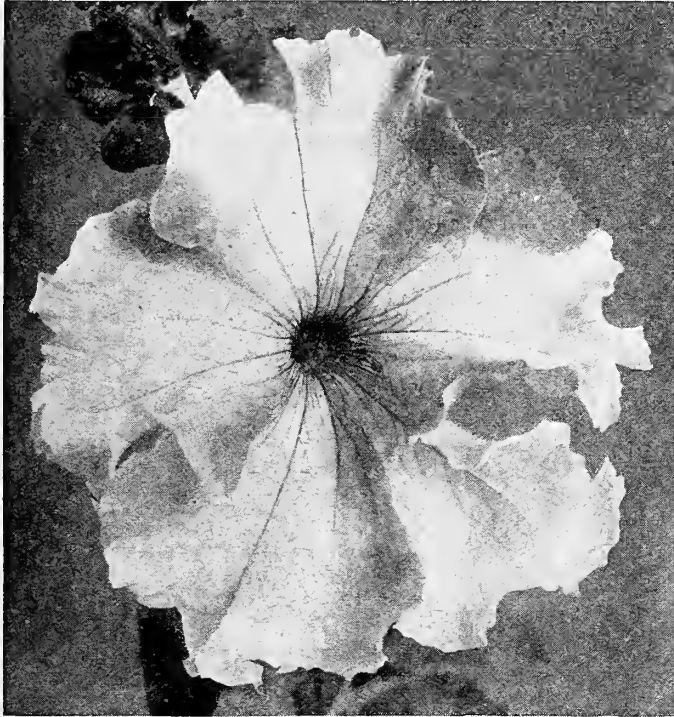

Portland Petunia

PORTLAND PETUNIAS

This new strain of Petunias was grown for us by a specialist, seed bearing plants being raised in balcony boxes and flowers artificially pollinated. For planting of veranda boxes and for choice potted plants or for bedding out these Petunias, in select colors, never fail to please. With these Petunias the choicest seedlings are generally the slowest to develop, and the most rapid growers and earliest blooming seedlings usually are of inferior type.

Elks Pride. Deep, royal purple flowers of large size; free grower. Per pkt., 40c.; \$1.25 per large pkt.

Irvington Beauty. A free blooming dwarf type, with peach blossom colored flowers of good size, with fringed edges and distinct white throat. Excellent for pots or bedding. Per pkt., 40c.; \$1.25 per large pkt.

Pride of Portland. Large, deep rose pink fringed flowers, with whitish yellow throat; fine for pots or box planting. Per pkt., 40c.; \$1.25 per large pkt.

Scarlet Beauty. A strong grower with medium sized fringed flowers; color, shading from cherry red to deep maroon towards the center. Per pkt., 40c.; \$1.25 per large pkt.

White Beauty. Fine pure white flowers in greatest profusion; good sized flowers with fringed edges. Excellent for veranda box planting. Per pkt., 40c.; \$1.25 per large pkt.

LARGE FLOWERING PETUNIA "MICHELL'S MONSTROSUS"

A great acquisition to the list of Large Flowering Petunias, surpassing the well-known Giants of California. The flowers are extremely large, quite a number of which are elegantly fringed; the colorings, markings, veinings, blotches, etc., are superb; many of them having deep throats of various shades. Per pkt., 25c.; 85c. per large pkt.

MYOSOTIS (Forget-Me-Not) MICHELL'S WINTER FLOWERING

The finest variety for winter flowering; handsome, large deep blue flowers produced on long stems, in great profusion. Sow seed in cold frame in June and transplant to a cool house for winter blooming. Per pkt., 15c.; 75c. per large pkt.

POPPY, American Legion

This new single poppy of the Shirley type is a dazzling orange-scarlet of immense size, borne on long, stout stems. The plants are of erect robust growth and the flowers are good keepers when cut in bud. Per pkt., 15c.; 40c. per large pkt.

FLANDERS POPPY

"In Flanders fields the poppies blow

Between the crosses row on row."

We are pleased to offer seed of this poppy, made famous in the song and story of the great war. For color effect there is nothing more brilliant than a bed of these crimson poppies. Per pkt., 10c.; 30c. per large pkt.; per oz., 75c.

PRIMULA OBCONICA GIGANTEA MONSTER STRAIN

An extra large flowering type of this popular Primula, which are great favorites for house and conservatory decorations. Seeds grown for us by a specialist.

	Large pkt.	Pkt.
Apple Blossom. Soft pink.....	\$1.25	\$0.40
Kermesina. Deep crimson.....	1.25	.40
Plathii. Brilliant deep rose.....	1.25	.40
Rosea. Pink.....	1.25	.40
Mixed Colors.....	1.25	.40

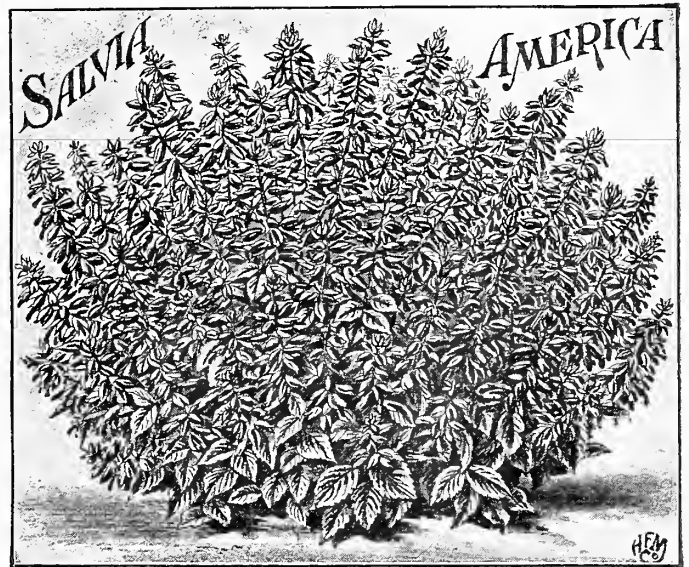

SALVIA (Scarlet Sage) AMERICA OR GLOBE OF FIRE

Of dwarf, bushy, compact growth, and very uniform in height and shape. A free and continuous bloomer, and produces large spikes of brilliant scarlet flowers. We consider this variety an improvement over any other dwarf Salvia. Per pkt., 25c.; 75c. per large pkt.; per ¼ oz., \$2.00.

SCHIZANTHUS GARAWAY'S HYBRIDS

A grand strain; plants grow about 2 feet high, with fern-like foliage and bearing a profusion of large flowers, all with handsome markings on a white, buff, brilliant rose, rich blue or purple ground. If seed is sown in February plants will bloom in summer, and if sown in May or June will make handsome subjects for the conservatory in winter. Per pkt., 25c.; 75c. per large pkt.



New Giant Dahlia Flowered Zinnia

ZINNIA

NEW GIANT DAHLIA FLOWERED

This splendid new and distinct race is without a doubt the greatest improvement in Zinnias yet developed and will greatly increase the popularity of this flower. The plants are of strong, vigorous habit, from 2½ to 3 feet high, and produce mammoth flowers 4 to 6 inches across and 2½ to 3 inches deep. The broad petals are closely imbricated, sometimes seeming almost to be piled one upon the other, the flowers so closely resembling decorative Dahlias, that when placed by their side, it is difficult to distinguish one from the other. This new variety is also valuable for growing under glass for cutting. We are pleased to be able to offer our customers this season this new strain in separate colors.

Large pkt. Pkt.

- Crimson Giant.** By far the largest and best of the red shades; plants very vigorous. \$0.75 \$0.25
- Dream.** A fine, deep lavender turning to purple, a new, desirable shade in Zinnias.75 .25
- Exquisite.** One of the most pleasing in the collection; truly Dahlia-flowered as regards form and size; color, light rose, with deep rose centre.75 .25
- Golden State.** A very rich orange yellow; yellow in the bud, turning to an attractive orange when in full bloom.75 .25
- Old Rose.** A very desirable shade; flowers large and of fine form.75 .25

Large pkt. Pkt.

- Oriole.** One of the most beautiful of its class; an immense orange and gold bicolor, changing slightly as it ages, but at all times worthy of the beautiful bird for which it was named. \$0.75 \$0.25
- Polar Bear.** A very large pure white; the best white yet seen in Zinnias.75 .25
- Scarlet Flame.** A large, beautiful bright scarlet, with a delightful blending of orange throughout the petal.75 .25
- Mixed Colors.** A well blended mixture, covering a wide range of colors and shades.60 .15
- Collection.** One packet each of above 8 separate varieties for \$1.50.

DOUBLE PICOTEE ZINNIAS

The flowers of this class, while not as large as the Double Giants, are very effective in appearance, as the edges of the petals are all well marked with a distinct color to the body of the flower, making them very attractive as bedders and cut flowers.

Large pkt. Pkt.

- Golden Pheasant.** Color, gold ground, each petal tipped with maroon. \$0.75 \$0.25
- La France.** A beautiful, soft pink, each petal distinctly tipped with deep chocolate markings.75 .25
- Mixed.** All colors, including new colors from white to scarlet.60 .25

MICHELL'S DISTINCTIVE FLOWER SEEDS.



Our flower seeds have a reputation for their superior quality and for the excellent results obtained by sowing them. It is our constant endeavor to supply only such varieties and strains that will give the best of satisfaction.

Throughout the following pages of Flower Seeds the different varieties are designated as Annuals, Biennials, Perennials, etc., and for the benefit of those who are not familiar with these terms, we wish to make the following brief explanation:

Annuals. These grow and bloom, mature their seed and then die in the same year, such as Asters, Balsams, Poppies, Sweet Peas, Morning Glories, etc., some of which may be sown in the house from March to May, or outdoors after danger from frost is over.

Biennials. These grow from seed sown during mid-summer, flowering the second year, after which they die; many of the varieties bloom the first season if sown early. In this class we have Pansies, English Daisies, Campanula Medium, Dianthus, etc.

Perennials. Those which live from year to year, such as Aquilegia, Delphinium, Foxglove, etc. Seed may be sown outdoors from June to September and transplanted late in fall into their permanent quarters, and protected during winter with a light litter of straw or leaves. The hardy perennials not usually needing any protection after the first winter; the half-hardy perennials require protection during the winter, and the tender perennials during the winter require greenhouse protection.

A COMPLETE INDEX OF FLOWER SEEDS WILL BE FOUND ON PAGES TWO AND THREE OF CATALOG. FOR NOVELTIES, SEE PAGES 52 TO 56.

ABUTILON (Flowering Maple)

Large Pkt. Pkt.

Choice Mixed. Used extensively for ornamental bedding; also valuable for flowering indoors during the winter; seed should be started in heat from January till March; foliage is of maple form and has variegated coloring; flowers bell-shaped; height, 3 feet. . . \$0.60 \$0.10

ACHILLEA (Milfoil or Yarrow)

Ptarmica, Fl. Pl., "The Pearl." Tall erect plant bearing its pure white double flowers in great profusion all summer; hardy perennial; easily grown from seed; flowering the first season if seed is sown early; excellent cut flower for vases; 2 feet. 75 .10

ACONITUM (Monk's Hood or Helmet Flower)

Handsome hardy perennial, thriving best in semi-shady situations; effective in hardy borders, shrubberies, etc.; curious hood-shaped flowers in clusters; height, 4 feet; August-September.

Large Pkt. Pkt.

Napellus. Blue. \$0.40 \$0.10

ACROCLINIUM (Everlasting Flower)

See page 72

AGROSTEMMA

Coronaria (Mullein Pink). Silvery foliage and bright crimson flowers; free-flowering hardy perennial of easy culture; blooms the first season; fine for cutting; 2½ to 3 feet; June to August. 25 .10

Testimonial

Bloomington, Ind.

Please find enclosed order for Flower and Vegetable Seeds. We had the finest Asters last year from your seed we have ever grown. F. L. M.

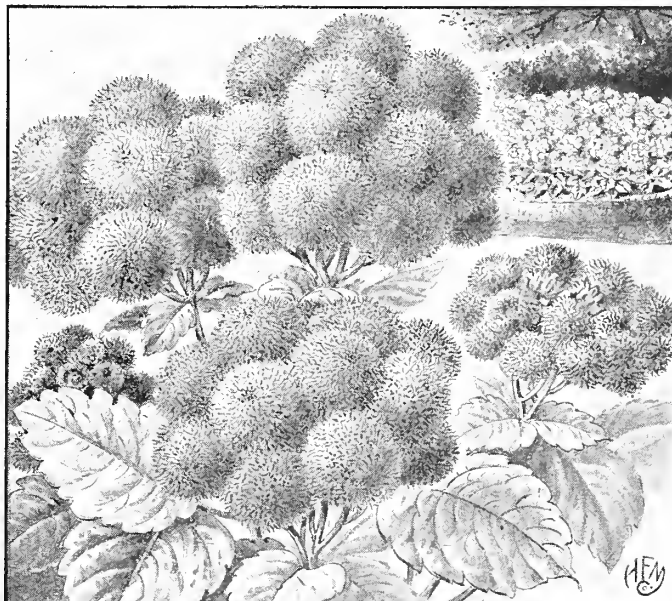

Ageratum, Blue Perfection

AGERATUM (Floss Flower)

An excellent plant for edging or solid effects. For early bloom sow indoors from March till May; sown outdoors in May will flower in August. A continuous bloomer.

Large Pkt. Pkt.

- Blue Perfection.** Large heads of deep blue flowers produced in abundance; 15 inches. \$0.25 \$0.10
- Imperial Dwarf Blue.** Clear blue; compact growing plant; height, 9 inches.25 .10
- Imperial Dwarf White.**25 .10
- Imperial Dwarf Mixed.**25 .05
- Little Blue Star.** Plants densely covered with bright blue flowers; height, 5 inches.60 .15



Sweet Alyssum

ALYSSUM

One of the most popular garden flowers, remaining in bloom the entire season; it is of the easiest culture, and is suitable alike for beds and edging in summer, or for growing in pots and boxes for winter blooming.

- | | | |
|---|------------|--------|
| | Large pkt. | Pkt. |
| Lilac Queen. A distinct variety of dwarf, compact growth, with flowers of a pure lilac color; 4 inches. | \$0.25 | \$0.10 |
| Little Dorritt. Extremely dwarf and compact, forming perfect little bushes with miniature white flowers; ideal for narrow edges. | .25 | .10 |
| Little Gem. Dwarf compact plants, densely covered with large white flowers; commences to bloom when quite small; height, 4 inches. | .25 | .10 |
| Mitchell's Bouquet (New). Plants dwarf and compact; forms a perfect bouquet of miniature white flowers; a perfect gem for edging. For illustration and full description, see page 52. | .60 | .15 |
| Sweet (Maritimum). The popular old-fashioned sort; the best for broad edges and vases. Pure white; height, 6 inches. | .25 | .05 |
| Saxatile Compactum (Basket of Gold). An ideal hardy perennial plant, flowering in May; showy golden-yellow flowers; blooms the first season if sown early indoors; excellent for rockwork. Height, 1 foot. | .30 | .10 |

AMARANTHUS

Decorative foliage plants, easily raised from seed, either by starting them early indoors or sown outdoors in May. Useful in borders of tall plants or for the centre of large beds.

- | | | |
|--|------------|--------|
| | Large pkt. | Pkt. |
| Caudatus (Love Lies Bleeding). Long drooping crimson racemes; height, 3 feet. | \$0.25 | \$0.10 |
| Sunrise. Foliage bronzy crimson, tipped carmine. | .40 | .10 |
| Tricolor Splendens (Joseph's Coat). Foliage green, variegated crimson and yellow; height, 2 feet. | .25 | .10 |
| Mixed. All sorts. | .25 | .05 |

AMPELOPSIS (Boston or Japanese Ivy)

Veitchi. A hardy perennial climber with olive-green leaves, which turn to scarlet in the autumn. The best hardy vine for covering brick or stone buildings or walls.

ANCHUSA (Sea Bugloss)

Italica "Dropmore." A very popular strong growing hardy perennial plant, 4 feet high, with an abundance of beautiful flowers of a lovely gentian blue, borne on graceful stems, during the entire season; 3 to 4 ft.

ANEMONE (Wind Flower)

- | | | |
|---|-----|-----|
| Coronaria. Mixed colors. A pretty, hardy perennial, producing large flowers; excellent for bouquets; 1 foot. | .25 | .05 |
| St. Brigid or Poppy. Flowers large, semi-double and double; in many colors; 1 foot. | .50 | .15 |

ANTHEMIS (Hardy Marguerite)

Tinctoria Kelwayi. A handsome, hardy perennial, bearing all summer, daisy-like bright yellow flowers; excellent for cutting; 2 feet.



Mitchell's Giant Antirrhinum (Snapdragon)

ANTIRRHINUM (Snapdragon)

A splendid plant for beds or borders and one of our choicest cut flowers; extensively forced under glass during the winter. To have flowers early, sow indoors during February or March, but even if sown outdoors early in May it will bloom in July.

MICHELL'S GIANT ANTIRRHINUMS

Spikes, 2 to 3 feet in length, with giant flowers.

- | | | |
|--|------------|--------|
| | Large pkt. | Pkt. |
| Mitchell's Giant Salmon Pink. Long spikes of flowers of a delicate salmon pink color. | \$0.60 | \$0.15 |
| Keystone. Long spikes; color, rose pink. | | 1.00 |
| Silver Pink. | | 1.25 |
| Giant Canary Bird. Canary yellow. | .60 | .25 |
| Giant Cattleya (New). Silver rosy lilac, golden lip. | .60 | .25 |
| Giant Garnet. | .30 | .10 |
| Giant Golden Pink Queen (New). | | 1.25 |
| Giant Philadelphia Pink (New). See page 52. | | 1.25 |
| Giant Pink. | .30 | .10 |
| Giant Scarlet. | .30 | .10 |
| Giant Snowflake. Pure white. | .60 | .25 |
| Giant Striped. | .30 | .10 |
| Giant Venus. Shell pink on white ground. | .50 | .15 |
| Giant White. | .30 | .10 |
| Giant Yellow. | .30 | .10 |
| Collection, one packet each six colors, 50c. | | |
| Giant Mixed. All colors. | .30 | .10 |

ANTIRRHINUMS—Various Sorts

The Semi-Dwarf sorts grow about 18 inches high, with large flowers over most of the stem; excellent for bedding.

- | | | |
|--|------------|--------|
| | Large pkt. | Pkt. |
| Semi Dwarf. Bride. Pure white. | \$0.40 | \$0.10 |
| “ Daphne. Carmine pink, white throat | .30 | .10 |
| “ Defiance. Fiery scarlet. | .30 | .10 |
| “ Firebrand. Rich deep red. | .30 | .10 |
| “ Golden Queen. Golden yellow. | .30 | .10 |
| “ Mont Blanc. Pure white. | .30 | .10 |
| “ Nelrose. Pink. | .60 | .25 |
| “ Rose Queen. Rich rose. | .30 | .10 |
| “ Mixed. All colors. | .30 | .10 |
| Tall Mixed. Regular strain. | .25 | .05 |
| Tom Thumb Mixed. All colors; 12 inches. | .30 | .10 |



Aquilegia (Columbine) Long Spurred

AQUILEGIAS OR COLUMBINES

These are among the most beautiful of spring and early summer flowers; very effective when grown in the herbaceous border and groups among shrubbery. Graceful spurred flowers on stems 2 feet or more above the foliage. Seed sown early in the spring will in most cases produce plants that will bloom the same season.

Large pkt. Pkt.

- Californica Hybrida.** Mixed colors, principally yellow and orange shades; long spurs. \$0.50 \$0.10
- Chrysantha (Golden Spurred).** Bright golden yellow.60 .10
- Coerulea (Rocky Mountain Columbine).** Large flowers, violet blue and white.50 .10
- Long Spurred Hybrids.** Flowers of many rich and varied colors, with long spurs.50 .10
- Rose Queen.** Light to dark pink with white centre and yellow anthers.60 .15
- Double Mixed.** All colors. oz., 75c. .25 .05
- Single Mixed.** All colors. oz., 60c. .25 .05

ARABIS (Rock Cress)

Alpina. Early spring flowering plants especially adapted for edging and rockery; plants form a dense carpet completely covered with pure white blossoms; perennial; April-May; 6 inches.25 .10

ARCTOTIS (African Daisy)

Grandis. Bushy annual plants, producing the entire season, on long stems, large daisy-like flowers, pure white on the upper surface, the reverse side of petals lilac-blue; 2 feet.25 .10

MICHELL'S CULTURAL LEAFLETS

We have prepared the following Cultural Leaflets especially for the benefit of the amateur, or, in fact, for any who may want them, giving instructions how to grow the varieties named successfully from seed. These leaflets are free.

- 201. Antirrhinum. 208. Zinnia. 215. Cyclamen.
- 202. Aster. 209. Pansy. 216. Larkspur
- 203. Cineraria. 210. Salvia. (Annual).
- 204. Mignonette. 211. Stock. 217. Lupinus.
- 205. Petunia. 212. Perennials. 218. Phlox Drum.
- 206. Primula. 213. Carnation. 219. Nasturtium.
- 207. Verbena. 214. Cosmos. 220. Begonia.

ARTEMISIA

Sacrorum Viridis

(*Summer Fir*). A new ornamental foliage plant from China; pyramidal bushes 3 to 5 feet high; may be grown in groups and borders; also pretty as a pot plant; foliage fine and of a rich dark green. Plants cultivated in the open ground may be successfully planted in pots without any interruption of their growth. Per pkt., 15c.; 30c. per large pkt.



Artemisia, Sacrorum Viridis

ARUNDO
(Ornamental Grass)
See Page 74

ASPARAGUS

100 Seeds. Pkt.

- Plumosus Nanus.** An excellent plant for house or conservatory decoration or cutting on account of its graceful, finely cut foliage; will remain fresh a long time after being cut. \$1.00 \$0.25
- Sprengeri.** One of the best plants to grow in hanging baskets or window boxes for the greenhouse in winter or for outdoors in the summer.50 .10

ASPERULA (Woodruff)

Large pkt. Pkt.

Odorata. A pretty hardy perennial plant thriving in partial shade; flowers white. The leaves and flowers when dried have an odor like new mown hay and when laid among clothes perfume them and keep away insects; 1 ft.; May. \$0.40 \$0.10



Arctotis Grandis (Large pkt. 25c.)

MICHELL'S SUPERB ASTERS

We can imagine no other flower which combines so much beauty with grace and usefulness and with which more brilliant effects can be achieved. From July till September this flower reigns supreme in the garden, not equaled by any other. For these obvious reasons we give a great deal of attention to these flowers, and are in a position to offer our patrons remarkably fine strains, producing perfect flowers of great beauty. Many of the strains we offer are grown under our own supervision by specialists in this country. To have early flowers, sow the seed in the house, hotbed or cold frame, from March till May; otherwise sow outdoors after danger from frost has passed. To do well, Asters require a well-pulverized soil, always kept open by continuous cultivation.

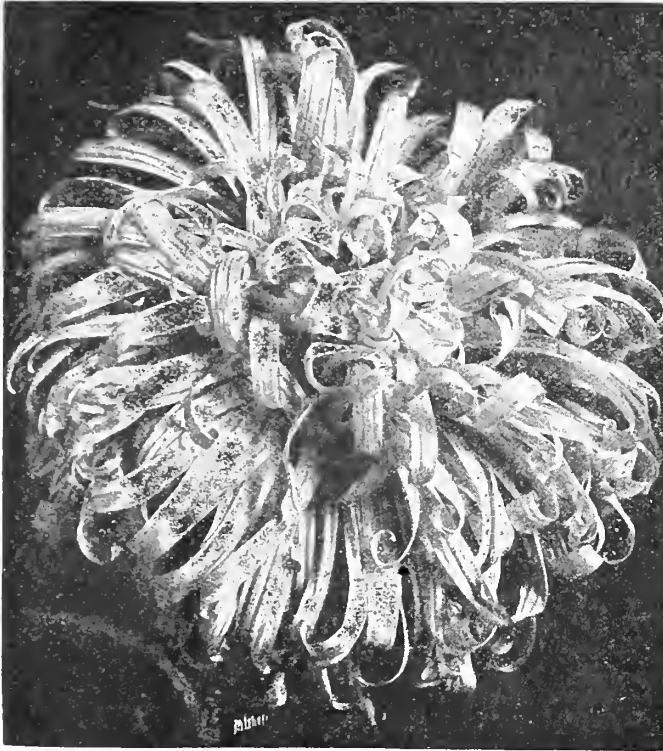

Asterum

ASTERMUM

A valuable variety of Aster of the Comet type, coming into bloom in mid-season; plants grow straight up with strong, sturdy stems, and may be set more closely than other varieties. Each plant yields from ten to fifteen blooms.

	Oz.	Large pkt.	Pkt.
Lavender	\$2.25	\$0.50	\$0.15
Rose Pink	2.25	.50	.15
Shell Pink	2.25	.50	.15
White	2.25	.50	.15
Mixed	2.25	.50	.15
Collection, one pkt. each of above 4 colors ..			.50

CALIFORNIA GIANT ASTERS

For illustration see page 53.

A new variety with flowers of the Crego type, and with the habit of growth and long stems of the Beauty type. Flowers large and stand up well after being cut. Their immense size and beauty, as well as their long stems make them very attractive.

Large pkt.	Pkt.	Light Blue	Large pkt.	Pkt.
Dark Purple	\$0.75	\$0.25	\$0.75	\$0.25
Deep Rose75	.25	Peach Blossom ..	.75 .25
Collection, one pkt. each of above 4 colors, 85c.				

GIANT COMET ASTER

A flower of exquisite form and resembling Japanese Chrysanthemums; petals are curled downward at the tips.

	Oz.	Large pkt.	Pkt.
Carmin Rose	\$2.25	\$0.50	\$0.10
Crimson	2.25	.50	.10
Dark Blue	2.25	.50	.10
Light Blue	2.25	.50	.10
White	2.25	.50	.10
Choice Mixed	2.00	.50	.10
Collection, one pkt. each of above 5 colors ..			.40

DAYBREAK ASTERS

The Daybreak class forms strong plants of upright, bushy habit and are very profuse bloomers; excellent for beds or borders; flowers perfectly double and carried on long, erect stems.

	Oz.	Large pkt.	Pkt.
MicHELL's Purity (<i>White Daybreak</i>). Very free flowering; plants are literally one mass of snow-white flowers	\$3.50	\$0.60	\$0.10
Pink Daybreak. Flowers large, double and of a delicate pink	3.50	.60	.10

EARLY WONDER ASTER

The earliest variety in cultivation, coming into bloom several days before "Queen of the Market." The form is that of "Giant Comet" type; the flowers are large and very double; stems average 18 inches in length.

	Oz.	Large pkt.	Pkt.
Dark Blue	\$3.00	\$0.60	\$0.10
Pink	3.00	.60	.10
White	3.00	.60	.10

HEART OF FRANCE ASTER

The flowers are large and full to the centre; opens ruby red, deepening with age. Plants are of branching type; flower stems long. See page 53 for illustration and full description. Per pkt., 25c.; 60c. per large pkt.; oz., \$3.50.

LADY ROOSEVELT ASTER

The flowers resemble huge incurved Chrysanthemums; the color is a gorgeous pink, of marvelous beauty. The robust plants produce stout stems, crowned with gigantic flowers. Per pkt., 15c.; 75c. per large pkt.; oz., \$3.50.



Pink Superb Aster (Large pkt. 75c.)

MICHELL'S PINK SUPERB ASTER

The flowers are of immense size, petals long and broad; those in the centre lie curled and incurved, completely covering the crown; the general appearance of the flower being that of an immense flat Chrysanthemum; color, a beautiful shade of pink. An excellent sort for cutting. Per pkt., 25c.; 75c. per large pkt.; oz., \$3.50.



ASTER, AMERICAN BEAUTY

This variety is similar in type of flower and growth to the well-known Late Branching Asters, but differs in that all the large blossoms are produced on much longer and heavier stems. Plants will average two and one-half to three feet in height, according to location, while the immense flowers, usually four to five inches in diameter, are often borne on heavy stems which may be cut two feet in length. The flowers are fully double to the last. Each plant forms a perfect bush.

	Large Pkt.	Pkt.
Azure Fairy.....	\$0.75	\$0.15
Carmine Rose.....	.75	.15
Crimson.....	.75	.15
Lavender.....	.75	.15
Shell Pink.....	.75	.15
White.....	.75	.15
Collection, one packet each of above 6 colors, 75c.		

MICHELL'S INVINCIBLE ASTER

Healthy, robust plants of branching growth, producing on 2-foot long stems, massive, well-formed flowers, which are always perfectly double. These Asters are wonderfully prolific and continuous bloomers from summer until frost.

	Oz.	Large Pkt.	Pkt.
Blue.....	\$2.25	\$0.50	\$0.10
Crimson.....	2.25	.50	.10
Lavender.....	2.25	.50	.10
Rose Pink.....	2.25	.50	.10
White.....	2.25	.50	.10
Mixed. All colors.....	2.00	.50	.10
Collection, one packet each of above 5 colors.....			.40

LAVENDER GEM ASTER

A beautiful variety of the Comet type, with large, perfectly double flowers of a delicate shade of lavender; begins blooming in July, continuing through August; 2 feet. Per pkt., 15c.; 60c. per large pkt.; per oz., \$3.00.

CREGO ASTER

Our illustration can do but partial justice to this grand flower. The twisted and curled petals give the flower the appearance of a huge chrysanthemum. The flowers are very large, often measuring 5 inches in diameter. The strong, erect stems average 20 to 24 inches in length. Though the flowers are large they are produced in abundance.

	Oz.	Large Pkt.	Pkt.
Azure Blue.....	\$2.25	\$0.50	\$0.10
Lavender.....	2.25	.50	.10
Purple.....	2.25	.50	.10
Rose Pink.....	2.25	.50	.10
Shell Pink.....	2.25	.50	.10
White.....	2.25	.50	.10
Mixed.....	2.00	.50	.10
Collection, one packet each of above 6 colors.....			.50



CHINA ASTERS

Choice Mixed. A general mixture containing many classes and colors. Pkt., 5c.; 25c. per large pkt.; per oz., 75c.

PEERLESS ASTER

This is one of the finest of the late branching types, but comes into bloom a little earlier. The plants are of robust, free-branching habit, and produce on long stems, large and perfectly double flowers.

	Large Pkt.	Pkt.
Yellow. Pure sulphur.....	\$0.75	\$0.25

See pages 52 and 53 for novelties and specialties in Asters.



MICHELL'S SUPERB ASTERS KING ASTERS

A distinct type; plants are of strong, sturdy habit, fully 18 inches high; the flowers are of large size and good substance, and with long narrow petals, which are more or less quilled, forming a very attractive flower.

	Oz.	Pkt.	Pkt.
Crimson King. Rich deep crimson.....	\$2.50	\$0.60	\$0.15
Lavender King. Pale lavender.....	2.50	.60	.15
Pink King. Delicate shell pink.....	2.50	.60	.15
Purple King. A rich shade.....	2.50	.60	.15
Rose King. Beautiful, bright rose.....	2.50	.60	.15
Violet King. A soft shade of violet.....	2.50	.60	.10
White King. Large, pure white.....	2.50	.60	.15
Mixed King.	2.50	.60	.10
Collection, 1 packet each of above 7 colors			.85

MICHELL'S IMPROVED SEMPLER'S BRANCHING ASTER

This is the finest late blooming Aster. The deep, heavy incurved flowers are borne on rigid stems often 2 feet and more in length. Our Improved Strain has been secured after many years of careful selection. The colors are clear and attractive, which, with the long stems, makes it one of the most valuable varieties for cutting. We have received numerous testimonials on the quality of this Aster.

	Oz.	Pkt.	Pkt.
Crimson.	\$2.25	\$0.50	\$0.10
Lavender	2.25	.50	.10
Purple	2.25	.50	.10
Rose Pink	2.25	.50	.10
Shell Pink	2.25	.50	.10
White	2.25	.50	.10
Choice			
Mixed.	1.75	.50	.10
Collection, one pkt. each of above 6 colors			.50

ASTER, VICK'S SILVERY ROSE

A long-stemmed, large-flowering variety; each petal is a combination of deep lilac rose, almost cerise, delicately threaded with white. The threads are so tiny as to give the petals a silvery sheen; even the slightest change in light will shade the petals from a rich, glowing rose cerise to a silvery rose. Pkt., 25c.; 75c. per large pkt.

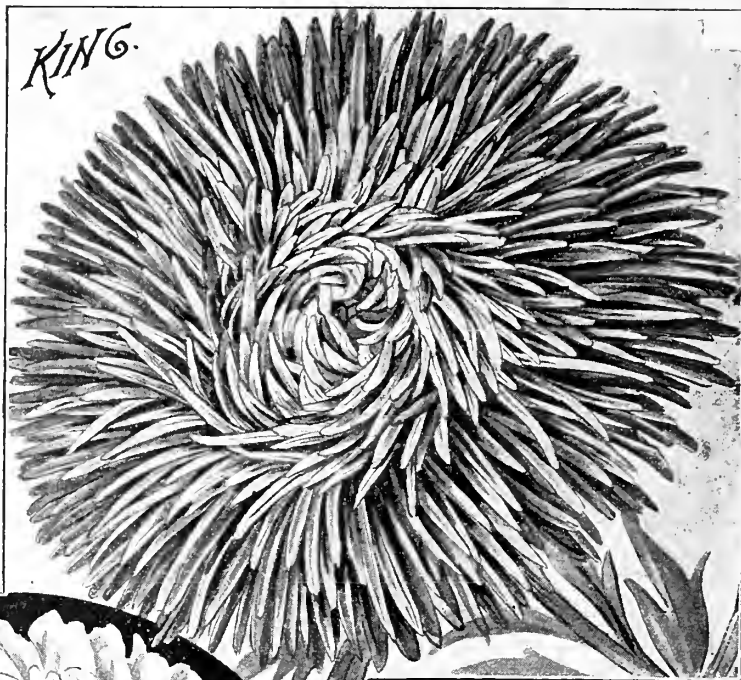

QUEEN OF THE MARKET ASTER

Very desirable on account of its earliness and the freedom in which it flowers. Well-formed flowers are produced on 12-inch stems in the greatest profusion early in July.

	Oz.	Pkt.	Pkt.
Blush Pink.	\$1.50	\$0.40	\$0.10
Crimson.	1.50	.40	.10
Dark Blue.	1.50	.40	.10
Light Blue.	1.50	.40	.10
Rose Pink.	1.50	.40	.10
White.	1.50	.40	.10
Choice Mixed	1.25	.30	.10
Collection, one packet each of above 6 colors			.50

PACIFIC BEAUTY ASTER

A new variety of the same type as Crego, producing a profusion of immense blooms of a rich lavender color. The petals are wide and long and gracefully curled. See illustration, page 52. Pkt., 25c.; 75c. per large pkt.; 1/4 oz., \$1.25.

ASTER, EARLY ROYAL BRANCHING

An excellent strain of Early Branching Aster, of the same form and having the same good qualities as the Late Branching variety, coming into bloom in July or early August and lasting in perfect condition for a long time. Very desirable for beds or borders, and an excellent variety for cutting.

	Oz.	Pkt.	Pkt.
Lavender.	\$2.50	\$0.60	\$0.10
Purple	2.50	.60	.10
Rose Pink.	2.50	.60	.10
Shell Pink.	2.50	.60	.10
White.	2.50	.60	.10
Mixed.	2.25	.50	.10
Collection, one packet each of above 5 colors			.40

PERENNIAL ASTER (Michaelmas Daisy)

Choice Mixed. One of the showiest of our late flowering, perennial plants; star-like, single flowers; if sown early in spring will flower the first season; 2 feet. \$0.40 \$0.10

AURICULA (Primula Auricula)

Choice Mixed. Beautiful low growing, early spring flowering plants; fine for borders, pot culture, etc.; have multi-colored flowers in great variety; half-hardy perennial; 6 inches; May.....\$0.75 \$0.10

AVENA (Ornamental Grass) (see page 74)

BABY'S BREATH (See Gypsophylla)

BACHELOR'S BUTTON (See Centaurea and Gomprena)

BALLOON VINE (Love-in-a-Puff)

A rapid growing annual climber; white flowers, followed by seed pods which look like miniature balloons. \$0.25 \$0.05

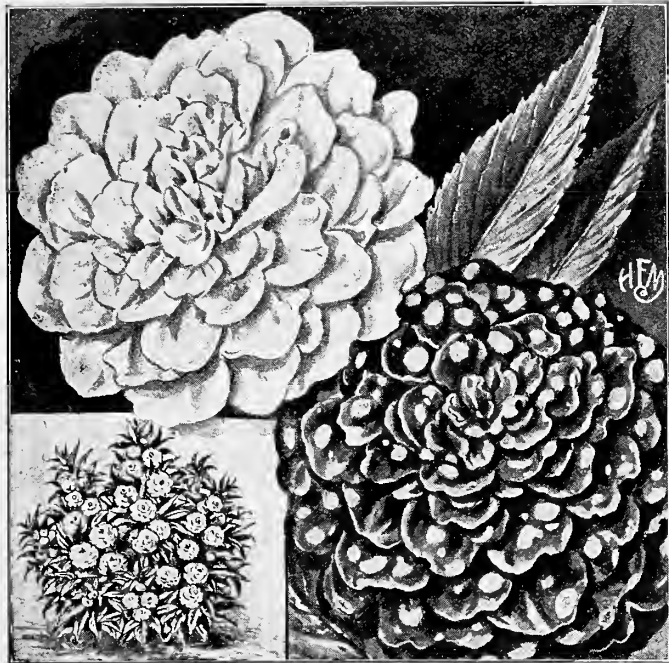

Camellia Flowered Balsam

DOUBLE BALSAM (Lady's Slipper)

These old-fashioned flowers have been much improved, and what we offer are perfect in form and of the largest size. Give Balsams plenty of room and they will develop to immense plants with gorgeous flowers. They are of easy culture and will surely succeed almost anywhere; height 2 feet.

	Oz.	Pkt.	Pkt.
Camellia Flowered, Pink.....	\$1.00	\$0.30	\$0.10
Camellia Flowered, Prince Bismarck. Rich salmon pink.....	1.00	.30	.10
Camellia Flowered, Scarlet.....	1.00	.30	.10
Camellia Flowered, White Perfection.....	1.50	.40	.10
Camellia Flowered, Choicest Mixed.....	.75	.30	.10
Fine Mixed.....	.50	.25	.05
Imported Collection of 6 Colors.....			.50

BALSAM APPLE (Momordica)

Remarkably handsome climbing annuals, bearing ornamental orange-colored fruit which when ripe opens, showing a brilliant crimson interior, oz., 50c. .25 .05

BAPTISIA (False Indigo)

Australis. A strong growing perennial plant about 2 feet high, with dark green, deeply cut foliage and spikes of dark blue, pea-shaped flowers in June and July..... .30 .10

BARTONIA

Aurea. A free blooming, showy annual plant with large golden yellow flowers of a metallic lustre; best adapted for partial shade and moist locations; 18 inches..... .25 .10

BEAN (Runner)

A rapid climber, flowering profusely; grows 10 to 15 ft. high. Scarlet. Per lb., 35c.; 65c. per 2 lbs.; pkt., 5c.



Begonia, Gracilis Luminosa

BEGONIA (Semperflorens Type)

The following varieties are unsurpassed for bedding plants, thriving equally well in partially shaded or sunny locations. As pot plants for winter flowering, they are superb. Seeds sown in February or March under glass will produce nice plants for planting out in June.

	Large pkt.	Pkt.
Erfordia. Delicate pink, one of the choicest.....	\$0.75	\$0.15
Salmon Queen. Flowers brilliant salmon red; foliage dark green, with reddish hue.....	.75	.20
Vernon. Deep red flowers and bronzy-red foliage..	.75	.20
Choice Mixed. All sorts and varieties.....	.75	.20

BEGONIA, GRACILIS

One of the finest outdoor flowering Begonias; plants are literally covered with flowers throughout the summer; height, 1 foot.

	Large pkt.	Pkt.
Gracilis Alba. Pure white.....	\$0.50	\$0.15
Gracilis Luminosa. Brilliant fiery dark scarlet; very bright.....	.60	.20
Gracilis Prima Donna. Rose, shading to carmine... .75 .20		
Gracilis Rosea. Light pink.....	.50	.15

BEGONIA, TUBEROUS ROOTED

These magnificent flowers are becoming very popular because they are of easy culture and extremely showy; thrive in semi-shady situations.

	Large pkt.	Pkt.
Double Choice Mixed		\$0.50
Single Choice Mixed	\$0.75	.15

BELLIS PERENNIS (See Daisy)

BLUE LACE FLOWER (See Didiscus)

See illustration, page 53

BOCCONIA (Plume Poppy)

Cordata. A splendid, hardy perennial, with glaucous green foliage, and bearing freely, spikes 2 to 3 feet long of creamy white flowers; 5 feet..... .25 .10

BRACHYCOME (Swan River Daisy)

Iberidifolia. A desirable hardy annual, blooming profusely the greater part of the summer; small blue flowers resembling those of the Cineraria; 9 inches..... .30 .10

BRIZA MAXIMA (Ornamental Grass) (See page 74)

BROMUS (Ornamental Grass) (See page 74)



BROWALLIA

One of our favorite bedding plants, producing beautiful flowers during the summer and autumn months; grows freely in any rich soil; blooms finely in the winter if the plants are lifted in the autumn and cut back; height, 18 inches. Large pkt. Pkt.

Elata Coerulea. Large sky-blue flowers.....\$0.30 \$0.10

Speciosa Major. Large flowers of brilliant ultramarine blue; does finely outside in the border but is especially desirable as a pot plant for winter and early spring flowering..... .75 .20

BUTTERFLY FLOWER (See Schizanthus)



Mitchell's Grandiflora Calceolaria

CALCEOLARIA

Excellent plants for decorating the green house or conservatory; produces a mass of pocket-like flowers through the spring and summer. Our strains of Calceolaria have a wide reputation as to large size and rich and varied colors of the flowers. Large

Hybrida Grandiflora, Tall Mixed. Large flowering, Pkt. Pkt. rich, self-colored flowers saved from a choice collection; 18 inches.....\$0.85 \$0.25

Hybrida Grandiflora Pumila Compacta. Of dwarf, compact robust growth, producing immense trusses of large and varied brilliant self-colored and spotted flowers; 1 foot..... .85 .25

Rugosa Mixed (Shrubby). Small flowering varieties for bedding..... .85 .25

CALIFORNIA POPPY (See Eschscholtzia)

CALLIOPSIS (Coreopsis)

One of the showiest and most easily grown annuals; perfect little bushes, which are a mass of bloom from early summer until cut down by frost; excellent for cutting.

	Oz.	Large Pkt.	Pkt.
Golden Wave (Drummondii). Large yellow flowers with dark brown centres; 1 foot...	\$0.40	\$0.25	\$0.10

Nigra Speciosa. Rich crimson; 2 feet.....	.40	.25	.10
--	-----	-----	-----

Choice Mixed. All varieties and colors.....	.40	.25	.05
--	-----	-----	-----

PERENNIAL VARIETIES

California Sunbeams. Very large flowers, beautifully formed; yellow and brown.....	.75	.25	.10
---	-----	-----	-----

Lanceolata Grandiflora. Single golden yellow flowers of graceful form; invaluable for cutting; blooms the entire summer.....	.50	.25	.10
---	-----	-----	-----

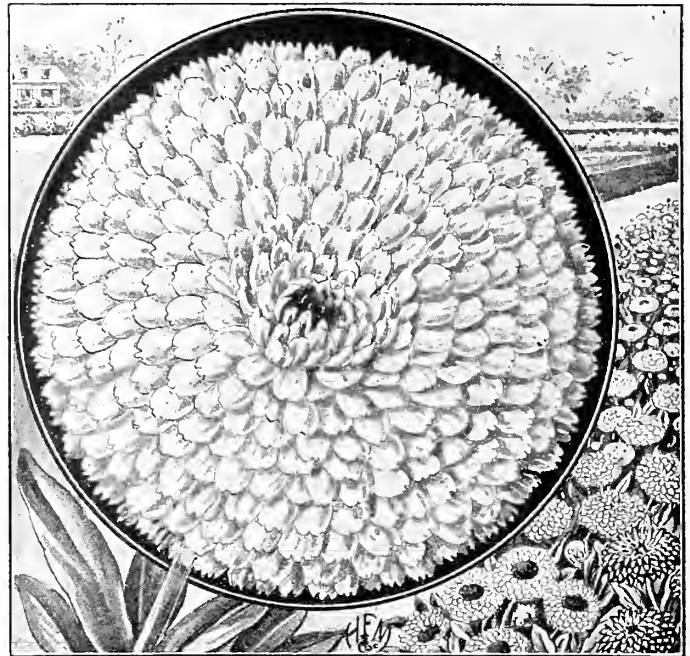

Calendula

CALENDULA (Pot Marigold)

Free flowering showy annuals of easy culture, producing a fine effect in beds or mixed borders; continues in bloom from early summer until killed by frost. Valuable for pot culture, blooming freely in winter and early spring; 1 foot.

	Oz.	Large Pkt.	Pkt.
Lemon King. Lemon-yellow.....	\$0.40	\$0.25	\$0.10
Meteor. Yellow striped orange.....	.40	.25	.10
Orange King. Rich dark orange.....	.40	.25	.10
Prince of Orange. Dark orange striped... ..	.40	.25	.10
Pure Gold. Pure golden yellow.....	.40	.25	.10
Sulphurea. Sulphur yellow.....	.40	.25	.10
Mixed.....	.40	.25	.05



Calliopsis, Golden Wave (Large pkt. 25c.)

CAMPANULA MEDIA (Canterbury Bell)

Showy, hardy biennial, growing about 3 feet high; of pyramidal form and covered with large bell-shaped flowers. Sow from June 1st till September 1st; when strong enough transplant to a distance of 6 inches apart; after frost has set in protect with leaves and straw. They flower the following summer, after which they die.

	Oz.	Pkt.	Pkt.
Single Blue.....	\$0.60	\$0.25	\$0.10
Single Pink.....	.60	.25	.10
Single White.....	.60	.25	.10
Single Mixed.....	.50	.25	.05
Double Blue.....		.50	.10
Double Pink.....		.50	.10
Double White.....		.50	.10
Double Mixed.....	1.50	.40	.10

CAMPANULA CALYCANTHEMA

(Cup and Saucer Canterbury Bells)

These produce beautiful, large single flowers, resembling a cup and saucer; very effective when grown in pots for conservatory decoration; they require the same treatment as above.

	Large pkt.	Pkt.	White.....	Large pkt.	Pkt.
Blue.....	\$0.50	\$0.10	White.....	\$0.50	\$0.10
Pink.....	.50	.10	Mixed, 1/4 oz., 60c.	.40	.10

CAMPANULAS OR BELLFLOWERS

(Perennial Varieties)

These are among our best known hardy perennials, and deserve a place in every perennial flower garden. The tall varieties are fine for cutting, while the dwarf sorts make excellent border plants; all have dainty bell-shaped flowers.

	Large pkt.	Pkt.
Carpatica, Blue (Carpathian Hare Bell). Compact tufts not exceeding 8 inches; flowers clear blue, held erect; blooms in June and July.....	\$0.30	\$0.10
Carpatica, Alba. Pure white.....	.30	.10
Persicifolia Grandiflora, Blue (Peach Bells). Stately spikes, 4 feet tall, with immense blue bell-shaped flowers.....	.75	.15
Persicifolia Grandiflora, Alba. Pure white.....	.75	.15
Pyramidalis (Chimney Bellflower). Perfect pyramids 6 ft. high, crowded with large bell-shaped flowers, blue and white mixed.....	.40	.10

CANARY BIRD VINE

(Tropaeolum Canariense)

One of the most charming annual climbers, bearing hundreds of pretty, fringed, bright yellow flowers, which resemble a canary bird with expanded wings...oz., 50c. .25 .05

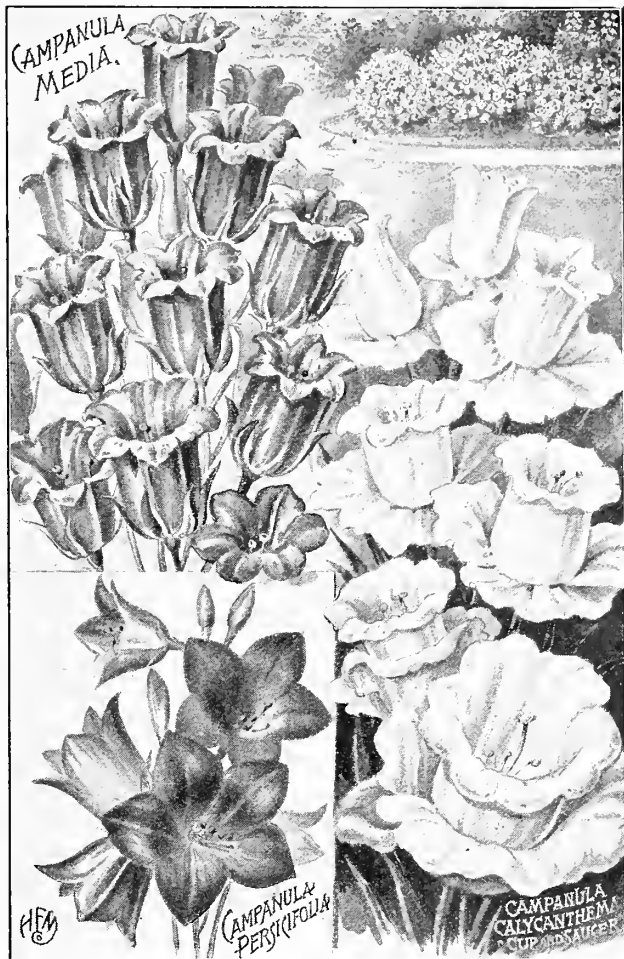

Campanulas

CANDYTUFT (Iberis)

Dwarf, profuse flowering garden annuals of easy culture; useful for bedding or borders; blooms within six weeks after sowing; excellent for cutting; height, 1 foot.

	Oz.	Large Pkt.	Pkt.
Carmine	\$0.40	\$0.25	\$0.10
Crimson40	.25	.10
Empress. An excellent variety with long trusses of pure white flowers.....	.40	.25	.10
Lavender40	.25	.10
Little Prince. Very dwarf and compact, with pure white flowers; excellent for edging.....	.50	.25	.10
Michell's Giant White. The largest and finest white. From 10 to 12 immense spikes resembling Hyacinths appear on a single plant; fine for forcing.....	.75	.25	.10
Pink50	.25	.10
Purple. Deep rich purple.....	.40	.25	.10
Choice Mixed. All colors.....	.25		.05
Collection. One packet each, 6 colors.....			.50
Sempervirens. Dwarf spring flowering perennial plants; ideal for the bulb border; flowers of glistening white; May; 1 foot.....		.60	.10

CANNA (Indian Shot)

Although these are generally planted from roots, they may be grown with comparative ease from seed. Scrape or file the edge of seed and soak in warm water until they show signs of swelling, then sow in sandy loam and place in a hotbed.

	Oz.	Pkt.
Crozy's Dwarf Mixed. From the finest sorts.....	\$0.30	\$0.10

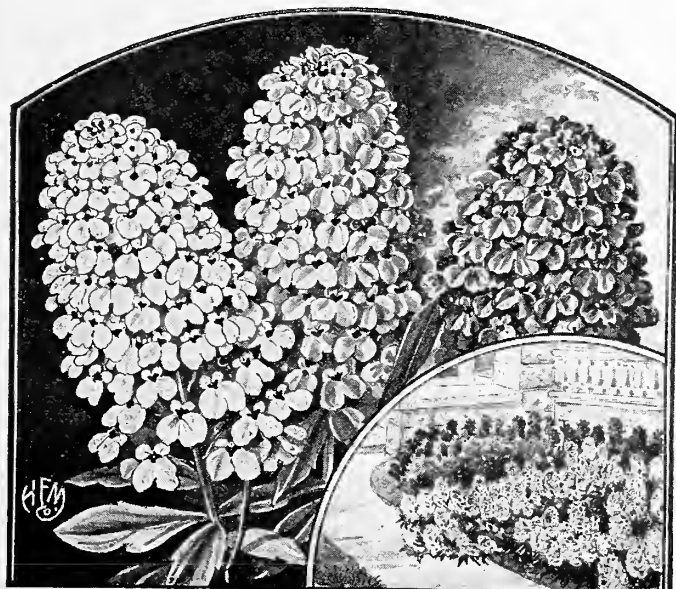

Candytuft, Michell's Giant White



CANTERBURY BELL (See Campanula)



MICHELL

Carnation, Marguerite

CARNATION

These are general favorites for their richness of color and delightful fragrance; they are desirable for greenhouse culture in winter as well as for the garden in summer.

	Large pkt.	Pkt.
Chaubaud's Everblooming, Mixed. Blooms in five months after being sown, and continues to flower in the greatest profusion indefinitely	\$0.60	\$0.15
Early Vienna. Large double flowers in mixture	.50	.10
Choice Mixed. Double border varieties	.60	.10

MARGUERITE CARNATIONS

These are the most satisfactory of the annual pinks, and will bloom in four months after sowing the seed. The flowers are large, fragrant and are produced continuously. If slightly protected they will survive an ordinary winter and bloom the following spring.

	Large pkt.	Pkt.
Excelsior Mixed. Extra large flowers	\$0.50	\$0.15
Pink	.50	.10
Scarlet	.50	.10
White	.50	.10
Yellow	.50	.10
Choice Mixed	.oz., \$1.50	.30

CASTOR BEAN (See Ricinus)

CELOSIA

Chrysanthe flora (New). Flowers in a great variety of colors. For illustration and full description see page 54.
Per pkt., 40c.; \$1.25 per large pkt.

CARDINAL CLIMBER (Ipomoea Quamoclit Hybrida)

A distinct and beautiful new annual climber; a very rapid grower and free bloomer; the vines branch freely, covering a large space very quickly and growing to a height of 20 to 30 feet. Succeeds best in a warm, sunny location and good soil. Leaves dark green and deeply lacinated; bears a great profusion of fiery, cardinal red flowers, which are about 1½ inches in diameter. In order to have good germination of the seed of Cardinal Climber, a small notch should be filed or cut in each seed. Per pkt. 15c.; 75c. per large pkt.



CELOSIA CRISTATA (Crested Cockscomb)

Very desirable annuals of easy culture, producing large, brilliant, comb-like heads; make excellent border plants, and are also attractive for pots; 1 to 1½ feet.

	Large pkt.	Pkt.
Giant Empress. Giant heads of rich crimson	\$0.40	\$0.10
Glasgow Prize. Showy dark crimson	.40	.10
Choice Mixed. Dwarf varieties	.oz., \$1.50	.30

CELOSIA PLUMOSA (Feathered Cockscomb)

A splendid decorative plant for the garden. The feathery plumes are produced on long stems and are excellent for cutting. Can also be cut and dried for winter bouquets.

	Large pkt.	Pkt.
Childsi (<i>Chinese Woolflower</i>). Plants grow 2½ feet high, and produce a large number of ball-shaped scarlet flowers, resembling silky wool. For illustration see page 53.	\$0.60	\$0.15
Childsi, Pink. Same type as above; flowers delicate pink	.75	.25
Golden Plume. Bright golden yellow plumes	.25	.10
Pride of Castle Gould. Plants grow compact and pyramidal, about 2 to 3 feet high, producing immense flower heads that closely resemble ostrich plumes. Colors are blood-red, carmine, yellow, orange, golden, orange-scarlet, etc., in mixture	.75	.15
Scarlet	.25	.10
Spicata. Of pyramidal growth; flowers pink, shading to silvery white; 3 feet	.25	.10
Thompsoni Magnifica. An improved strain with various colors, ranging from the clearest yellow to the darkest blood red; 3 feet	.30	.10
Thompson's Superb (<i>Triomphe de l'Exposition</i>). A strain with bronze colored foliage and graceful feathery plumes of brilliant crimson; 3 feet	.25	.10
Choicest Mixed. All colors	.oz., 60c.	.25



CENTAUREAS CENTAUREA CYANUS

(Cornflower or Bachelor's Button)

Also known as Blue Bottle, Ragged Sailor, Bluet, etc.; an old favorite garden annual; excellent for cutting; 2 feet.

	Oz.	Large pkt.	Pkt.
Double Blue. Large flowering.....	\$0.75	\$0.25	\$0.10
Double Rose.....	.75	.25	.10
Emperor William. Deep blue.....	.40	.25	.10
Pink.....	.40	.25	.10
White.....	.40	.25	.10
Choice Mixed.....	.40	.25	.05
Double Mixed.....	.50	.25	.05

CENTAUREA IMPERIALIS

(Giant Cornflower, or Sweet Sultan)

The finest of all Sweet Sultans for cut flower purposes; gigantic, beautiful, sweet-scented flowers borne on long stems. They are well adapted for cutting and remain fresh long after being cut. Height, 2 to 3 feet.

	Oz.	Large pkt.	Pkt.
Deep Rose.....	\$1.00	\$0.30	\$0.10
Lavender.....	1.00	.30	.10
Lilac.....	1.00	.30	.10
Brilliant Pink.....	1.00	.30	.10
Purple.....	1.00	.30	.10
White.....	1.00	.30	.10
Choice Mixed.....	.75	.25	.10
Collection. One packet each above 6 colors..			.50

NEW GIANT FLOWERED CENTAUREA

Magnificent flowers produced on long, stout stems; excellent for cutting.

	Large pkt.	Pkt.
Bride. Pure white.....	\$0.50	\$0.10
Bridegroom. Purplish mauve.....	.50	.10
Honeymoon. Golden yellow.....	.50	.10

WHITE LEAVED CENTAUREA (Dusty Miller)

Grown for their silvery foliage as edging plants, also for vases, hanging baskets, etc.

	500 Seeds.	Pkt.
Candidissima. Broad cut leaves of silvery gray...	\$0.30	\$0.10
Gymnocarpa. Fine cut silvery gray foliage.....	.20	.10

VARIOUS CENTAUREAS

	Large pkt.	Pkt.
Suaevolens (Yellow Sweet Sultan). Showy, bright yellow, fragrant blossoms.....	\$0.25	\$0.10
Montana. Blue; perennial; 18 inches.....	.40	.10

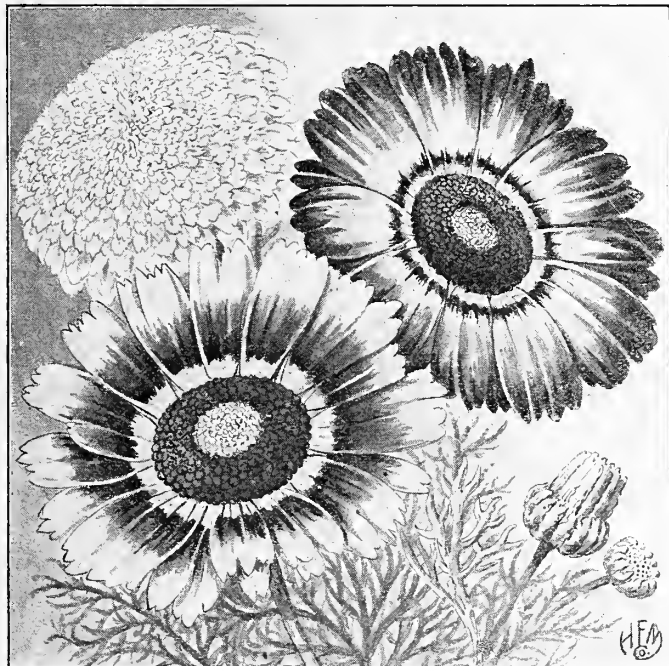

Annual Chrysanthemums



CERASTIUM (Snow in Summer)

	Large pkt.	Pkt.
Tomentosum. Dwarf, white-leaved edging plant; flowers white; 4 inches.....	\$0.50	\$0.15

CHINESE WOOLFLOWER (See Celosia)

CHRYSANTHEMUM (Annual Varieties)

Exquisitely colored daisy-like flowers with finely cut foliage; good for cutting; also effective as a border plant.

	Large pkt.	Pkt.
Helios (Evening Star). Extra large pure golden yellow flowers often measuring 4 inches across; height, 2 feet.....	\$0.25	\$0.10
Double Mixed.....	oz., 40c. .25	.05
Single Mixed.....	oz., 40c. .25	.05

CHRYSANTHEMUM (Perennial Varieties)

Japanese Hybrids. Large flowers of the finest types; an extra choice mixture; seed sown in spring will produce flowering plants by fall; 2 feet.....	.75	.15
King Edward VII. Flowers extra large; pure white; very free flowering.....	.30	.10
Shasta Daisy, "Alaska." Extra large flowers, of pure glistening white, with broad overlapping petals; a beautiful cut flower; 2 feet.....	.60	.20
Early Flowering Double and Semi Double Mixed. A new perennial variety, which can also be treated as an annual, blooming the first year from seed. The flowers are of many colors and shades. For full description, see page 53.....	.85	.35

See pages 52 to 56 for Novelties in Flower Seeds.

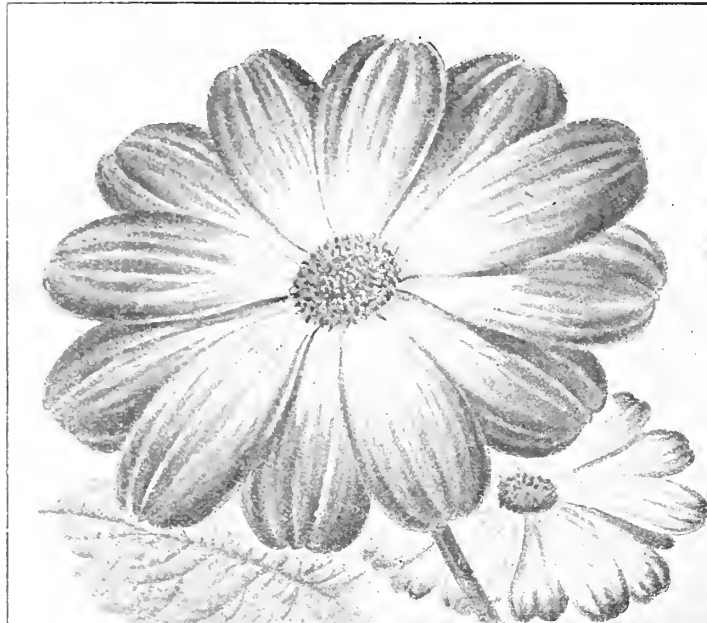

Cineraria, Michell's Grandiflora Prize (large pkt. 85c.)

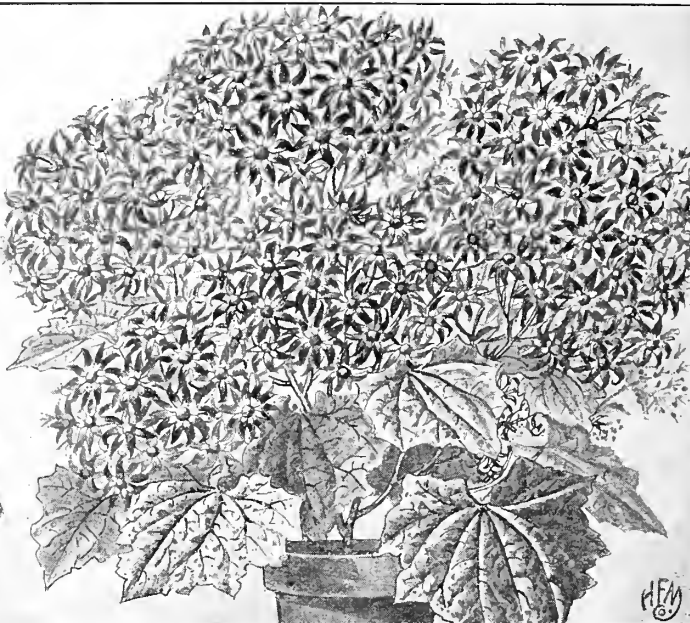

Cineraria, Stellata Hybrida (large pkt. 85c.)

CINERARIA

Most ornamental plants for conservatory or house decoration; seed may be sown from May to September for a succession. Our Grandiflora Prize Strain cannot be surpassed; immense trusses of large flowers, often measuring 4 inches across.

- Grandiflora Prize Dwarf.** Mixed colors; plants of dwarf habit. Large pkt. Pkt. \$0.85 \$0.35
- Grandiflora Prize Medium Tall.** Mixed colors; desirable as a decorative plant. .85 .35
- Matador.** Large flowering scarlet. .85 .35
- Stellata Hybrida.** Of graceful habit; producing a profusion of flowers; mixed colors. .85 .25

WHITE-LEAVED CINERARIA (Dusty Miller)

- Maritima Candidissima.** Silvery green, Large pkt. Pkt. lacinated foliage; good for edging. .25 .05

CLARKIA

Annuals of easy culture; planted in large groups they are very bright and effective.

- Queen Mary.** Double; rose carmine. Large pkt. Pkt. \$0.25 \$0.10
- Salmon Queen.** Salmon pink; double. .25 .10
- Scarlet Queen.** Double; orange scarlet. .25 .10
- White.** Double. .25 .10
- Single Mixed.** All colors. .25 .05
- Double Mixed.** All colors. .25 .05

CLEMATIS

Perennial climbers; fine for arbors, verandas, etc. Large pkt. Pkt.

- Flammula.** Feathery white, fragrant flowers. \$0.25 \$0.10
- Paniculata (Japanese Virgin's Bower).** The beautiful autumn-flowering variety, admired for its fragrant, white, star-shaped flowers. .25 .10

CLEOME (Spider Plant)

An attractive annual plant with curious heads of flowers.

- Pungens.** Pink flowers. Large pkt., \$0.25; Pkt., \$0.10

COBAEA SCANDENS (Cup and Saucer Vine)

Well-known climber of rapid growth, producing large, bell-shaped blossoms; in sowing, place the seeds edgewise, and merely cover with light soil.

- Purple.** Large pkt. Pkt. oz., 60c. \$0.25 \$0.10
- White.** .30 .10

COCKSCOMB (See Celosia)

COIX LACHRYMAE (Ornamental Grass)

(See page 64)

COLEUS

Large pkt. Pkt.

- Large Leaved Hybrids.** Popular bedding plants, with beautifully colored foliage; easily grown from seed if kept in a warm temperature. \$0.75 \$0.25

COLUMBINE (See Aquilegia)
CONVOLVULUS (Morning Glory)
MAJOR, OR TALL VARIETIES

One of the most popular annual climbers, growing about 15 feet in height and thriving in almost any situation. Oz. Pkt.

- Japanese Imperial.** Flowers of immense size and of a great variety of colors. \$0.25 \$0.05
- Japanese Imperial Fringed.** Large fringed flowers of many beautiful colors and shades. .40 .10
- Snow Fairy.** A new and beautiful variety producing an abundance of large double, snow-white, tassel-like flowers. .75 .10
- Mixed.** The ordinary variety. .20 .05
- Double Flowering.** Mixed colors. 1.00 .10

MINOR, OR DWARF VARIETIES

A very showy, hardy annual for flower beds and borders; also rock work; height, 1 foot. Oz. Pkt.

- Tricolor.** Blue. \$0.25 \$0.10
- Mixed Colors.** .20 .05

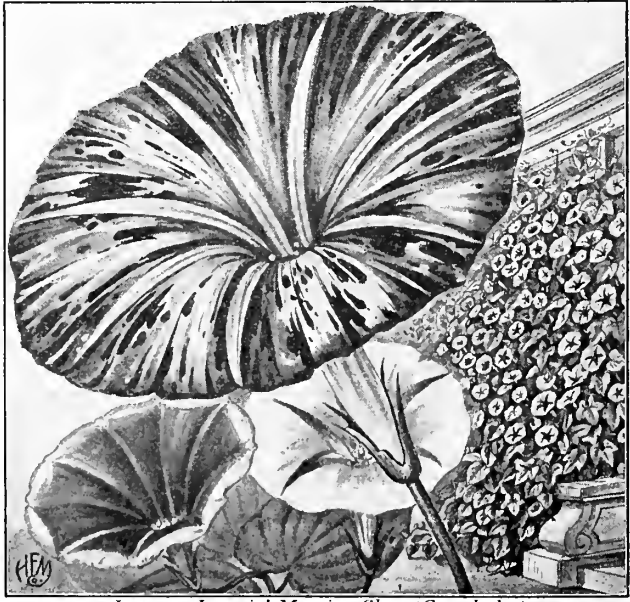

Japanese Imperial Morning Glory (Convolvulus)

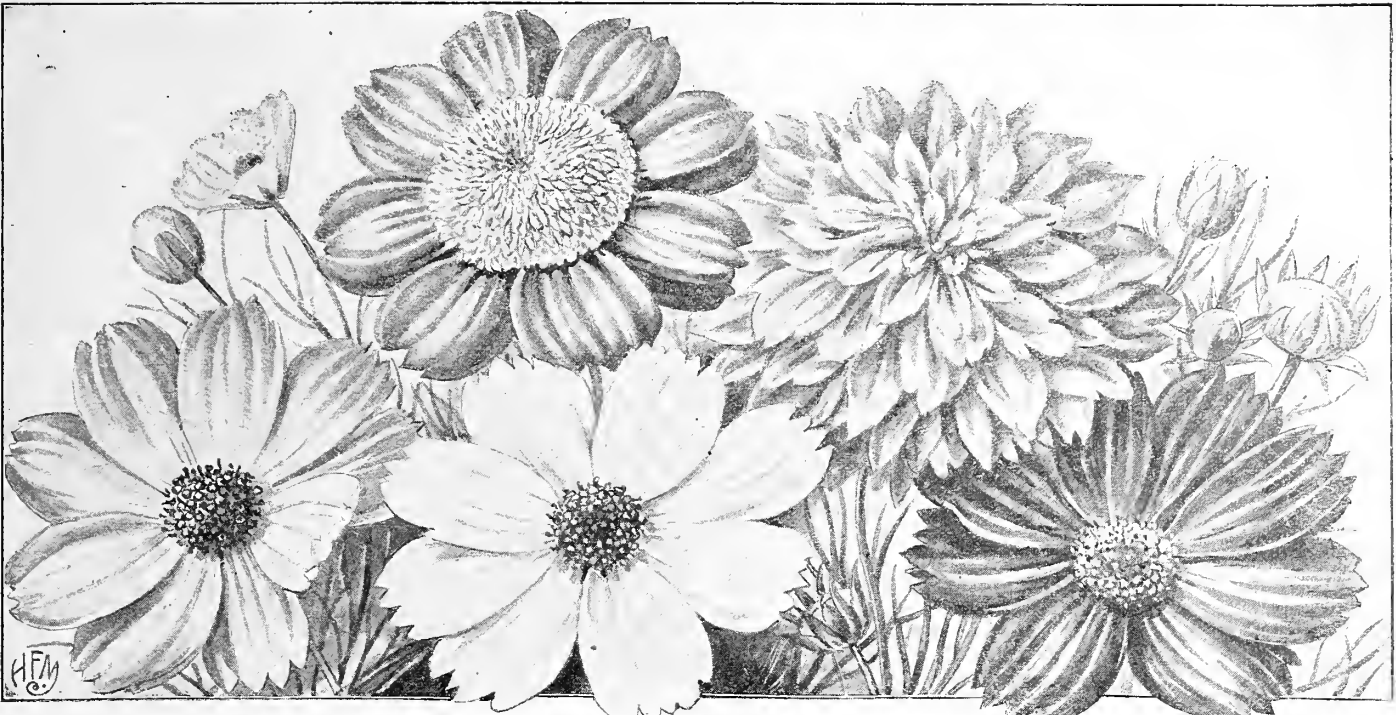

Michell's Giant Flowering Cosmos

COSMOS

One of the most beautiful and useful of hardy annuals, producing large showy flowers in great profusion; excellent for cutting. Any garden soil will grow Cosmos to perfection.

DOUBLE EARLY FLOWERING COSMOS

This new early flowering strain will begin blooming in July and continue until frost. The flowers are full, round and double.

	Large pkt.	Pkt.
Double Early Flowering, Crimson	\$0.85	\$0.25
“ “ “ Pink85	.25
“ “ “ White85	.25
“ “ “ Mixed75	.25

DOUBLE LATE FLOWERING COSMOS

	Large pkt.	Pkt.
Double Eureka Pink. The flowers are full, round, double and very fine.	\$0.75	\$0.25
Double Snowball. White75	.25
Double Crested Pink Beauty. A large percentage of the flowers have double crowns, giving them an attractive appearance.60	.15
Double Crested White Queen. Pure white60	.15
Double Crested Mixed60	.15

GIANT LATE FLOWERING COSMOS

Large flowers of perfect form, on long stems and lasting until frost; 5 to 6 feet.

	Oz.	Large Pkt.	Pkt.
Giant Crimson	\$0.50	\$0.25	\$0.10
“ Pink50	.25	.10
“ White50	.25	.10
“ Mixed40	.25	.05
“ Fancy Varieties. Mixed colors.90	.30	.10
“ Crimson Ray. Large flowers with narrow, fluted crimson petals, separated in star-like form.60	.25	.10
Giant Lady Lenox. Flowers are of immense size, with wide overlapping petals, making a perfectly circular flower; shell pink.50	.25	.10
Giant White Lady. A selection from the Lady Lenox described above; pure white.50	.25	.10
Klondyke. Large golden yellow flowers.	1.50	.30	.10

COSMOS—Continued

LARGE EARLY FLOWERING COSMOS

This new Early Flowering Strain will begin blooming as early as July and will continue until frost; flowers large, often measuring 3 inches across; 4 feet.

	Oz.	Large Pkt.	Pkt.
Crimson	\$0.75	\$0.25	\$0.10
Pink75	.25	.10
White75	.25	.10
Mixed60	.25	.10

COWSLIP (See Primula Veris)

CUPHEA (Cigar Plant)

Platycentra. Interesting bedding plant; the flower is shaped like a hollow cigar; color, scarlet with a black and white tip; 1 foot.

	Large Pkt.	Pkt.
.....	\$0.60	\$0.10

CYCLAMEN

Most beautiful winter and spring flowering plants for the window and greenhouse. Not only are the flowers of striking beauty, but the foliage is also highly ornamental.

MICHELL'S GIANT SHOW

Grown for us by a specialist who has received numerous first prizes for the large size and beautiful coloring of the flowers.

	100 Seeds	Pkt.
Bright Red	\$2.50	\$0.50
Dark Blood Red	2.50	.50
Glory of Wandsbek. Salmon red	2.50	.50
Perle of Zehlendorf. Salmon pink	2.50	.50
Pure White	2.50	.50
Rose of Marienthal. Bright pink	2.50	.50
White with Carmine Eye	2.50	.50
Mixed. All colors	2.00	.40

CYPERUS (Umbrella Plant)

Alternifolius. An elegant plant for growing in water or damp places; useful as a pot plant.

	Large pkt.	Pkt.
.....	\$0.50	\$0.10

CYPRESS VINE (Ipomoea Quamoclit)

A very graceful twining annual climber, with very delicate fern-like foliage; it is of rapid growth, and a beautiful vine for trellises, verandas, etc. Seed should be soaked for a few hours in warm water before sowing; 15 feet.

	Oz.	Large Pkt.	Pkt.
Scarlet	\$0.50	\$0.25	\$0.10
White50	.25	.10
Mixed40	.25	.05

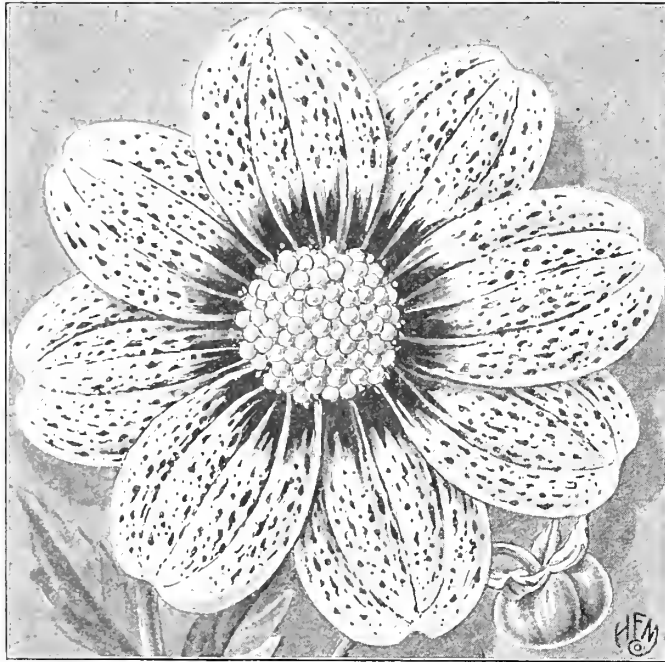

Dahlia, Giant Perfection. (Large pkt. 30c.)

DAHLIAS (From Seed)

There is no more fascinating flower to raise from seed than the Dahlia, for the result is a series of surprises. Seed should be started in the house from February till May, and the young plants should not be set outdoors until danger from frost is past.

DOUBLE FLOWERING VARIETIES

	Large pkt.	Pkt.
Cactus. Choice mixed, from the best varieties.	\$0.60	\$0.10
Large Flowering (<i>Show Type</i>). Mixed; extra fine50	.10

SINGLE FLOWERING VARIETIES

Collarette. Flowers of various colors, with a collar of small petals around the centre; novel and beautiful40	.15
Giant Perfection. Immense single flowers of various colors; many beautifully striped and spotted30	.10

DAISY, ENGLISH DOUBLE (Bellis Perenns)

These are favorite perennials; seed should be sown from June 1st till September, transplanted in the fall and protected during the winter, and they will flower the following spring. If sown in the spring they will flower in the autumn; 4 inches. Large pkt. Pkt.

Longfellow. Large double pink flowers.	\$0.60	\$0.10
Monstrosa, Pink. These surpass all strains of this popular plant in strong, robust growth and in the abundance of extra large, perfectly double flowers75	.25
Monstrosa, White75	.25
Monstrosa, Mixed75	.25
Snowball. Purest white; large and double60	.10
Double Mixed. Extra fine50	.10

DATURA (Trumpet Flower)

A most ornamental plant, growing quite bushy, with extra large trumpet-shaped flowers; height, 2 to 3 feet. Large pkt. Pkt.

Cornucopia (<i>Horn of Plenty</i>). Large double sweet-scented flowers; white marbled with purple	\$0.25	\$0.10
Double Mixed. Various colors25	.05



Delphinium, Belladonna. (Large pkt. 75c.)

DELPHINIUM (Hardy Perennial Larkspur)

One of the finest hardy perennials; very easily grown from seed, blooming the first season if sown early. Very effective in beds, masses or borders. To prolong the season of bloom, cut the old flower stems off after they have faded, and new shoots will produce flower heads successfully. Large pkt. Pkt.

Belladonna. One of the most continuous blooming varieties; immense spikes of clear turquoise blue, which cannot be excelled for beauty; 5 feet.	\$0.75	\$0.25
Bellamosum. A rich, deep blue form of the popular light blue Belladonna75	.25
Chinense Grandiflorum. A dwarf strain with loose branches and sprays of bright blue flowers; 2 feet. oz., 90c.	.30	.10
Chinense Grandiflorum Album. Pure white flowers oz., 90c.	.30	.10
Elatum (Bee Larkspur). Rich blue; 4 feet. oz., \$1.50	.40	.10
Formosum. Deep blue; 3 feet. oz., 2.25	.40	.10
Formosum Coelestinum. Sky blue.60	.15
Gold Medal Hybrids. Produces long spikes of large flowers, the lighter shades of blue predominating.60	.15
Kelway's Giant. An extra fine strain of strong, vigorous growth, with immense spikes of large flowers; many shades of blue; 5 to 7 feet60	.15
Rev. E. Lascelles. An extra fine variety; large double deep blue flowers with white centre75	.15
Zalil. Sulphur yellow; 4 feet.60	.10
Hybridum Mixed. Very choice; 4 feet. oz., 75c.	.25	.05

For Annual Larkspur, see page 76.

DIDISCUS

Coeruleus (Blue Lace Flower). An annual, blooming from July until frost; color, pale lavender; excellent for cutting; see page 53 for illustration.60	.25
--	-----	-----



Dianthus—Annual Pinks

DIANTHUS (Pinks)

A most satisfactory class of flowers, easily raised from seed; are in constant bloom the entire season; excellent for cutting.

DOUBLE ANNUAL SORTS	Large pkt.	Pkt.
China or Indian Pink. All colors mixed	oz., 60c.	\$0.25 \$0.05
Fireball. Fiery scarlet	oz., \$1.50	.30 .10
Fringed. Large flowers; mixed	oz., \$1.00	.30 .10
Japan Pink. Choice mixed	oz., 75c.	.25 .10
White. Large fringed flowers	oz., \$1.50	.30 .10

SINGLE ANNUAL SORTS

Japan Pink. All colors. Mixed	oz., 75c.	.25 .05
Nobilis (Royal Pinks). An improved strain; a varied range of bright colorings	oz., \$1.25	.30 .10
Salmon Queen. Fringed; salmon pink	oz., \$1.25	.30 .10
Vesuvius. Brilliant geranium red	oz., \$1.25	.30 .10
Imported Collection. 6 varieties		.40

HARDY GARDEN PINKS

Elegant summer flowering border plants, producing a wealth of deliciously fragrant flowers.

Clove Scented. Double and semi-double varieties, in beautiful colors; fragrant		\$0.50 \$0.10
Double Scotch. Choice colors		.50 .15
Erfurt. Dwarf; compact; early; mixed colors		.60 .10
Latifolius Atrococcineus Fl. Pl. (Everblooming Hybrid Sweet William). Free flowering; velvety crimson scarlet; double		.40 .10
Pheasant's Eye. Single fringed flowers; mixed colors	oz., 75c.	.25 .10

DICTAMNUS (Gas Plant)

Fraxinella. Showy, bushy plants; 2½ feet high; purple red flowers; June and July		.25 .10
---	--	---------

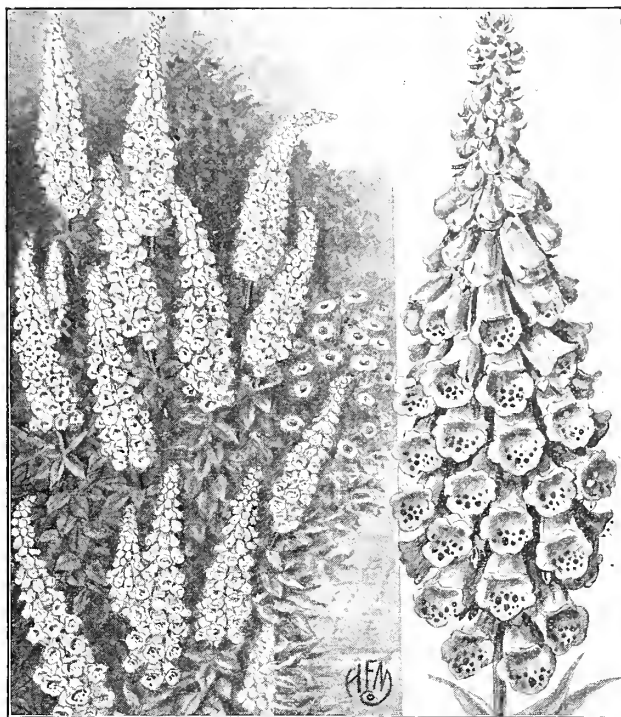

Digitalis (Foxglove) Gloxiniaeflora

DIGITALIS (Foxglove)

Handsome ornamental hardy plants of stately growth, succeeding almost anywhere. Produces long spikes of beautiful, tubular-shaped flowers; 4 to 5 feet.

	Oz.	Large Pkt.	Pkt.
Gloxiniaeflora, Pink	\$1.00	\$0.30	\$0.10
“ Purple	1.00	.30	.10
“ White	1.00	.30	.10
“ Mixed	.75	.25	.05
Grandiflora, Yellow	.90	.25	.10
Monstrosa (Mammoth Foxglove). The tall spikes are surmounted by one monstrous flower. All colors mixed	1.25	.30	.10



Dimorphotheca Aurantiaca

DIMORPHOTHECA Large pkt. Pkt.

Aurantiaca (African Orange Daisy). One of the showiest garden annuals; compact, bushy plants with orange-gold daisy-like blooms on long stems; excellent for cutting	\$0.30	\$0.10
Aurantiaca Hybrida. A splendid mixture of colors and shades, from white through various shades of yellow, orange, rose, etc.	.30	.10

MICHELL'S EVERLASTING FLOWERS

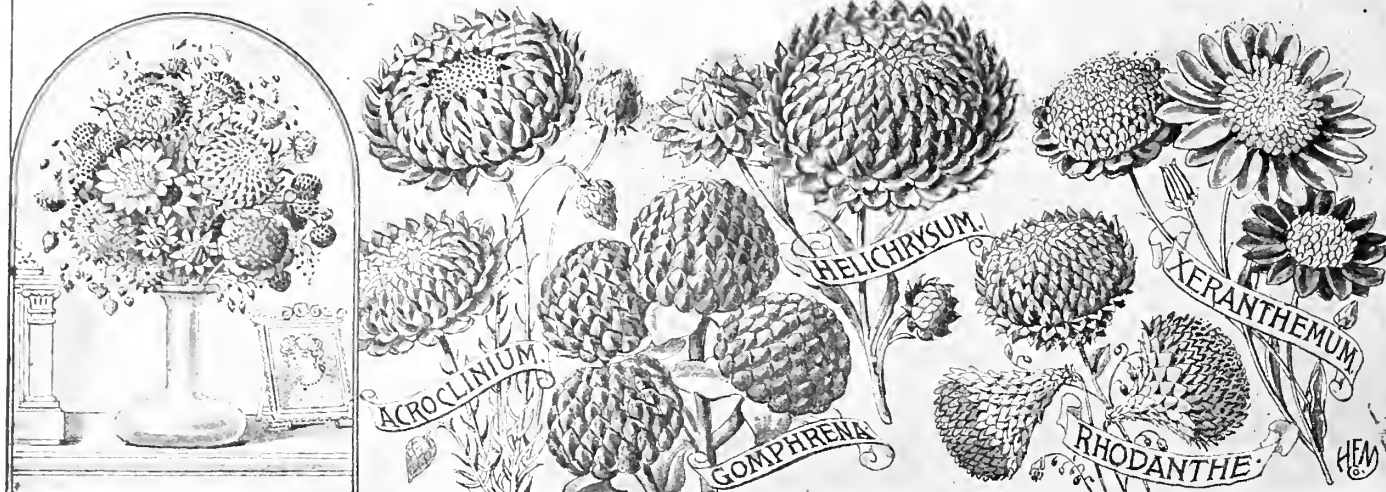

Everlastings should be grown in every garden, not only for summer blooming, but also as cut flowers for winter decoration. The flowers should be picked before they expand and hung, with the tops downward, to dry for winter bouquets.

ACROCLINIUM (Everlasting Flower)

Showy, free-flowering annual plants; excellent for cutting.
1 foot. Large pkt. Pkt.
Double Rose Pink \$0.30 \$0.10
Double White30 .10
Double Mixed25 .05

GOMPHRENA (Globe Amaranth)

Also called "Bachelor's Buttons;" a showy annual everlasting; flowers resemble clover heads and when dried are useful for winter bouquets; fine for bedding.

	Oz.	Large Pkt.	Pkt.
Nana Compacta. Dwarf red; 1 foot.....	\$0.75	\$0.25	\$0.10
Mixed. All colors; 2 feet.....	.50	.25	.05

RHODANTHE (Everlasting Flower)

A beautiful annual, for the garden or for pot culture; valuable for dried winter bouquets; 1 foot. Large pkt. Pkt.

Double Pink. Fine for cutting.....	\$0.40	\$0.10
Mixed Colors.....	.25	.05

HELICHRYSUM (Strawflower)

One of the best and most popular of the everlasting flowers; the varieties offered below are all of the Monstrosum type, producing larger and more perfectly double flowers than the old variety. Valuable for cutting or decoration, either when fresh or in their dried state. 2 feet. Oz. Large pkt. Pkt.

Fireball. Crimson.....	\$0.90	\$0.30	\$0.10
Golden Ball. Golden yellow.....	.90	.30	.10
Rose Carmine.....	.90	.30	.10
Salmon Pink.....	.90	.30	.10
Silver Ball. White.....	.90	.30	.10
Violet.....	.90	.30	.10
Choice Mixed.....	.75	.25	.05

Collection, one packet each of above six colors, 50c.

XERANTHEMUM (Everlasting Flower)

Double Mixed. Showing hardy annual of easy culture producing a profusion of flowers; excellent for winter bouquets. Large pkt. Pkt. \$0.25 \$0.10

DOLICHOS (Hyalnth Bean)

Rapid growing annual climber, bearing a profusion of bean-like flowers; excellent for arbors, trellises, etc. Oz. Pkt.

Darkness. A variety from Japan; rapid grower; flowers reddish violet.....	\$0.25	\$0.10
Daylight. Identical to the above except in color which is pure white.....	.25	.10
Choice Mixed.....	.20	.05

DRACAENA

Ornamental plants for vases or conservatory decoration.

Australis. Broad green leaves.....	Large pkt. Pkt.
Indivisa. Narrow green leaves.....	oz., 50c. .25 .10

ECHINOCYSTIS (Wild Cucumber Vine)

Lobata. One of the quickest growing vines; excellent for covering trellises, fences, etc. oz., 35c. .25 .05

ESCHSCHOLTZIA (California Poppy)

An elegant hardy annual with fine cut foliage, and large, Poppy-like flowers; in bloom from June until frost; fine for borders or large beds; 1 foot. Large pkt. Pkt.

Californica. Pure yellow.....	oz., 40c.	\$0.25	\$0.05
Carmine King. Beautiful carmine rose.....	oz., 60c.	.25	.10
Golden West. Large golden yellow flowers.....	oz., 40c.	.25	.10
Mandarin. Inner side of petals orange, outer petals brilliant scarlet.....	oz., 50c.	.25	.10
Mauve Beauty (New). Beautiful lavender mauve. Flowers large and attractive.....	.60	.25	
Rose Cardinal. Carmine rose.....	oz., 40c.	.25	.10
Vesuvius. Rich wallflower or coppery red.....	oz., 75c.	.25	.10
White.....	oz., 40c.	.25	.10
Choice Mixed.....	oz., 35c.	.25	.05
Collection, one packet each, 8 varieties.....			.60

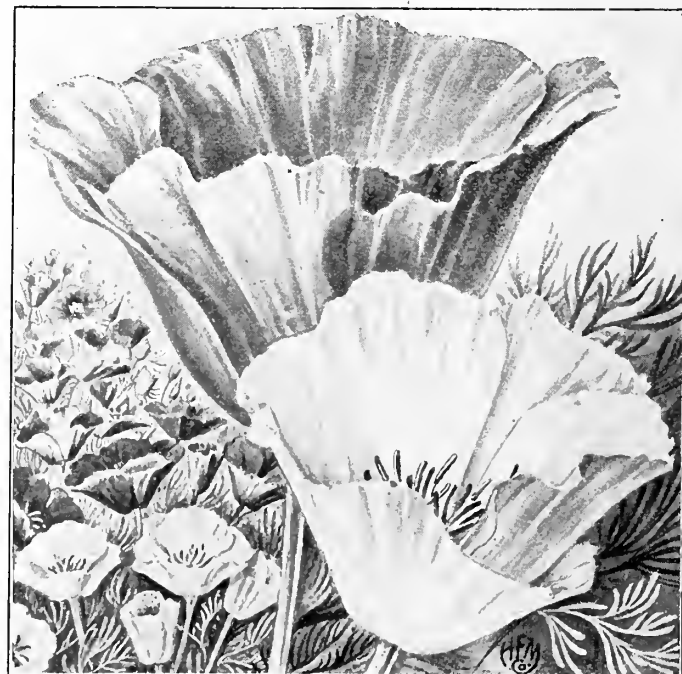

Eschscholtzia (California Poppy)

EULALIA (Ornamental Grass). See page 74.

EUPATORIUM

A fine hardy perennial, which will grow and thrive in almost any situation; blooms the first season from seed if sown early; excellent for cutting; 2 feet. Large pkt. Pkt. **Fraseri.** Feathery white flowers\$0.25 \$0.10

EUPHORBIA

Plants with ornamental foliage; very showy and easily raised from seed; height, 2 feet. Large pkt. Pkt.

Heterophylla (Mexican Fire Plant). Glossy green leaves, turning to orange scarlet in mid-season... \$0.30 \$0.10

Variegata (Snow on the Mountain). Foliage veined and margined with white.....oz., 60c. .25 .10

FERNS

Adiantum (Maiden Hair). Mixed..... 1.00 .15

Pteris Varieties. Mixed..... 1.00 .15

All Sorts Mixed. Choice collection 1.00 .15

We can also furnish all other good varieties of fern spores.

FEVERFEW (Matricaria)

Double White. Hardy annual; free flowering; for bedding or pot culture; showy double white flowers; 18 inches.....oz., 60c. .25 .10

FORGET-ME-NOT. (See Myosotis)

FOUR O'CLOCK. (See Marvel of Peru)

FOXGLOVE. (See Digitalis)

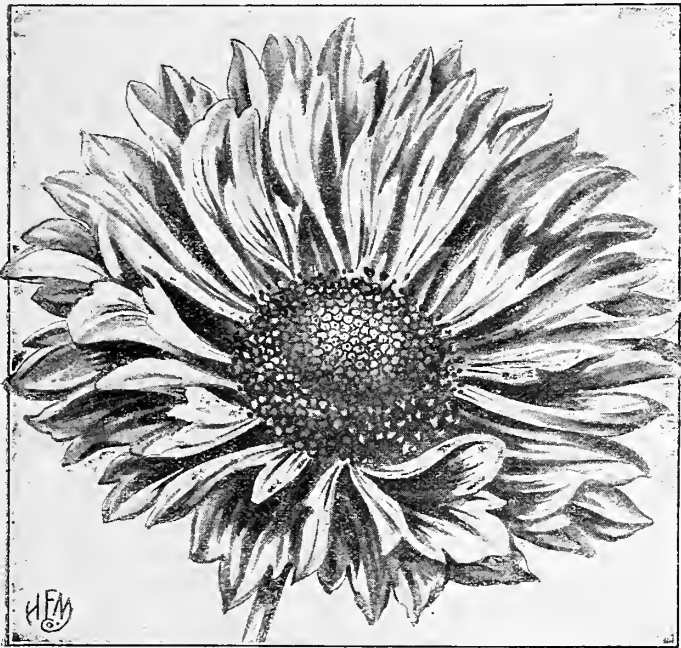

Gaillardia, Grandiflora Superba

GAILLARDIA (Blanket Flower)

ANNUAL VARIETIES

A splendid garden flower and excellent for cutting. The large highly colored, daisy-like flowers appear uninterruptedly the entire season on stout erect stems often 15 to 18 inches in length.

Large pkt. Pkt. **Picta Lorenziana.** Double mixed.....oz., 60c. \$0.25 \$0.10

Picta Mixed. Single flowers in all colors..oz., 50c. .25 .05

PERENNIAL VARIETIES

One of the most brilliant of hardy perennials; blooming the first year from seed if sown early; 2 feet. Large pkt. Pkt.

Grandiflora Compacta. A compact variety; choice mixed colors; 12 to 15 inches.....oz., 90c. \$0.25 \$0.10

Grandiflora Sanguinea. Blood red flowers..... .30 .15

Grandiflora Semi-Double. Mixed..... .30 .10

Grandiflora Superba. Mixed colors....oz., \$1.50 .25 .10

GENTIANA (Blue Gentian)

Large pkt. Pkt. **Acaulis.** A dwarf hardy perennial; deep blue flowers; suited to moist, shady situations.....\$0.40 \$0.10

GERANIUM

100 Seeds Pkt. **Apple Scented.** Highly esteemed on account of its fern-like, fragrant foliage; 1 foot..... \$0.40 \$0.10

Pelargonium (Lady Washington). Seed saved from the largest flowered show varieties..... 2.50 .25

Large pkt. Pkt. **Zonale Mixed.** A superb strain of the largest and finest varieties; 1 to 2 feet.....\$0.60 \$0.10

GERBERA (Transvaal Daisy)

Splendid greenhouse perennials with large fine-leaved, daisy-like flowers; splendid for pot plants or cutting. 100 Seeds Pkt.

Jamesoni Gigantea. Large flowers of bright scarlet. \$1.25 \$0.25

Jamesoni Hybrida. These hybrids include a wonderful range of brilliant colors and shades..... 1.00 .25

GEUM

Large pkt. Pkt. **Atrosanguineum Fl. Pl.** A beautiful hardy perennial, bearing large, showy, double, dark crimson flowers all through the summer; fine for bouquets; 1 1/2 ft.....\$0.30 \$0.10

Mrs. Bradshaw. Large, double brilliant scarlet flowers; blooms the entire summer 60 .15

GLOXINIA

Hybrida Grandiflora. An extra fine strain, embracing all the choicest self-colored and tigered and spotted flowers \$5 .25

GODETIA (Satin Flower)

Beautiful and easily grown hardy annuals, producing a profusion of flowers of satiny texture. Large pkt. Pkt.

Duchess of Albany. Pure white, of compact growth. \$0.25 \$0.10

Gloriosa. Large, blood-red flowers..... .25 .10

Rosamond. Of dwarf habit; flowers shell-pink.... .25 .10

Choice Mixed. All colors..... .25 .05

GOMPHRENA (Globe Amaranth)

See Everlastings, page 72.

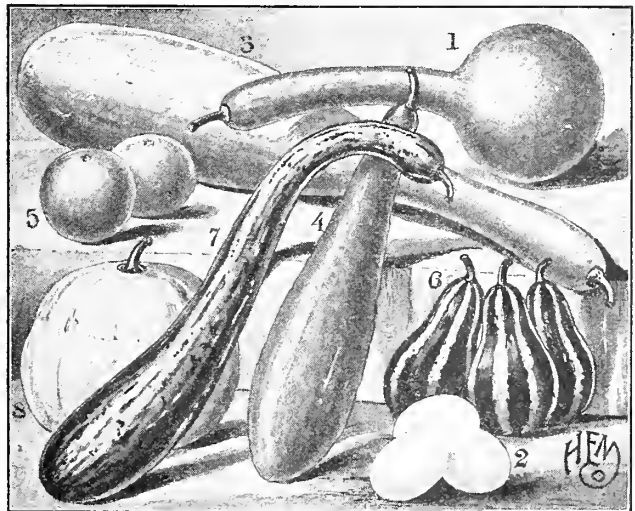

Ornamental Gourds

GOURD (Ornamental)

Large Pkt. Pkt. **Calabash or Dipper.** No. 1.....Oz. \$0.40 \$0.25 \$0.05

Egg-Shaped. White like an egg. No. 2... .40 .25 .05

Hercules Club. Club-shaped. No. 3.... .40 .25 .05

Luffa (Dish Rag or Bonnet Gourd). No. 4... .40 .25 .05

Orange-Shaped (Mock Orange). No. 5..... .40 .25 .05

Pear-Shaped. Striped. No. 6..... .40 .25 .05

Sugar Trough. Used as water holder. No. 8. .40 .25 .05

Mixed. In a great variety40 .25 .05

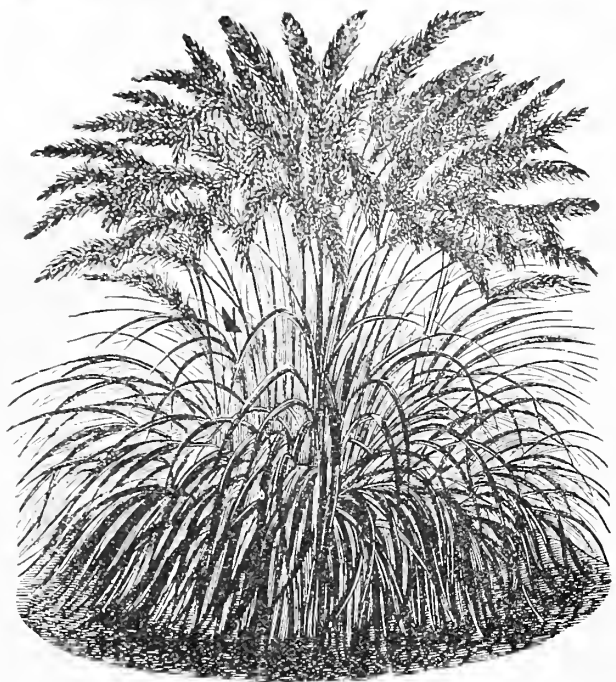

Pennisetum, Ruppelianum (Ornamental Grass)

GRASSES (Ornamental)

These are very interesting and useful, either for growing in clumps, mixed borders or in shrubberies. Also when dried they are fine for winter bouquets and decorations, for which purpose they should be gathered before fully matured.

ARUNDO (Great Reed)

Donax. Perennial with drooping green and white striped leaves; excellent for lawn clumps; 9 feet... Large pkt. Pkt. \$0.25 \$0.10

AVENA (Animated Oats)

Sterilis. Long, sensitive awns which expand and contract, causing the seed to rattle in the pod; annual; 18 inches... .25 .10

BRIZA (Quaking Grass)

Maxima. Elegant panicles; excellent for bouquets and dried flowers; annual; 1 foot... .25 .10

BROMUS

Brizaeformis. Large drooping panicles, useful for bouquets; 2 feet; annual... .25 .10

COIX LACHRYMAE (Job's Tears)

A strong, broad leaved ornamental grass, with large shining, pearly seeds; annual; 2 to 3 feet...oz., 20c. .05

EULALIA

Japonica. A hardy perennial variety, with long graceful leaves; green and white striped; 4 to 5 feet .25 .10

GYNERIUM (Pampas Grass)

Argenteum. White silvery plumes; perennial; blooms the second season; 8 to 10 feet... .25 .10

HORDEUM JUBATUM (Squirrel Tail Grass)

Bushy panicles; excellent for bouquets; annual; 3 feet .25 .10

PENNISETUM

Longistylum. Graceful greenish-white plumes, fine for beds or dried bouquets; 2 feet; annual... .25 .10

Ruppelianum (Purple Fountain Grass). Excellent for beds or for dried bouquets; purple plumes; 3 feet; annual... .25 .10

STIPA PENNATA (Feather Grass)

Hardy perennial with silvery-white, feathery plumes; flowers the second season; 2 feet... .40 .10

One packet each of the above 11 varieties of Ornamental Grasses for 75 cents.

GREVILLEA (Silk Oak)

Robusta. A beautiful and graceful decorative plant with fern-like foliage; excellent for table decoration; easily raised from seed. Produces good sized plants in a short time. Pkt., 10c.; 30c. per large pkt.; oz., 90c.

GYPSOPHILA Baby's Breath

Pretty, free-flowering plants of easy culture; excellent for cutting to mix with other flowers; 2 feet.

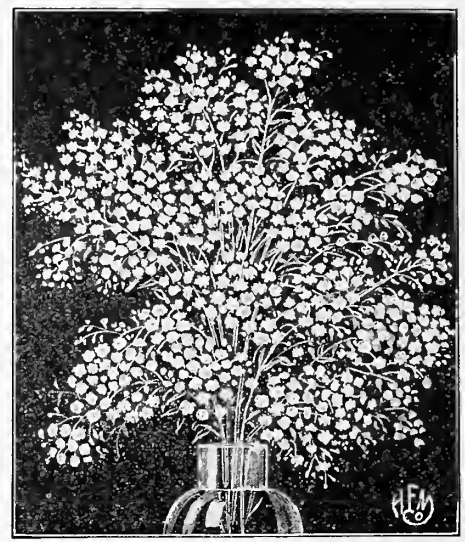

Gypsophila Paniculata Fl. Pl.

	Oz.	Large pkt.	Pkt.
Elegans Alba Grandiflora. A hardy annual variety; delicate sprays of pure white flowers.....		\$0.40	\$0.25 \$0.10
Elegans Carminea. Bright carmine rose... .40		.25	.10
Paniculata. Hardy perennial variety; flowers in graceful sprays of white; will bloom the first season if sown early.....	.60	.25	.10
Paniculata fl. pl. Perennial, with a profusion of double white flowers.....		.75	.20

HELENIUM (Sneeze-Wort)

Autumnale Superbum. Hardy perennial, succeeding in almost any kind of soil; large heads of golden yellow flowers; blooms in late summer and autumn, 5 to 6 feet... .40 .10

HELIANTHUS (See Sunflower)

HELICHRYSUM (Strawflower)

See Everlastings, page 72.

HELIOPSIS (Orange Sunflower)

Pitcheriana. A handsome hardy perennial, producing an abundance of deep orange-yellow flowers the entire summer; excellent for cutting; 3 to 4 feet... Large pkt. Pkt. \$0.25 \$0.10

HELIOTROPE

A well-known and highly prized plant on account of the delightful fragrance of the flowers; seed started indoors in the spring will make fine plants for summer blooming; can also be sown outdoors in May; excellent for pots, or for bedding; 18 inches.

Lemoine's Giant. Produces a profusion of flowers nearly double the size of the old sort; mixed colors... Large pkt. Pkt. \$0.50 \$0.15

Regal. Of dwarf compact growth; immense flowers; all shades... .60 .15

Choice Mixed. Of many varieties... .40 .10

HEUCHERA (Alum Root)

Sanguinea. Hardy perennial; spikes of vivid crimson flowers; excellent for cutting; 1 foot... .60 .10

HIBISCUS (Marsh mallow)

Showy ornamental perennial plants for mixed beds or shrubbery borders, with large and beautifully colored flowers.

Crimson Eye. Flowers large; color, pure white with velvety crimson centre, 4 feet... Large pkt. Pkt. \$0.30 \$0.10

Golden Bowl. Giant yellow, maroon centre... .30 .10

Moscheutos. Large, rosy pink flowers... .25 .10

New Giant (Mallow Marvel). A greatly improved form; gigantic single flowers; many shades of red, pink, purple and white in mixture... .25 .15

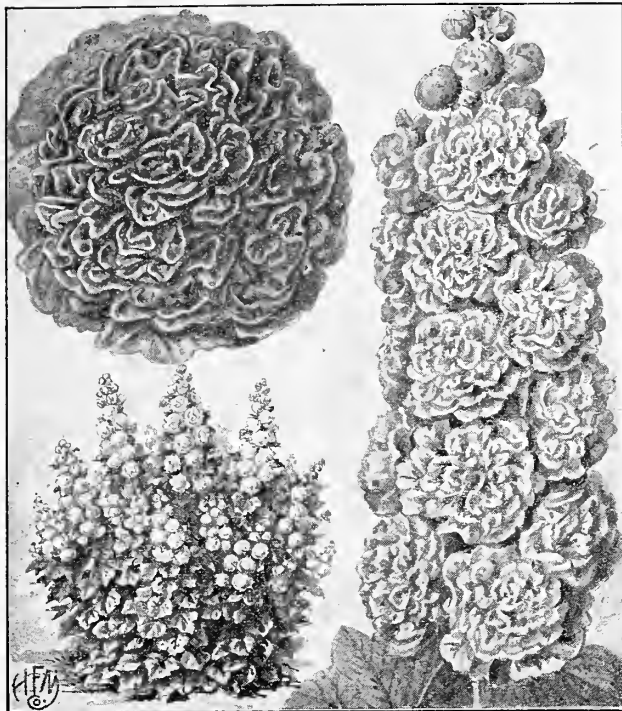

Hollyhock, Chater's Double

HOLLYHOCK

A popular and desirable hardy perennial plant, succeeding best in rich, well-drained soil, excellent for planting among shrubbery or forming a background for other flowers; seed sown any time before midsummer will produce fine plants for blooming the following summer; 6 to 7 feet.

	Oz.	Large Pkt.	Pkt.
Allegheny. Semi-double; mammoth flowers, edges fringed and lacinated; mixed.....	\$1.25	\$0.30	\$0.10
Chater's Double Maroon	1.50	.30	.10
Chater's Double Pink	1.50	.30	.10
Chater's Double Red	1.50	.30	.10
Chater's Double Salmon	1.50	.30	.10
Chater's Double White	1.50	.30	.10
Chater's Double Yellow	1.50	.30	.10
Chater's Double Mixed	1.25	.30	.10
Collection , one packet each of above 6 colors			.50
Single Mixed75	.25	.10

ANNUAL EVERBLOOMING HOLLYHOCK

While these are also hardy perennial varieties, if seed is sown in the house in March or April they will bloom the first season.

	Oz.	Large Pkt.	Pkt.
Double Ever-blooming Mixed. Colors range from white to deep black, yellow, pink, red and purple.....	\$1.50	\$0.40	\$0.15
Single Ever-blooming Mixed90	.30	.10

HONESTY (Lunaria)

	Large Pkt.	Pkt.
Biennis Alba. Hardy biennial, admired for its silvery seed pods, which are used for ornamental purposes; beautiful and curious, 2 feet.....	\$0.25	\$0.05

HORDEUM (Ornamental Grass) See page 74.

HUMULUS (Japanese Hop)

	Oz.	Large Pkt.	Pkt.
A rapid growing annual climber with luxuriant foliage; excellent for covering verandas, trellises, etc.			
Japonicus. The foliage resembles that of the Oz. common Hop; is very dense, and of a lively green color.....	\$0.50	\$0.25	\$0.10
Japonicus Variegatus. A variegated variety of the above. The leaves are beautifully mottled and splashed silvery white, light and dark green.....	.60	.25	.10

HUNNEMANNIA (Giant Yellow Tulip Poppy)

Fumariaefolia. Sown outdoors in May it produces large quantities of giant yellow tulip-like flowers during end of July, continuing for the balance of the season; the foliage resembles *Eschscholtzia*; height, 2 feet..... oz., 60c. \$0.25 \$0.10

HYACINTH BEAN (See Dolichos)

IBERIS (See Candytuft)

ICE PLANT (See Mesembryanthemum)

IMPATIENS (Sultan's Balsam)

A charming plant for house and conservatory decorations, flowering profusely and almost continuously. Large pkt. Pkt.

Holstii. Resembles <i>Impatiens Sultani</i> in leaf and shape of bloom, but flowers are larger; color, vermilion red.....	\$0.60	\$0.20
Holstii, "New Hybrids." The colors offered in these Hybrids are beautiful and of many shades.....	.60	.15
Sultani. Bright rose.....	.60	.15
Sultani Hybrida. Colors range from pale pink to dark crimson.....	.60	.15

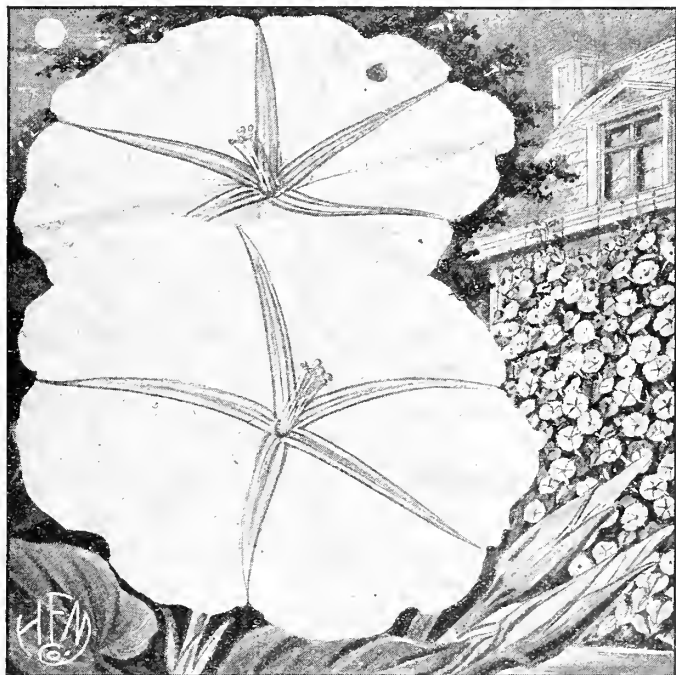

Ipomoea (Moon Flower). (Large pkt. 25c.)

IPOMOEA

	Oz.	Large Pkt.	Pkt.
Heavenly Blue (Rubra Coerulea). Beautiful, large, sky-blue flowers.....	\$1.00	\$0.30	\$0.10
Noctiflora (Moon Flower). At night and during dull days the plants are covered with an abundance of large, pure white fragrant flowers.....	60c.	.25	.10
Quamoclit Hybrida (Cardinal Climber). Fiery cardinal red.....		.75	.15
Setosa (Brazilian Morning Glory). Large leaves and bright rose-colored flowers.....	50c.	.25	.10
Mixed. Various colors.....	50c.	.25	.05

IRIS (Flowering Flag)

Kaempferi (Japanese Iris). Hardy perennial; very showy; blooms the second year from seed; mixed colors; 3 feet..... .25 .05

JOB'S TEARS (See Grasses, Page 74)

KENILWORTH IVY (Linaria Cymbalaria)

A charming, neat trailing plant, for baskets, vases, pots and rock work; flowers violet..... .60 .10



KOCHIA (Summer Cypress or Mexican Fire Bush)

Childsii. An improved strain; easily grown annual, which grows into a cypress-like hedge, with feathery green foliage; at the approach of autumn the foliage turns to a deep red color; 2 to 3 feet high; 2 to 3 feet
Large pkt. Pkt.
oz., 40c. \$0.25 \$0.05

KUDZU VINE. See Pueraria

LANTANA

Most desirable bedding plant; seeds are best germinated in a greenhouse from January till March; flowers resemble Verbenas; plants grow erect and remain in bloom all summer.

Dwarf Mixed. 10 inches high; all colors Large pkt. Pkt. \$0.25 \$0.10
Choice Mixed. 2 to 3 feet high oz., 60c. .25 .10

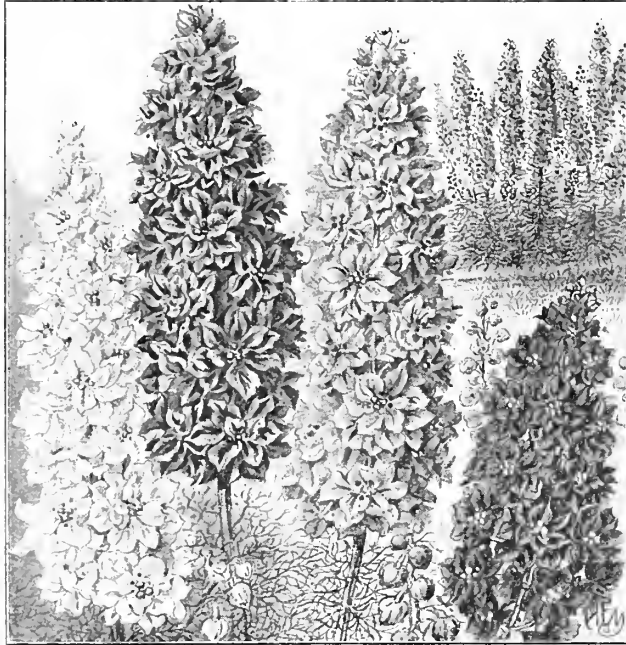

Larkspur, Double Tall Stock Flowered

LARKSPUR (Annual)

Of easy culture; seed sown early in spring will produce blooming plants by July; fern-like foliage and slender spikes with double rosette flowers; fine for cutting or garden decoration.

DWARF DOUBLE ROCKET Large Pkt. Pkt.
Mixed. A compact bushy plant with several Oz. Pkt. Pkt.
spikes of double flowers; height, 1 foot \$0.40 \$0.25 \$0.05

GIANT HYACINTH FLOWERED

The flowers are large, very double and borne on spikes resembling a double Hyacinth; 1 1/2 feet.

Mixed Colors Oz. Large Pkt. Pkt. \$0.75 \$0.25 \$0.05

TALL DOUBLE STOCK FLOWERED

Plants branch freely, bearing long spikes of beautiful double flowers; height, 2 1/2 feet.

	Oz.	Large Pkt.	Pkt.
Dark Blue	\$0.75	\$0.25	\$0.10
Lilac	.75	.25	.10
Lustrous Carmine	.75	.25	.10
Shell Pink	.75	.25	.10
Sky Blue	.75	.25	.10
White	.75	.25	.10
Mixed. All colors	.50	.25	.05

Collection, one packet each of the above 6 colors, 50c.
Exquisite (New). An extra fine variety of this popular annual; color, soft pink40 .25

For Perennial Larkspur, see Delphinium, page 70.

LAVENDER (Lavandula Vera)

Well-known, hardy perennial, bearing long spikes of fragrant blue flowers; excellent for the mixed border; 18 inches oz., 90c. .30 .10

LATHYRUS LATIFOLIUS

(Everlasting or Perennial Pea)

Showy hardy perennial climber; fine for covering walls, stumps, fences, etc. Free flowering, resembling Sweet Peas in growth, foliage and flowers; excellent for cutting; 6 to 8 feet.

	Oz.	Large pkt.	Pkt.
Crimson. Brilliant	\$0.90	\$0.30	\$0.10
Pink Beauty. Bright rosy-pink	1.25	.30	.10
White	1.25	.30	.10
Choice Mixed. All colors	.75	.25	.05

LEPTOSYNE

Maritima. Free flowering hardy annual; large, single yellow flowers, borne on long stems; excellent for cutting; 2 feet50 .10

LINARIA

Macedonica Speciosa "Nymph." Hardy perennial, blooming the first year if sown early; flowers cream color, with orange yellow spot on lower lip75 .35

LINARIA CYMBALARIA (See Kenilworth Ivy)

LINUM (Scarlet Flax)

Grandiflorum Rubrum. Ideal for bedding; dwarf and compact, with light green foliage and bright scarlet flowers; annual; 1 foot oz., 40c. .25 .05



Lobelia, Crystal Palace Compacta (Large pkt. 60c.)

LOBELIA

No garden is complete without an edging of blue Lobelia, and for a long season of bloom there is nothing that can take its place; also desirable for pots, hanging baskets, etc. Large pkt. Pkt.

Barnard's Perpetual. Deep blue with white eye; trailing; an excellent sort	\$0.50	\$0.10
Crystal Palace Compacta. Very compact; deep blue; the best for edging	.60	.10
Crystal Palace Speciosa. Of trailing habit; deep ultramarine blue; fine for vases	.30	.10
Emperor William. Flowers sky blue; plants compact	.50	.10
Gracilis. Of trailing habit, light blue	.25	.10
Sapphire. A beautiful trailing variety, of strong growth; the flowers are unusually large; color, deep blue with large clearly defined white eye	.60	.20
White Gem. Very compact; snow-white flowers	.50	.10
Mixed. All colors	.30	.05
Cardinalis (Cardinal Flower). Hardy perennial, with long spikes of cardinal red flowers. These are one of the few flowering plants that thrive in shady situations	.75	.10

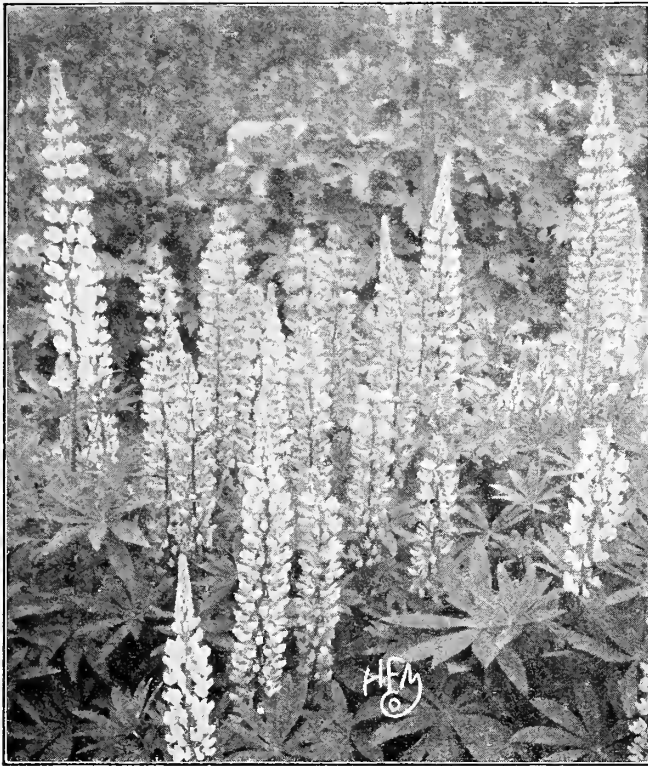

Lupinus

LUPINUS (Lupin) ANNUAL VARIETIES

Very popular, free flowering, easily grown plants of branching habit, with long spikes of pea-shaped flowers for most of their length; excellent for cutting; will bloom in six weeks after sowing; 2 feet.

Table with 4 columns: Variety, Oz., Pkt., Pkt. Prices for Rich Blue, Pink, Scarlet, White Tipped, Sky Blue, White, Yellow, and Mixed.

PERENNIAL VARIETIES

Graceful spikes with pea-shaped flowers; excellent for cutting; May and June; 2 to 3 feet.

Table with 4 columns: Variety, Large, Pkt., Pkt. Prices for Polyphyllus Blue, Polyphyllus Roseus, Polyphyllus Somerset, Polyphyllus White, and Polyphyllus Mixed.

LYCHNIS

One of the finest hardy perennials; remarkable for the brilliancy of their flowers; of easy culture; excellent for massing in large beds or borders.

Table with 4 columns: Variety, Large, Pkt., Pkt. Prices for Chalcedonica and Haageana.

MATTHIOLA

Table with 4 columns: Variety, Large, Pkt., Pkt. Price for Bicornis.

MAURANDIA

A climber of rapid growth, for baskets, vases and trellises; produces tube-shaped flowers; 10 feet.

Table with 4 columns: Variety, Large, Pkt., Pkt. Prices for Barclayana and Choice Mixed.



Marigold

MARIGOLD (Tagetes)

These are old favorite free flowering annuals, with rich and showy flowers, blooming all summer. The Tall African varieties are well adapted for large beds or mixed borders, while the Dwarf French varieties are better suited for bedding purposes.

AFRICAN VARIETIES

Table with 4 columns: Variety, Large, Pkt., Pkt. Prices for El Dorado, Lemon Queen, Orange Beauty, Orange Prince, Pride of the Garden, Large African, and Imported Collection.

FRENCH VARIETIES

Table with 4 columns: Variety, Large, Pkt., Pkt. Prices for Dwarf Gold Striped, Legion of Honor, Liliput, Dwarf French Mixed, and Imported Collection.

MARVEL OF PERU (See Next Page)

MATRICARIA. (See Feverfew)

MESEMBRYANTHEMUM

Table with 4 columns: Variety, Large, Pkt., Pkt. Prices for Cordifolium Variegatum, Crystallinum, and Tricolor.



Marvel of Peru (Four O'clock)

MARVEL OF PERU (Four O'clock)

Choice Mixed. Bushy plants of easy culture, producing hundreds of flowers during the entire summer; very showy in the garden; 2 feet. \$0.25 \$0.50

Oz. Pkt.

MIGNONETTE

Valuable for cutting on account of its fragrance; sow in succession during the whole summer; can also be grown in pots for winter and early spring flowering. Lg. pkt. Pkt.

Allen's Defiance. Spikes invariably attain a height of 12 to 15 inches; fragrant. oz., 60c. \$0.25 \$0.10

Bismarck. Compact plants of strong growth, with stout spikes of large flowers. oz., \$1.25 .30 .10

Golden Machet Large golden yellow . . . oz., 75c. .25 .10

Goliath. Giant spikes of red flowers. oz., \$1.50 .40 .10

Machet. Large reddish tinted, sweet scented flowers oz., 75c. .25 .10

Michell's Colossal. Foliage, stalks and flowers are very robust. The flower-spikes often average 18 to 24 inches; extremely fragrant. .75 .15



Mignonette, Michell's Colossal

Sweet Scented. The popular garden sort . . . oz., 25c. .15 .05
Collection. Six varieties, our selection40

MIMOSA (See Sensitive Plant)

MIMULUS

Showy, profuse flowering plants; fine for greenhouse or moist, shady situations; half hardy perennials, blooming the first year if sown early. Large pkt. Pkt.

Moschatus (Musk Plant). Fine for hanging baskets; yellow flowers; fragrant foliage; 6 inches \$0.60 \$0.10

Tigrinus (Monkey Flower). Fine mixed tigered and spotted varieties; 1 foot50 .10

MOMORDICA (See Balsam Apple)

MOONFLOWER (See Ipomoea)

MORNING GLORY (See Convolvulus)

MOURNING BRIDE (See Scabiosa)

MUSA ENSETE (Abyssinian Banana)

A handsome tropical plant for planting individually or for the centre of beds; foliage broad and massive and very effective; 10 to 15 feet. Seeds should be started in hotbed or bottom heat in greenhouse. Per 10 seeds, 30c.; 65c. per 25 seeds.

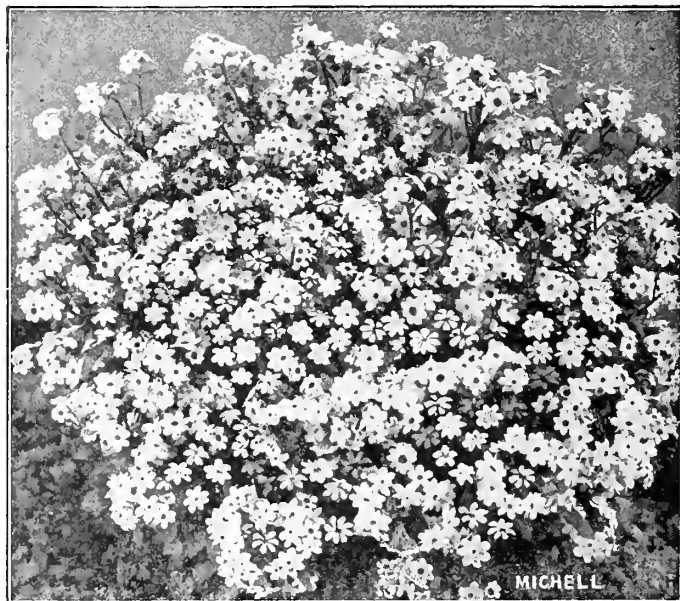

Myosotis—Alpestris Victoria

MYOSOTIS (Forget-Me-Not)

Beautiful, half hardy perennials, blooming the first year from seed; succeeding best in moist, shady situations. Sown in the spring they will flower in the fall; if wanted for early spring flowering seed should be sown in frames in July or August.

Large pkt. Pkt.

Alpestris Victoria. Of bushy habit; bearing large bright blue flowers; very fine; 6 inches \$0.40 \$0.10

Dissitiflora. Of dwarf, compact habit; deep green foliage, and attractive deep blue flowers60 .10

Eliza Fanrobert. Of strong growth, with clusters of large, bright blue flowers; 10 inches40 .10

Grandiflora Alba. Large white flowers; 8 inches . . .40 .10

Grandiflora Rosea. Large pink flowers; 8 inches . .40 .10

Michell's Winter Flowering. The finest variety for forcing; long stems, deep blue flowers75 .15

Palustris. The true Forget-Me-Not; bright blue flowers; 8 inches60 .10

Palustris Semperflorens. Dwarf; blooms the entire season; deep blue60 .10

Royal Blue. This variety belongs to the upright pillar-shaped section; deep blue flowers; 12 inches . . .30 .10

Ruth Fischer. Plant of neat, compact habit; flowers extra large and of a lovely sky blue75 .25

Choice Mixed oz., 90c. .25 .05

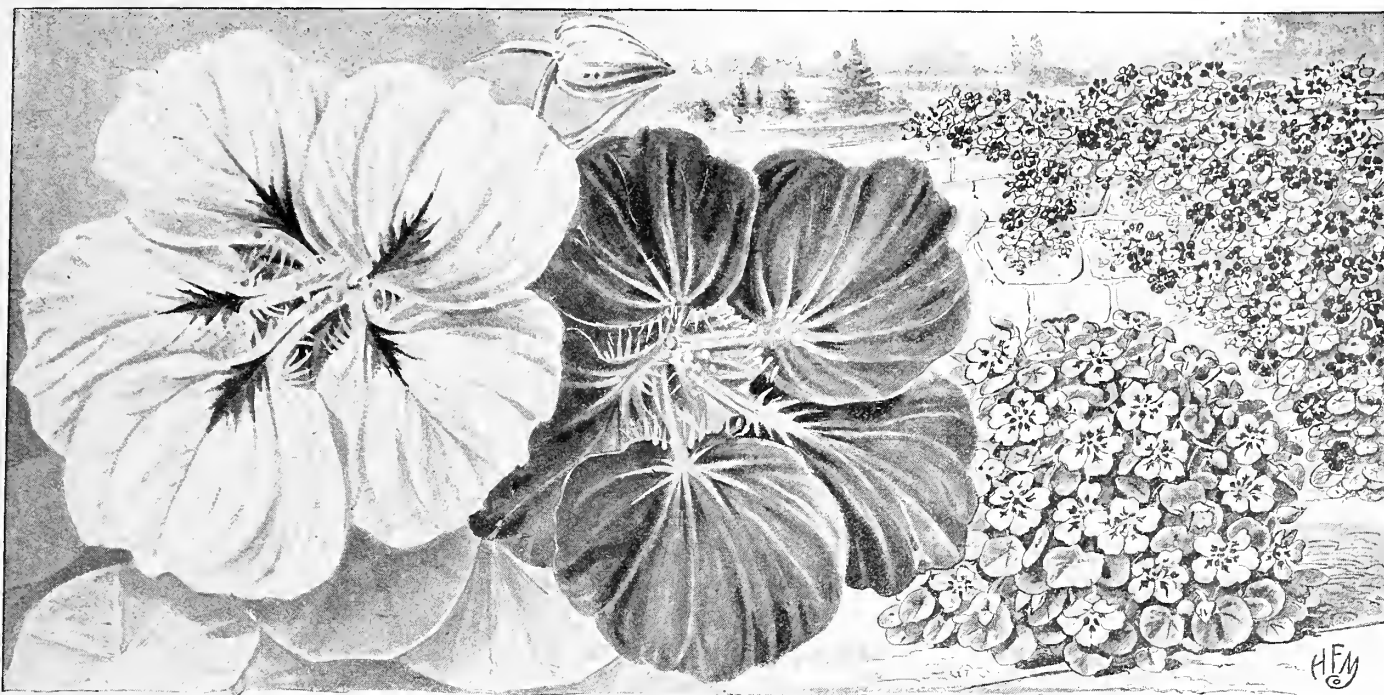

Michell's Giant Flowering Nasturtiums

Nasturtiums are among the best known and most popular of hardy annuals, and within the past few years have been greatly improved in size, as well as in colors and markings. Easily grown, and producing a great profusion of brightly colored flowers from within a few weeks after they are sown until they are killed by frost; they succeed best in rather light, well-drained soil.

DWARF OR BEDDING (Tom Thumb)

Of dwarf, compact growth; excellent for borders or for bedding, forming plants about 1 foot high by 1 foot across.

	¼ lb.	Oz.	Pkt.
Aurora. Rich yellow, veined carmine.....	\$0.60	\$0.20	\$0.05
Beauty. Yellow, with scarlet veinings.....	.60	.20	.05
Bronze. Burnished bronze color.....	.60	.20	.05
Chameleon. Produces various colors and markings on the same plant.....	.60	.20	.05
Cloth of Gold. Bright golden yellow leaves and brilliant scarlet flowers.....	.60	.20	.05
Crystal Palace Gem. Sulphur yellow, spotted maroon.....	.60	.20	.05
David Burpee Spencer. Compact plants with emerald green leaves, which are wavy and ruffled; flowers deep scarlet.....	.60	.20	.10
Empress of India. A splendid variety, with dark leaves and crimson flowers.....	.60	.20	.05
Golden King. Dark foliage; rich, golden yellow flowers.....	.60	.20	.05
Golden Queen. Foliage and flowers golden yellow.....	.60	.20	.05
King of Tom Thumbs. Dark green foliage; scarlet flowers.....	.60	.20	.05
King Theodore. Dark foliage; flowers crimson maroon.....	.60	.20	.05
Lady Bird. Rich orange yellow, with a red blotch at the base of the petals.....	.60	.20	.05
Pearl. Creamy white.....	.60	.20	.05
Pink. Soft rose color.....	.60	.20	.05
Prince Henry. Cream, spotted and tipped red.....	.60	.20	.05
Queen of Tom Thumbs, Crimson. Silver variegated foliage and rich, bright crimson flowers.....	.60	.20	.10
Scarlet. Brilliant.....	.60	.20	.05
Spotted. Rich yellow, spotted crimson.....	.60	.20	.05
Vesuvius. Salmon pink; dark leaved.....	.60	.20	.05
Yellow. Bright shade.....	.60	.20	.05

	¼ lb.	Oz.	Pkt.
Choice Mixed, Dwarf. Comprising a large variety of brilliant colors. Lb., \$1.25.....	\$0.45	\$0.15	\$0.05
Golden Foliage, Mixed. The golden yellow foliage and the flowers of many colors make a beautiful contrast.....	.60	.20	.10
Ivy Leaved Mixed. Ivy-like, deep green foliage; flowers beautifully fringed and of a remarkable range of colors.....	.60	.20	.10
Liliput Mixed. A fine variety of very dwarf and compact growth, and producing in the greatest profusion flowers of many new and beautiful colors.....	.75	.20	.05
Michell's Giant Flowering Mixed Dwarf. This is one of the finest mixtures, composed of the largest and best named varieties, and cannot be surpassed for brilliancy of color. Per lb., \$2.00.....	.60	.25	.10
Queen of Tom Thumbs, Mixed. Silver variegated foliage; flowers in a great variety of colors.....	.75	.20	.10

LOBB'S CLIMBING NASTURTIUMS (Tropaeolum Lobbianum)

These are exceedingly free flowering and of the most brilliant colors, with neat dark green foliage; excellent for window boxes, vases, hanging baskets and rockeries; also for greenhouses or conservatory during the winter; 8 to 10 feet.

	¼ lb.	Oz.	Pkt.
Asa Gray. Yellowish white.....	\$0.60	\$0.20	\$0.05
Black Prince. Dark, velvety crimson.....	.60	.20	.05
Brilliant. Glowing scarlet flowers.....	.60	.20	.05
Golden Queen. Golden yellow.....	.60	.20	.05
Roi des Noirs. Dark garnet red.....	.60	.20	.05
Spitfire. Brilliant scarlet.....	.60	.20	.05
Choice Mixed. Lobb's varieties, all colors. Per lb., \$1.25.....	.50	.15	.05
Collection. One packet each of above 6 Lobb's varieties for 25c.			

Collection. One packet each 12 dwarf varieties 50c.

For Tall or Climbing Nasturtiums, see next page.



MICHELL'S GIANT FLOWERING NASTURTIUMS—Continued

TALL OR CLIMBING

For covering trellises, fences, arbors, piazzas, trailing from vases, over rockwork, etc., nothing can equal the gorgeous effect produced by their great quantities of bloom from early summer until frost; height, 8 to 10 feet.

	¼ lb.	Oz.	Pkt.
Chameleon. Produces different colored flowers on the same plant	\$0.50	\$0.15	\$0.05
Crimson. Rich and velvety	.50	.15	.05
Hemisphaericum. Orange-salmon and scarlet	.50	.15	.05
Jupiter. Color, pure deep yellow, with crinkled petals; of immense size	.50	.15	.05
King Theodore. Dark foliage; flowers crimson maroon	.50	.15	.05
Orange. A deep shade	.50	.15	.05
Pearl. Creamy white	.50	.15	.05
Pink. Soft rose color	.50	.15	.05
Prince Henry. Cream, spotted and tipped red	.50	.15	.05
Scarlet. Very bright	.50	.15	.05
Vesuvius. Salmon pink	.50	.15	.05
Yellow	.50	.15	.05
Choice Mixed, Tall or Climbing. Lb., \$1.25	.40	.15	.05
Hybrids of Mad. Gunther. A special strain; all shades and colors. Per lb., \$1.50	.50	.20	.05
Ivy Leaved Mixed. Ivy-like, deep green foliage; flowers beautifully fringed	.60	.20	.10
Michell's Giant Flowering Mixed Tall. This mixture cannot be excelled for large size and beautiful colors of the flowers. Composed of the largest and finest varieties. Per lb., \$2.00	.60	.25	.10
Collection. One packet each, 12 varieties, 50c.			

NEMESIA

Strumosa Suttoni. A splendid annual, with large flowers varying in color from creamy white to deep orange and carmine; fine for bedding; 18 inches. Large pkt. Pkt. \$0.60 \$0.15



NIGELLA "LOVE IN A MIST"

NIEREMBERGIA

Frutescens. Half hardy perennial; excellent for greenhouse, baskets, vases or bedding out; flowers white, tinted with lilac; 1 foot Large pkt. Pkt. \$0.30 \$0.10



Nicotiana (Flowering Tobacco)

NICOTIANA (Flowering Tobacco)

Extremely showy annual plants, giving a continuous display of brilliant flowers through the summer and autumn; plants are of branching habit; 2 to 3 feet high. Large pkt. Pkt.

Affinis. Fragrant, tubular, pure white flowers	... \$0.25	\$0.10
Affinis Hybrida. Large, sweet-scented flowers; colors range through creamy white and rose tints to bright red and crimson in mixture25	.10
Sanderae. An excellent variety, growing about 2 feet high; flowers of the most handsome carmine-red color; very fragrant25	.10

NIGELLA (Love In a Mist)

Lovely garden annuals, with finely cut green foliage, and curious looking flowers and seed pods.

Damascena. Blue and white mixed; double; 1 foot	Large pkt. Pkt. \$0.25 \$0.05
Miss Jekyll. A lovely variety, with long stems, and bearing a profusion of beautiful double flowers of a clear cornflower blue; excellent for cutting; 18 inches25 .10

ORNAMENTAL GRASSES (See page 74)

PAPAVER (See Poppy)

PARIS DAISY (See Chrysanthemum)

PELARGONIUM (See Geranium)

PENNISSETUM (Ornamental Grass). See page 74.

Testimonial

Rockland, Me.
Please find enclosed check for ———, for which please send me the following seeds. The seeds I have got from you this year came up in fine shape. I have bought seeds for 35 years, and I will say your seeds are the best I ever bought.

Yours respectfully,
E. A. D.

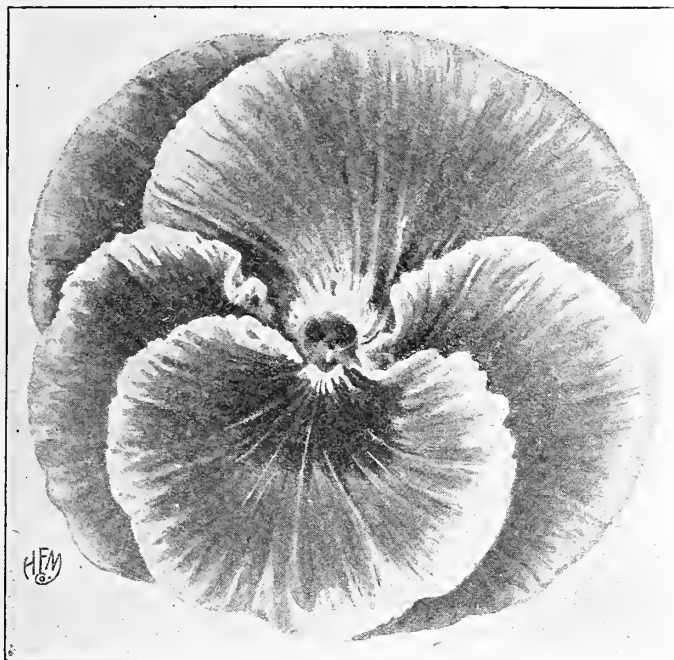

Michell's Giant Exhibition Pansy

Strictly considered, this is a biennial, but the fact that it flowers the first season from seed recommends it for an annual. There are actually three seasons in which pansies can be planted. If started in the house from February till April pansies will begin to bloom from July on; sown outdoors in May beautiful flowers are produced in the fall; sown in frames during July and August and transplanted later gives us the main crop of flowers the following spring.

PANSIES IN MIXTURES

	Large	pkt.	Pkt.
Michell's Giant Exhibition. A blending of our own containing only the very choicest secured from the leading Pansy specialists; it can be relied upon to produce flowers of immense size, very heavy texture and of the most brilliant colors. Per oz., \$10.00; \$3.00 per 1/4 oz.; per 1/8 oz., \$1.75	\$0.75		\$0.25
Bugnot, Odier and Cassier. A superb mixture of giant blotched varieties. 1/8 oz., \$1.00	.75		.25
Giant Trimardeau. Very large flowering; all colors, mixed. 1/4 oz., \$1.00	.50		.10
Mad. Perret. Early flowering; fragrant; especially rich in red shades. 1/4 oz., \$1.25	.75		.25
Masterpiece (Fringed Pansy). Beautiful rich colors; petals curled or waved. 1/8 oz., \$1.00	.75		.25
Odier or Blotched. Beautiful strain. 1/4 oz., \$1.25	.75		.15
Parisian Large Stained. Choicest colors. 1/4 oz., \$1.25	.75		.15
Triumph of the Giants Mixed. Immense flowers of great brilliancy and richness of colors, including many new and rare shades. Per oz., \$11.00; \$3.25 per 1/4 oz.; per 1/8 oz., \$2.00	.85		.50
Finest English Mixed.oz., \$2.25	.40		.10
Very Fine Mixed.oz., \$1.75	.30		.05

PENTSTEMON (Beard Tongue)

A beautiful perennial plant producing freely large spikes of handsome tubular flowers in almost every shade and color.

	Large	pkt.	Pkt.
Sensation. Plants producing large spikes of gloxinia-like flowers of the most brilliant and varied colors; will bloom the first season if sown early; 2 feet; requires protection.	\$0.50		\$0.15
New Hybrids, Mixed. Produces large spikes of handsome flowers; 3 feet.50		.10

GIANT PANSIES (Separate Colors)

A strain secured from the leading pansy specialists, and not to be compared with the ordinary Giant Trimardeau, as the flowers are of much heavier texture.

	Large	pkt.	Pkt.
Giant Prize, Azure Blue. Violet blue.	\$1.50	\$0.60	\$0.15
Giant Prize, Black Blue. Dark velvety.	1.50	.60	.15
Giant Prize, Emperor William. Ultramarine blue.	1.50	.60	.15
Giant Prize, Hortensia Red. Scarlet.	1.50	.60	.15
Giant Prize, King of the Blacks.	1.50	.60	.15
Giant Prize, Lord Beaconsfield. Violet.	1.50	.60	.15
Giant Prize, Peacock. Upper petals blue, lower petals deep claret with white margin.	1.50	.60	.15
Giant Prize, Snow Queen. Pure white.	1.50	.60	.15
Giant Prize, Striped and Mottled.	1.50	.60	.15
Giant Prize, White, with dark eye.	1.50	.60	.15
Giant Prize, Pure Yellow.	1.50	.60	.15
Giant Prize, Yellow, with dark eye.	1.50	.60	.15

SPECIAL OFFER. We will send 6 packets of any of the above varieties of Giant Pansies for 75c.; or the entire 12 pkts. for \$1.40.

PANSIES (Regular Sorts in Separate Colors)

	Large	pkt.	Pkt.
Belgian Striped. Showy.	\$2.75	\$0.40	\$0.10
Emperor William. Ultramarine blue.	2.75	.40	.10
Faust (King of the Blacks).	2.75	.40	.10
Gold Margined. Purple, golden edge.	2.75	.40	.10
Havana Brown.	2.75	.40	.10
Lord Beaconsfield. Violet.	2.75	.40	.10
Mahogany, Colored.	2.75	.40	.10
Silver Edged. Purple, silver edge.	2.75	.40	.10
Snow Queen. Pure white.	2.75	.40	.10
White, with dark eye.	2.75	.40	.10
Yellow Gem. Pure yellow.	2.75	.40	.10
Yellow, with dark eye.	2.75	.40	.10

SPECIAL OFFER. We will send 6 packets of any of the above varieties of regular sorts of Pansies for 50c.; or the entire 12 packets for 90c.

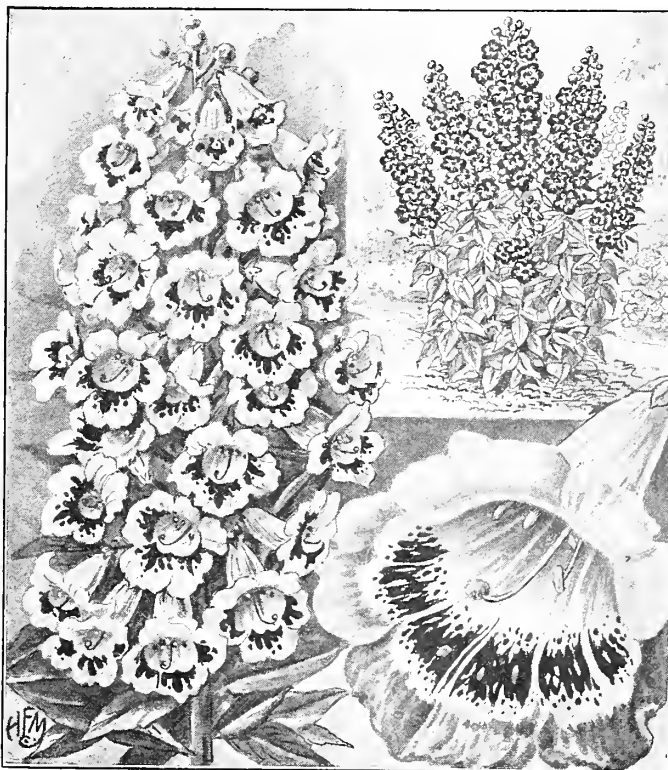

Pentstemon, New Hybrids (Large pkt. 50c.)

MICHELL'S PETUNIAS

There is no more deserving flower than the Petunia. Quick to bloom in the early summer, it gives us a bright display long after the first frost has wrought its damage. Seeds must be carefully handled, as they are extremely fine, but the plants are of easiest culture. We call especial attention to our Large Flowering strains, which for size and brilliancy of coloring cannot be surpassed.

SINGLE FLOWERED PETUNIAS

	Large pkt.	Pkt.
California Giants. One of the largest varieties; bright and desirable colors; strong robust plants...	\$0.75	\$0.25
Dwarf Inimitable. Of dwarf, compact habit; profuse bloomer; flowers striped and blotched.....	.50	.10
Grandiflora Fringed. Each petal of these giant flowers is delicately fringed, thus giving the flower a distinct appearance; all colors, mixed.....	.75	.20
Monstrosus (Michell's). Extra large flowers, many of which are elegantly fringed; the colorings, markings, veinings, etc., are superb.....	.85	.25

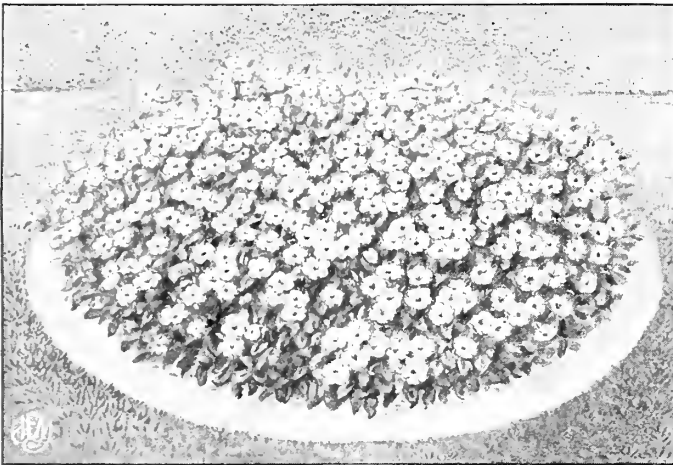

Petunia, Rosy Morn

	Large pkt.	Pkt.
Rosy Morn. Dwarf, bushy plants, bearing in great profusion brilliant rose-colored flowers with a white throat; excellent for pot culture.....	\$0.50	\$0.15
Ruffled Giants. Immense size flowers, exquisitely ruffled and frilled at edges.....	.75	.25
Snowball. A fine, compact sort, producing a profusion of satiny white flowers.....	.50	.10
Star (Howard's). A beautiful variety; produces a profusion of crimson-maroon flowers, with a distinct five-pointed white star.....	.50	.15
Choice Mixed. Striped and blotched.....oz., \$1.50	.40	.10
Fine Mixed. All colors.....oz., \$1.00	.25	.05
Imported Collection. Single fringed. 6 colors.....	.75	

Ask for Cultural Leaflet No. 205 on the growing of Petunias.

PORTLAND PETUNIAS

A new strain of Petunias for veranda boxes, pot plants or for bedding. For illustration and full description see page 55.

	Large pkt.	Pkt.
Elks' Pride. Large size; deep royal purple.....	\$1.25	\$0.40
Irvington Beauty. Flowers fringed; peach blossom color, with white throat.....	1.25	.10
Pride of Portland. Large, deep rose pink fringed flowers.....	1.25	.40
Scarlet Beauty. Flowers fringed; color, shading from cherry red to deep maroon.....	1.25	.40
White Beauty. Pure white flowers with finely fringed edges.....	1.25	.40

Practical Garden Pointers among other things gives cultural instructions on growing flowers from seed—FREE.

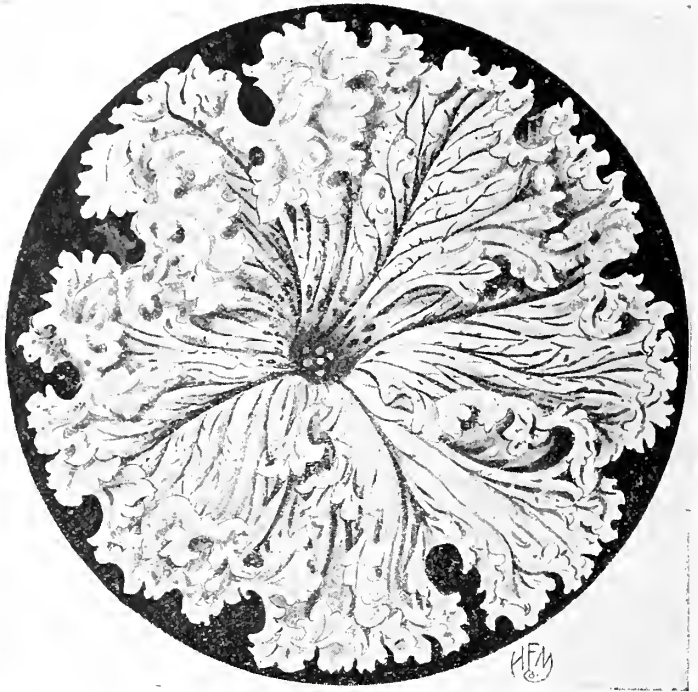

Petunia, Grandiflora, Fringed

DOUBLE FLOWERING PETUNIAS

As the seed of the double varieties is obtained by hybridization, it will not produce all double flowers, but the singles will be unusually fine. The weaker seedlings should receive great care, as they produce the finest double flowers.

	Pkt.
Double Fringed Mixed. Selected and hybridized with the greatest care; flowers of large size, beautifully fringed and embraces a splendid variety of colors in many beautiful combinations. Per 500 seeds, \$1.50.....	\$0.50



Giant Flowering, Double Petunia

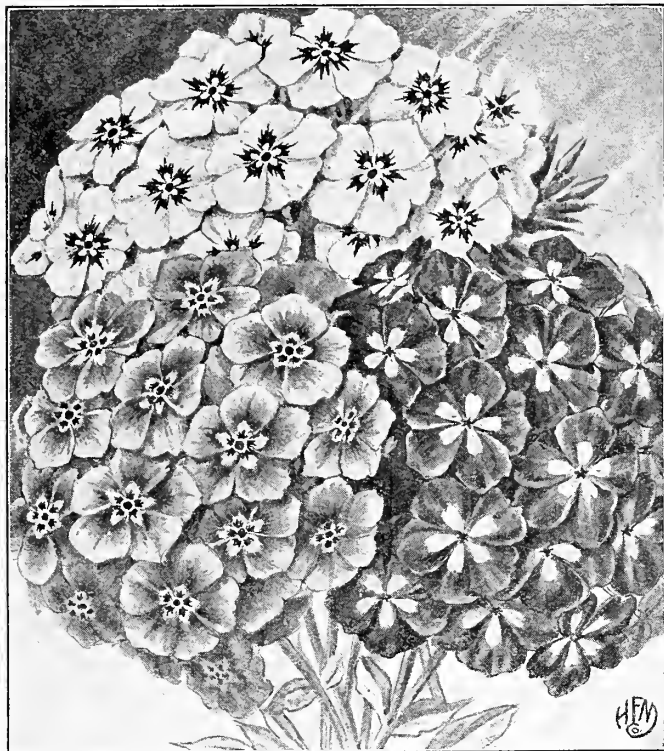

Phlox Drummondii, Grandiflora

PHLOX DRUMMONDII

One of our finest hardy annuals, and should occupy a prominent place in every garden; it is easy to grow and unequalled for its profusion of bloom, which will continue until frost; for bedding or massing nothing can surpass them for their brilliancy and richness of color. They produce immense trusses of large brilliant flowers of numberless hues.

DWARF OR COMPACT VARIETIES

The plants grow very symmetrical, in neat little bushes, 6 to 8 inches high, and are covered with flowers during the whole summer and fall. Excellent for bedding or edging.

	Large pkt.	Pkt.
Cecily, Mixed. Large flowering, dwarf compact variety, of many beautiful colors and shades.....	\$0.50	\$0.10
Fireball. Brilliant scarlet.....	.40	.10
Pink40	.10
Snowball. Pure white.....	.40	.10
Choice Mixed	¼ oz., 75c.	.40 .10

GRANDIFLORA VARIETIES

An improved strain with large heads of bloom, as well as large individual flowers; 12 to 15 inches.

	Large pkt.	Pkt.
Alba. Pure white.....	\$0.40	\$0.10
Coccinea. Brilliant scarlet.....	.40	.10
Pink40	.10
Stellata Splendens. Scarlet with white eye.....	.40	.10
Choice Mixed. All colors.....	oz., \$1.25	.40 .10
Imported Collection. 12 varieties.....		.75

PHLOX DRUMMONDII, FINE MIXED

Flowers not so large as the grandiflora type, but equally as free-flowering and effective..... oz., \$1.00 .25 .05

HARDY PHLOX

Decussata. For a gorgeous show these are the most satisfactory of all perennials; plants 2 to 3 feet high; flowers in all bright colors; seed should be sown early in spring or as soon as gathered in the autumn; mixed colors..... ¼ oz., 75c. .50 .10



PHYSOSTEGIA

(False Dragon Head)

One of the most beautiful of our summer flowering perennial border plants; it forms dense bushes, bearing freely, delicate tubular flowers; 3 to 4 feet; July-August.

Virginica. Pink. Pkt., 10c.; 30c. per large pkt.
Virginica Alba. White. Pkt., 10c.; 40c. per large pkt.

Physostegia

PINKS (See Carnations and Dianthus)

PLATYCODON (Chinese Bell Flower)

One of the best hardy perennials, bearing a profusion of large, bell-shaped flowers the whole season. Excellent for planting in borders or among shrubbery; 2 to 3 feet.

Grandiflorum Blue	\$0.40	\$0.10
Grandiflorum White40	.10

POLYANTHUS (Primula Elatior)

Beautiful spring-flowering hardy perennials, either for pot culture or for the garden; succeeds best in partial shade; 9 inches.

Gold Laced. Flowers of brilliant colors, with distinct yellow edge.....	Large pkt.	Pkt.
	\$0.60	\$0.15
Double Mixed. Beautiful colors.....	.75	.15
English Mixed. All colors.....	.60	.10

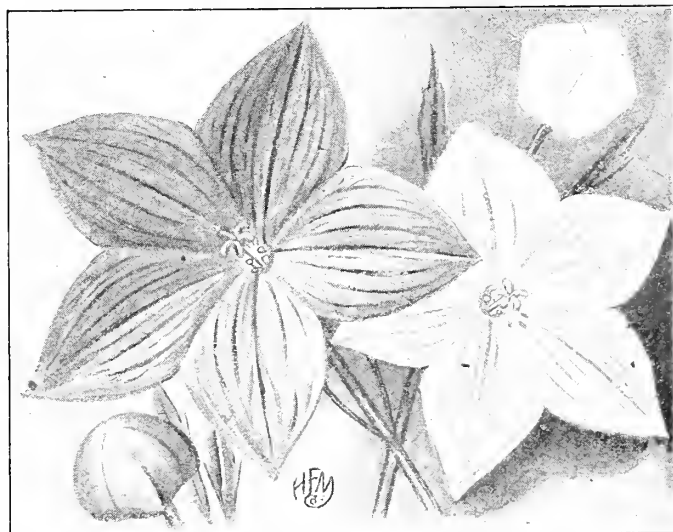

Platycodon Grandiflorum

For plants of Hardy Phlox, see page 129.

MICHELL'S POPPIES

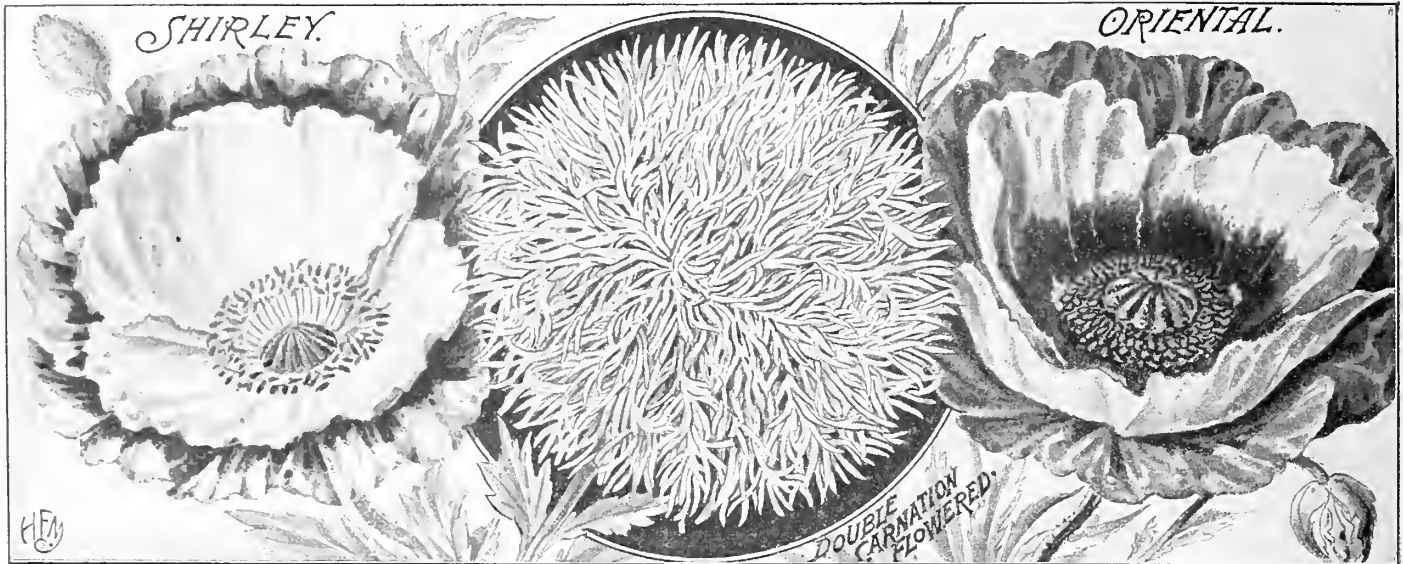

One of our favorite and most popular flowers, producing, during the blooming period, a profusion of brilliant colors and shades. Seeds should be sown as early in the spring as possible, where they are to remain, as they do not stand transplanting. Sow very thinly and barely cover the seed, press down firmly and they will come up in a few days. Several sowings may be made at intervals to have a succession of bloom.

SINGLE ANNUAL POPPIES

	Oz.	Large Pkt.	Pkt.
Admiral. A single paeony-flowered variety with large flowers of pure white with broad band of scarlet at edge of each petal.	\$0.40	\$0.25	\$0.10
Danebrog. Flowers brilliant scarlet with a silvery-white spot on each petal, forming a white cross; 2 feet.40	.25	.10
King Edward. A large flowering variety, growing about 2½ feet high; deep scarlet, shaded crimson, with dark blotch at base.40	.25	.10
Michell's Shirley. An improved strain of this lovely race of poppies varying in color from pure white and delicate pink to rosy carmine and deep crimson, in mixture. A bed of these poppies produces a gorgeous effect. If cut in the bud state and the stems put in water the flowers will open as well as on the plant.40	.25	.05
Miss Sherwood. Satiny white with upper half of corolla chamois rose.40	.25	.10
Tulip (Papaver Glaucum). One of the most brilliant varieties; resembles a large tulip; color a dazzling scarlet; 1 foot.60	.25	.10
Umbrosum. Rich vermilion with a deep shining black spot on each petal; 2 feet.40	.25	.10
Collection. One packet each above 7 varieties			.50

FLANDERS POPPY

"In Flanders fields the poppies blow
Between the crosses row on row."

This is the well known poppy of flanders field so often mentioned in songs and stories of the great war. Medium size bright scarlet flowers. Very showy when planted in masses. Pkt., 10c.; 30c. per large pkt.; oz., 75c.

AMERICAN LEGION POPPY

This single poppy of the Shirley type is a dazzling orange-scarlet of immense size, borne on long, stout stems. The plants are of erect, robust growth and the flowers are good keepers when cut in bud. Pkt., 15c.; 40c. per large pkt.

DOUBLE ANNUAL POPPIES

	Oz.	Large Pkt.	Pkt.
Carnation Flowered. Flowers of large globular form with fringed petals; mixed colors; 2 feet.	\$0.25		\$0.10
Crimson King. A dwarf variety with perfectly round flowers.40	\$0.25	.10
Fairy Blush. Flowers white, elegantly fringed and tipped with rose; 2 feet.40	.25	.10
Mikado (Striped Japanese). Double fringed flowers, white fringed and tipped with rose; 18 inches.40	.25	.10
Paeony Flowered Scarlet. Large double flowers resembling a Paeony; 2 feet.40	.25	.10
Paeony Flowered White.40	.25	.10
Paeony Flowered Yellow. Very fine.40	.25	.10
Paeony Flowered Mixed.25		.05
Improved Shirley, May Queen. A re-selected strain; large double flowers; mixed colors.30	.10
Collection, one packet each, 6 colors, 50c.			

PERENNIAL POPPIES

For permanent beds these brilliant hardy poppies stand unrivaled; for general effectiveness and brilliancy of display.

	Large Pkt.	Pkt.
Giant Scarlet (Bracteatum). Large flowers; 3 feet.	\$0.25	\$0.10
Iceland (Nudicaule). White. While these are hardy perennials, they flower the first year from spring sown seed. They are of graceful habit with fern-like foliage; the satin-like flowers are borne in endless profusion and are excellent for cutting; 12 inches	.40	.10
Iceland Yellow.40	.10
Iceland Single Mixed. Colors range from white and yellow to deep orange scarlet (¼ oz., 60c.)40	.10
Orientele. Extra large flowers; deep scarlet (¼ oz., 40c.)25	.10
Orientele, Mrs. Perry. Rich salmon pink.60	.10
Orientele, Hybrids. Flowers of large size; mixed colors (¼ oz., 60c.)40	.10

Testimonial

Worcester, Mass.

The Monstrosus Petunias which I purchased from you were the best I ever grew, especially for pot culture.

Yours truly, A. W. H.

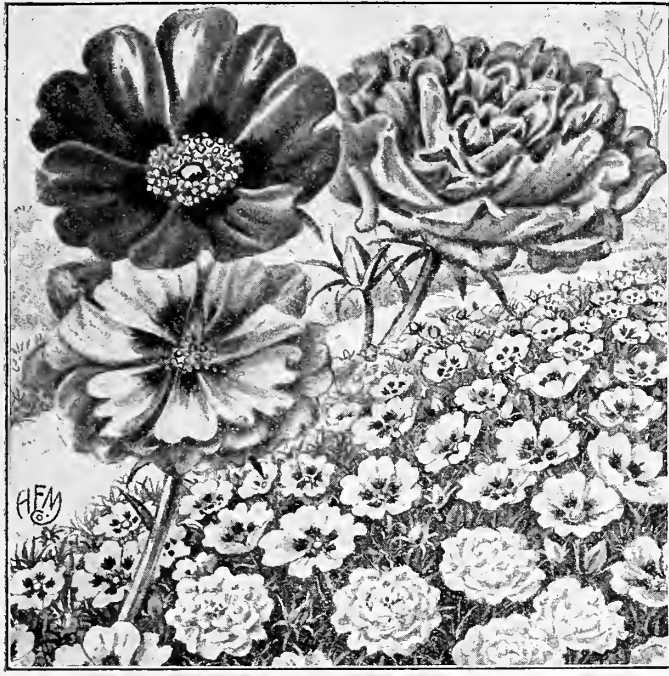

Portulaca, Single and Double

PORTULACA (Sun Plant)

Brilliant hardy annual, of easy culture; excellent for massing in beds, edging or rock work, thriving best in a light, sandy soil and a sunny situation; flowers of the brightest colors.

	Large pkt.	Pkt.
Double Mixed. All colors.....	1/4 oz., 75c.	\$0.50 \$0.10
Single Mixed. All colors.....	oz., 60c.	.25 .05
Imported Collection. 6 Double varieties.....		.50
Imported Collection. 8 Single varieties.....		.30

PRIMULA

FRINGED CHINESE PRIMROSE

These are among our finest winter and spring blooming pot plants for decorations in the home or conservatory. Our seed has been grown for us by a Primula Specialist, and cannot be excelled for size and brilliancy of colors. Our strains have won many first prizes.

	Large pkt.	Pkt.
Alba Magnifica. Large pure white flowers,.....	\$0.85	\$0.40
Chiswick Red. Brilliant red.....	.85	.40
Duchess. Large; white with zone of rosy carmine, yellow eye.....	.85	.40
Holborn Blue. A beautiful shade.....	.85	.40
Kermesina Splendens. Crimson.....	.85	.40
Rosy Morn. Delicate pink.....	.85	.40
Michell's Prize Mixture. This mixture contains only the finest sorts selected from the best strains.....	.85	.25
Imported Collection. 8 varieties.....		.75

PRIMULA OBCONICA

A beautiful and continuous blooming variety with handsome spikes of flowers and pretty foliage; elegant plants for greenhouse or light window of dwelling house.

	Large pkt.	Pkt.
Gigantea Alba. White.....	\$0.75	\$0.20
" Kermesina. Crimson.....	.75	.20
" Lilacina. Pale lilac.....	.75	.20
" Rosea. Pink.....	.75	.20
" Hybrida. Mixed.....	.75	.20
" Monster. An extra large flowering strain of this popular Primula.....		
" Apple Blossom. Soft pink.....	1.25	.40
" Kermesina. Deep crimson.....	1.25	.40
" Plathii. Brilliant deep rose.....	1.25	.40
" Rosea. Pink.....	1.25	.40
" Mixed Colors.	1.25	.40

PRIMULA—Continued
PRIMULA OBCONICA GRANDIFLORA

	Large pkt.	Pkt.
Fimbriata. Flowers fringed; mixed colors.....	\$0.75	\$0.15
Vesuvius. Deep crimson.....	.75	.25

VARIOUS SORTS

Kewensis (<i>Verbena Scented Yellow Primrose</i>). Spikes each 12 to 18 inches long; color, soft yellow; very fragrant.....	.75	.25
Malacoides. Resembles Primula Forbesi, but the flowers are much larger; if grown in a greenhouse it will bloom in four to five months after sowing and continue for a long time; color, a pretty light lilac.....	.75	.20
Malacoides Alba. Flowers pure white.....	.75	.20
Malacoides Alba Plena. A new variety with double white flowers.....	.75	.40
Malacoides Superba. Deep rosy pink; large.....		.40

HARDY PRIMROSES

Excellent early spring blooming plants; hardy, though in very cold localities they should have slight protection.

	Large pkt.	Pkt.
Veris (<i>English Cowslip</i>). This beautiful spring flowering dwarf hardy perennial bears clusters of fragrant flowers of various colors; 6 in. high.....	\$0.60	\$0.10

PUERARIA THUNBERGIANA

(Kudzu Vine)

One of the fastest growing hardy climbing plants; grows 8 to 10 feet the first year from seed; after the first year it will grow 30 to 50 feet in a season; rosy purple pea-shaped blossoms toward the end of August.....	.25	.10
---	-----	-----

San Antonio, Texas.
All the seeds I received from you have given good results. Primula Obconica raised from your seed has given in quantity and quality, brilliant results.
W. S.



Michell's Prize Chinese Primula



Pyrethrum, Doable (Large pkt. 75c.)

PYRETHRUM FOLIAGE SORTS

Foliage plants used for edging of ornamental beds; leaves are finely cut. Large pkt. Pkt.
Aureum (*Golden Feather*). Bright golden yellow foliage; 8 inches oz., 60c. \$0.25 \$0.10

FLOWERING SORTS

Handsome hardy perennial plants for the herbaceous border; flowers showy and excellent for cutting. Large pkt. Pkt.
Roseum. Flowers bright rose color; July; 2 feet \$0.60 \$0.10
Uliginosum (*Giant White Daisy*). Large, single white flowers; September; 3 to 4 feet60 .10
Hybridum Single Mixed. Large flowers ranging in color from light pink to deep red, with bright yellow centres; July; 2 feet50 .10
Hybridum Double Mixed75 .25

RESEDA (See Mignonette)

RHODANTHE (Everlasting Flower) (See page 72)

RICINUS (Castor Oil Bean)

These ornamental plants are used with great effect on lawns, as centrepieces in flowering beds such as cannas, etc. Oz. Pkt.
Borboniensis. Beautiful green foliage; 15 feet. . . . \$0.25 \$0.05
Cambodgensis. Large leaves, dark bronzy-maroon; stalk and stems nearly black; 5 feet25 .05
Gibsoni. Deep red foliage; 5 feet25 .05
Michell's Giant. Of immense size; dark brown leaves; blue-powdered stems.25 .10
Sanguineus. Blood-red stalks and clusters of red fruit; 8 feet25 .05
Zanzibariensis. Enormous leaves, varying in color from light green to purplish red; 12 feet.25 .05
Mixed. All sorts.20 .05

RUDBECKIA (Coneflower)

Large pkt. Pkt.
Bicolor Superba. A free-flowering annual; produces a profusion of yellow flowers with brown disc in centre; 2 feet \$0.25 \$0.10
Newmani. Large yellow flowers with black centre; perennial; very showy; 3 feet50 .10
Purpurea (*Giant Purple Coneflower*). Hardy perennial; large, showy, reddish purple flowers, with dark brown disc; 3 feet40 .10

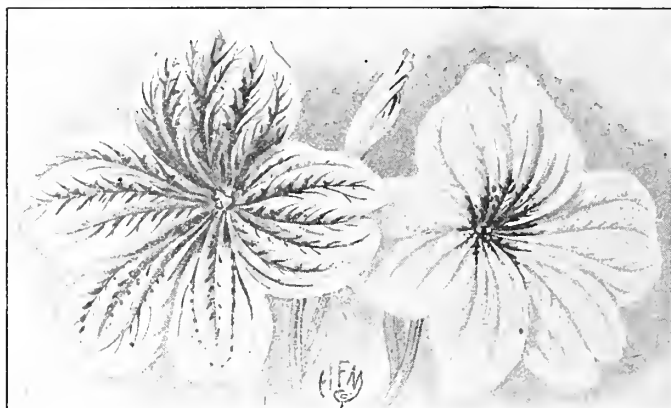

Salpiglossis

SALPIGLOSSIS (Painted Tongue)

Easy growing annual plants which have become great favorites, not only because of its easy culture, but mainly for its beautifully tinted and veined flowers; blooms from early summer until late fall; 18 inches. Large pkt. Pkt.

Crimson and Gold	\$0.50	\$0.10
Primrose50	.10
Purple and Gold50	.10
Rose and Gold50	.10
Scarlet and Gold50	.10
White and Gold50	.10
Choice Mixed . All colors30	.05
Collection . One packet each above, 6 varieties50
Emperor Mixed . A new type, having only one main stem, and bearing on its summit a large number of beautiful flowers, each one richly veined with gold.40	.10

MICHELL'S PRACTICAL GARDEN POINTERS

A publication we have compiled that contains valuable information on things floricultural, horticultural and agricultural. Ask for copy—FREE.

See pages 52 to 56 for valuable Novelties and Specialties in Flower Seeds.

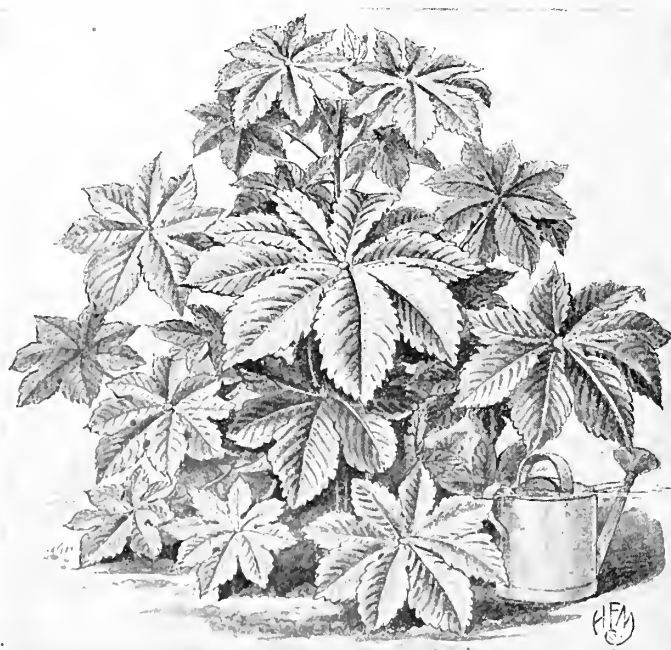

Ricinus (Castor Oil Plant)



Salvia, Bonfire

SALVIA (Scarlet Sage)

The Salvia is among our most popular and useful bedding plants. There is nothing more effective in the mid-summer or fall than these bright scarlet flowers. Seeds should be started either in the house or in hotbeds from February till April. Seed may also be sown in the open ground in May.

- America or Globe of Fire. Of dwarf, bushy, compact growth... Large pkt. Pkt. \$0.25
Bonfire (Clara Bedman). Compact bushy plants, 2 feet high... \$1.00 .40 .10
Patens. Bright blue flowers of large size; excellent for the border or greenhouse; height, 2 feet... .50 .15
Splendens. The old favorite bedding variety; tall growing plants with bright scarlet flowers; height, 3 feet... .40 .10
Zurich. One of the earliest flowering of all salvias; plants are of dwarf, bushy growth... .50 .15
Farinacea. A perennial variety, but best treated as an annual, blooming from July to frost from spring sown seed; color, light-blue; 2 feet... .40 .10

Ask for Cultural Leaflet No. 210 on the growing of Salvia.

SAPONARIA

Vaccaria. A profuse blooming annual with beautiful pink, feathery flowers; 3 feet... .25 .10

SCARLET RUNNER See Bean

SENSITIVE PLANT (Mimosa)

Pudica. Curious and interesting annual plants with pinkish white flowers; the leaves close or droop when touched or shaken; 18 inches... \$0.25 \$0.10

SHAMROCK

Dainty little house plants, easily grown from seed.

True Irish. Small leaved variety... \$0.30 \$0.10

SHASTA DAISY. See Chrysanthemum

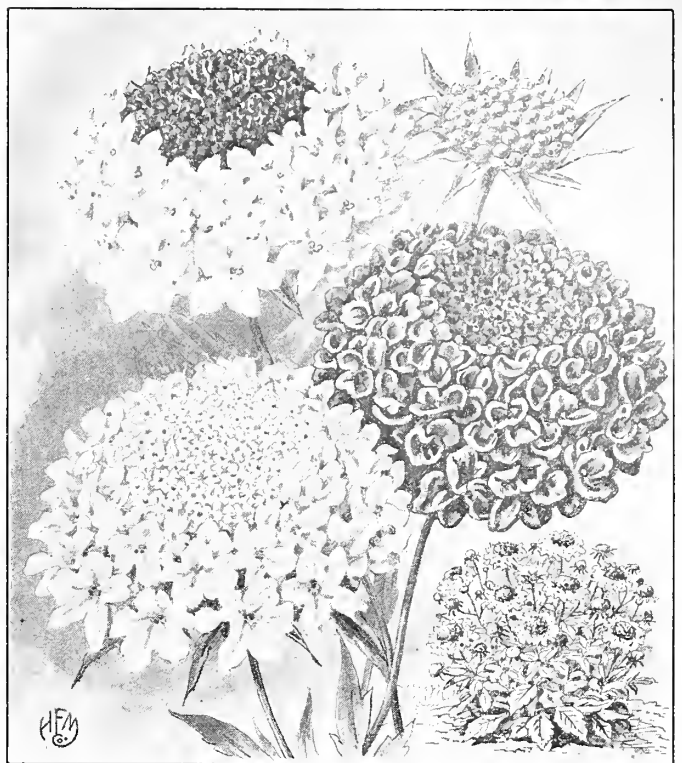

Scabiosa, Grandiflora

SCABIOSA (Mourning Bride)

Magnificent hardy annuals of easy cultivation, blooming freely through the summer and autumn. They are very decorative for beds or borders in the garden and are invaluable for cutting.

GRANDIFLORA VARIETIES (Annuals)

Flowers large and very showy, on stalks fully 2 feet high.

- Azure Fairy. Clear lavender blue... \$0.25 \$0.10
Cherry Red... .25 .10
Crimson. Rich shade... .25 .10
Flesh Pink. Delicate shade... .25 .10
King of Blacks. Deep purple... .25 .10
Pompadour. Deep purple, edged with white... .25 .10
Rose. Soft rose color... .25 .10
White... .25 .10
Collection. One packet each 6 colors... .50
Finest Mixed... oz., 60c. .25 .05
Dwarf Double Mixed. Plants grow but 12 inches high; all colors... oz., 60c. .25 .05

HARDY PERENNIAL VARIETIES

Handsome perennial border plants flowering the entire season.

- Caucasica. Soft blue; 3 feet... \$0.60 \$0.10
Caucasica Alba. Pure white... .60 .10
Japonica. Lavender blue... .25 .10

SCHIZANTHUS. See next page.

SMILAX

A greenhouse climber of great value for floral decorations; foliage light green; very graceful; seed should be soaked 24 hours in warm water before sowing; 10 feet... oz., 50c. .25 .10

SNAPDRAGON. See Antirrhinum

SOLANUM

Ornamental pot plants for winter decoration; of dwarf branching habit; dark green foliage; bears a profusion of bright berries; 1 foot. Large pkt. Pkt.

Capsicastrum (Jerusalem Cherry). Bright scarlet globular berries; 1 foot... oz., 75c. \$0.25 \$0.10

Cleveland Cherry. A grand acquisition to this class of plants; grows more compact than the above and produces the scarlet berries in greater profusion... .75 .25

MICHELL'S "DISTINCTIVE" STOCKS

The stock is one of the most popular and highly prized of our cultivated flowers, either for the garden or for pot culture. The charming colors, delightful fragrance and free blooming character, have made them favorite plants for both summer and winter cultivation. The seeds we offer are hand-saved from pot-grown specimens and will produce a large percentage of double flowers.

MICHELL'S FLOWER MARKET STOCK

This is the ideal stock for either garden, cutting or forcing under glass. Plants branch freely and produce from 10 to 15 heavy spikes of extra large perfect flowers; height, 2 feet.

	Large pkt.	Pkt.		Large pkt.	Pkt.
Blood Red	\$0.50 \$0.15	Rose Pink	\$0.50 \$0.15
Dark Blue50 .15	White50 .15
Flesh Pink50 .15	Mixed50 .15
Light Blue50 .15			

MICHELL'S EARLY FLOWERING "NICE" STOCK

An early flowering strain of branching habit; remarkably free bloomer; large, double fragrant flowers; fine for garden bedding or cutting; especially desirable for use as a pot plant. For winter blooming, sow from July to September.

	Large pkt.	Pkt.		Large pkt.	Pkt.
Abundance. Dwarf, spreading habit; carmine-rose	\$0.50 \$0.15			
Beauty of Nice. Charming delicate pink50 .15			
Crimson King. Deep red50 .15			
La Brillante. Rich brilliant crimson50 .15			
Midsummer Night. Deep, dark violet50 .15			
Monte Carlo. Canary yellow50 .15			
Mont Blanc. Pure white50 .15			
Old Rose (New). An extra fine variety50 .15			
Queen Alexandra. Delicate lavender50 .15			
Choice Mixed. All colors50 .15			

LARGE FLOWERED DWARF TEN-WEEK STOCK

This is the leading variety for bedding out, for summer blooming; also fine for pots.

	Large pkt.	Pkt.		Large pkt.	Pkt.
Blood Red	\$0.40 \$0.10	Purple	\$0.40 \$0.10
Crimson40 .10	White40 .10
Light Blue40 .10	Yellow40 .10
Pink40 .10	Mixed40 .10

VARIOUS STOCKS

	Large pkt.	Pkt.		Large pkt.	Pkt.
Brompton or Winter. Fine for forcing under glass or early summer flowering outdoors; mixed	\$0.50 \$0.10			
Dresden Perpetual. A popular variety for cutting; large spikes; color, lustrous carmine50 .15			
Princess Alice (Cut-and-Come-Again). Branching plants with double pure white flowers; fine for cutting50 .10			
Virginian Mixed. Free flowering annual. 4oz., 40c.25 .05			

Ask for Cultural Leaflet No. 211 on the growing of Stocks.

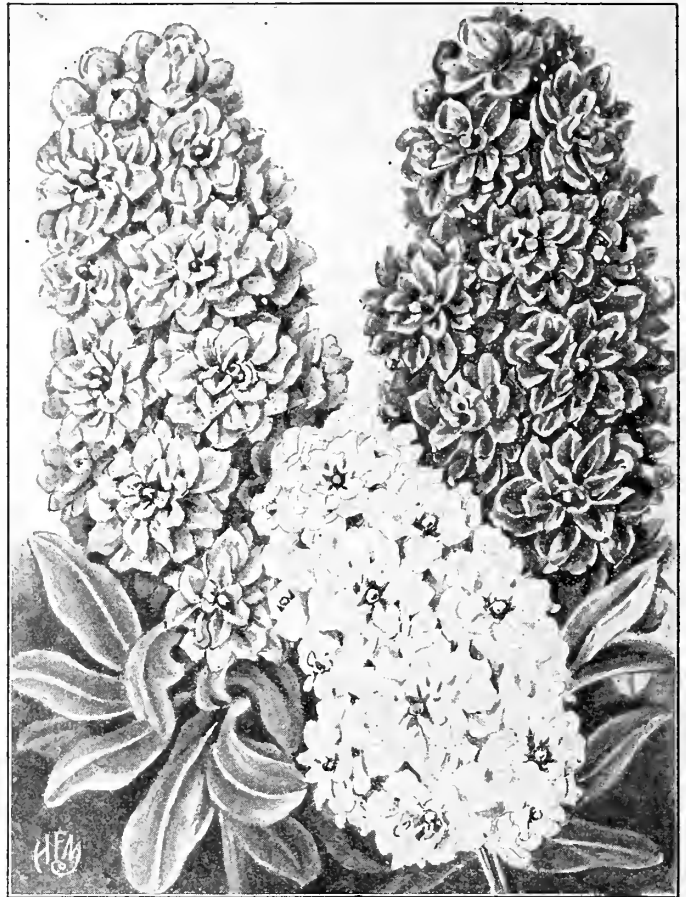

Stock, Michell's Flower Market

SCHIZANTHUS (Butterfly Flower)

One of our finest hardy annuals; of easy culture in any good garden soil and bearing a profusion of pretty butterfly-like flowers of various colors, closely resembling some species of Orchids; they are also useful as pot plants for late winter and spring blooming; for this purpose sow in autumn.

	Large pkt.	Pkt.
Garraway's Hybrids. A grand strain; flowers large; handsome markings on a white, buff, rose blue or purple ground	\$0.75 \$0.25
Hybridus Grandiflorus. Forms compact pyramidal plants covered with flowers of many shades of orchid-like appearance; 12 inches30 .10
Wisetonensis. A showy variety, largely used as a pot plant for the house or conservatory; bears a profusion of flowers ranging from white with yellow centre to pink with brown centre; 1½ feet50 .20
Mixed. Various colors25 .05

STATICE (Sea Lavender)

Latifolia. Splendid hardy perennial plants, either for the border or rockery, producing all summer panicles of small flowers, which can be dried and used for winter bouquets. Large deep-blue flowers; 1 foot..

STEVIA

Serrata. Free blooming plants for summer or winter; bearing a profusion of fragrant white flowers; excellent for cutting; 2 feet.....

STIPA (Ornamental Grass) (See page 74)

STOKESIA (See page 91)

SUNFLOWER (See page 91)



Schizanthus, Wisetonensis

Everett, Wash.
Please send us the enclosed order. Thanking you in advance, and will state that we have been using your flower seeds for a number of years with good results. E. F. C.

MICHELL'S SPENCER OR ORCHID SWEET PEAS

Nothing within recent years can approach in importance the introduction of the "Spencer" Sweet Peas. They are distinguished from the Grandiflora sorts by the enormous flowers with crinkled and wavy petals, and also from the fact that they usually bear four blossoms on a stem. The plants are of robust growth and bear the flowers on long stems.



Spencer or Orchid Sweet Peas

BLUE AND PURPLE

	½ oz.	Oz.	¼ lb.	Lb.
Captain of the Blues Spencer. Standard purple; wings blue	\$0.25	\$0.40	\$1.25	\$4.00
Royal Purple. Rich purple, one of the finest varieties	.25	.40	1.25	4.00
Wedgwood. A lovely self-blue; a beautiful and popular color	.25	.40	1.25	4.00

DEEP PINK OR ROSE

Apple Blossom Spencer. Standard light rose; wings primrose flushed rose	.25	.40	1.25	4.00
--	-----	-----	------	------

LAVENDER

Asta Ohn Spencer. Rich lavender; one of the best; flowers large	.25	.40	1.25	4.00
Flora Norton Spencer. Beautiful azure, or pale blue	.25	.40	1.25	4.00
Florence Nightingale. One of the largest and best lavenders	.25	.40	1.25	4.00

LIGHT PINK

Blanche Ferry Spencer. Large flowers; pink and white	.25	.40	1.25	4.00
Countess Spencer. A lovely clear pink, shading deeper at the edge	.25	.40	1.25	4.00
Florence Morse Spencer. Delicate blush, with deeper pink margin	.25	.40	1.25	4.00
Henrietta. Light rose pink on a cream ground	.25	.40	1.25	4.00
Hercules. Giant pure pink	.25	.40	1.25	4.00

MAROON

King Manoel. Rich maroon or deep chocolate color	.25	.40	1.25	4.00
Othello Spencer. Deep maroon	.25	.40	1.25	4.00

ORANGE AND SALMON

Helen Lewis. Orange pink; wings orange salmon	.25	.40	1.25	4.00
Illuminator. Rich salmon pink	.25	.40	1.25	4.00
Margaret Atlee. Light salmon pink on cream ground	.25	.40	1.25	4.00
Mrs. Hugh Dickson. Salmon pink on cream ground	.25	.40	1.25	4.00

PRIMROSE OR LIGHT YELLOW

Primrose Spencer. Light primrose yellow	.25	.40	1.25	4.00
--	-----	-----	------	------

SCARLET

Fiery Cross. Large; intense orange scarlet	.25	.40	1.25	4.00
King Edward Spencer. Rich, crimson scarlet; large	.25	.40	1.25	4.00
Liberty. Large flowering; crimson	.25	.40	1.25	4.00
Vermilion Brilliant. Intense scarlet	.25	.40	1.25	4.00

STRIPED AND FLAKED

Helen Pierce Spencer. White mottled light blue	.25	.40	1.25	4.00
---	-----	-----	------	------

WHITE

Constance Hinton. One of the largest varieties; flowers white; black seeded	.25	.40	1.25	4.00
King White. Gigantic flowers; pure white	.25	.40	1.25	4.00
Nora Unwin. Large pure white	.25	.40	1.25	4.00
White Spencer. Pure white; large size	.25	.40	1.25	4.00

Price, any of the above varieties, 10c. per packet.

MICHELL'S SUPERB SPENCER MIXTURE

A mixture that cannot be surpassed. Blended by ourselves from only the Giant Waved Spencer varieties in proper proportions of bright colors and including a number of new hybrids of exquisite colors and shades. Per pkt., 10c.; 25c. per oz.; ¼ lb., 75c.; \$2.50 per lb.

Our Booklet "How to Grow Sweet Peas" included in all orders if requested.

COLLECTION OF SPENCER OR ORCHID SWEET PEAS

One pkt. each 12 named varieties our selection, \$1.00.

MICHELL'S SWEET PEAS

GRANDIFLORA VARIETIES

On account of the increased demand for the Spencer or Orchid Flowered varieties we have reduced our list of Grandifloras to a few of the very best sorts.

	Oz.	¼ lb.	Lb.
Blanche Ferry. Pink and white	\$0.15	\$0.50	\$1.75
Dorothy Eckford. Large white	.15	.50	1.75
Flora Norton. Delicate lavender	.15	.50	1.75
Hon. Mrs. E. Kenyon. Primrose yellow	.15	.50	1.75
King Edward VII. Crimson scarlet	.15	.50	1.75
Lady Grisel Hamilton. Pale lavender	.15	.50	1.75
Lord Nelson. Rich navy blue	.15	.50	1.75
Lovely. Soft shell pink	.15	.50	1.75
Miss Wilmott. Deep orange pink	.15	.50	1.75
Othello. Dark maroon	.15	.50	1.75
Prima Donna. Lovely soft pink	.15	.50	1.75

Price, any of the above varieties, 10c. per packet.

MICHELL'S GILT EDGE MIXTURE

This mixture contains the Grandiflora or large flowering varieties, and represents almost every color and shade in Sweet Peas.

Price: 5c. per pkt.; per oz., 15c.; 50c. per ¼ lb.; per lb., \$1.50.

EARLY OR WINTER FLOWERING SPENCER SWEET PEAS

While the following varieties are especially adapted for forcing under glass for winter and early spring blooming, they are also valuable for outdoor culture, coming into bloom five or six weeks earlier than the regular Spencer or Orchid flowered type.

	Pkt.	½ oz.	Oz.
Asta Ohn. Rich lavender	\$0.15	\$0.60	\$1.00
Blue Bird. A charming shade of blue	.15	.60	1.00
Bohemian Girl. Beautiful deep pink	.15	.60	1.00
Cherry Ripe. Cherry or salmon cerise	.15	.60	1.00
Columbia. Salmon standard; white wings	.15	.70	1.25
Daybreak. Rose pink on cream ground	.15	.60	1.00
Enchantress. Bright rose pink	.15	.60	1.00
Fire King. Deep orange scarlet	.15	.60	1.00
Glitters (Early Royal Scot). Standard fiery orange; wings deep orange	.15	.85	1.50
Heatherbell. Mauve lavender	.15	.60	1.00
Helen Lewis. Orange pink	.15	.60	1.00
Hercules. Soft rose pink	.15	.60	1.00
Illumination. Glowing salmon cerise	.15	.60	1.00
Lavender King. Rich, deep lavender	.15	.60	1.00
Mauve Beauty. Rosy mauve	.15	.60	1.00
Meadow Lark. Rich cream	.15	.60	1.00
Melody. Rose pink on white ground	.15	.60	1.00
Miss Louise Gude. Shell pink	.15	.85	1.50
Morning Star. Deep orange scarlet in standard, with rich, orange-pink wings	.15	.60	1.00
Mrs. A. A. Skaach. Clear, light pink	.15	.60	1.00
Mrs. M. Spanolin. Pure white	.15	.60	1.00
Mrs. William Sim. Salmon pink	.15	.60	1.00
Othello. Beautiful maroon	.15	.60	1.00
Pink and White	.15	.60	1.00
Pink Beauty. Rose pink on white ground	.15	.60	1.00
Primrose Beauty. Deep primrose, flushed rose	.15	.60	1.00
Red Orchid. Bright cherry red	.15	.60	1.00
Rose Queen. Flowers are borne freely on long stems, are of large size, and usually four flowers are produced on a stem. Color a most attractive shade of pink, ¼ oz., \$1.25	.50	2.25	4.00
Sankey. Large white; black seeded	.15	.60	1.00
Snow Flake. Large pure white	.15	.60	1.00
Snowstorm. White; extra large	.15	.60	1.00
Song Bird. Pale pink on white ground	.15	.60	1.00
Songster. Rich lavender	.15	.60	1.00
Spring Maid. Light pink on white ground	.15	.60	1.00
True Blue. Charming blue self	.15	.70	1.25
Venus. White, blushed pink	.15	.60	1.00
Warbler. Rich, mauve purple	.15	.60	1.00
White Orchid. Pure white	.15	.60	1.00
Yarrowa. Flowers exquisitely waved, and of large size, many of them being duplex or double. Color, a pleasing shade of bright rose pink with lighter wings	.15	.60	1.00
Zephyr. Pale blue or lavender	.15	.60	1.00
Zvolanck's Rose. Color, rose pink	.15	.85	1.50
Mixed Colors. Winter Flowering Spencer	.10	.40	.75

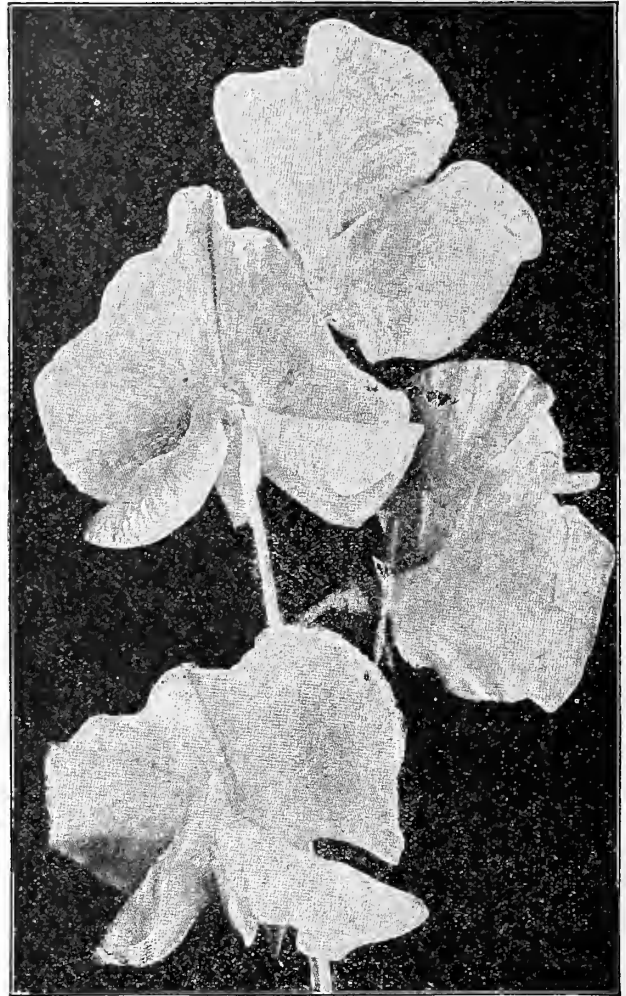

Winter Flowering Spencer or Orchid Sweet Pea

WINTER FLOWERING GRANDIFLORA

	Pkt.	Oz.	¼ lb.
Christmas Pink. Pink and white	\$0.10	\$0.30	\$0.85
Christmas White (Florence Denzer)	.10	.30	.85
Earliest of All. Pink and white	.10	.30	.85
Lavender Nora. A large flowering variety of the Unwin type	.10	.30	.85
Mont Blanc. Pure white	.10	.30	.85
Mrs. Alex. Wallace. Lavender	.10	.30	.85
Mrs. F. J. Delansky. Daybreak pink	.10	.30	.85
Mixed. Winter flowering grandiflora	.10	.20	.75

For Sweet Peas especially adapted for outdoor planting, see page 89.

NITROGEN-GATHERING BACTERIA

An ideal preparation for treating Sweet Pea Seed when planting. Makes larger and more flowers, longer stems; prolongs the blooming period.

Farmogerm. Trial size, 50c.

Mulford Culture. Trial size, 35c.

Standard Inoculating. Trial size, 25c.

Testimonial

Minneapolis, Minn.

I want to thank you very much for your prompt service and fine stock. I was under the impression that the Henry F. Michell Co. desired to give satisfaction, and you certainly warranted this plea.

S. J.

STOKESIA (Cornflower or Stokes' Aster)

Plants grow about 18 to 24 inches high, bearing freely from July to October handsome Centaurea-like blossoms, each measuring from 4 to 5 inches across; is of easy culture, and one of the most desirable plants for the hardy border; excellent for cutting.

	Large pkt.	Pkt.
Cyanea. Lavender blue.....	\$0.40	\$0.10
Cyanea Alba. Pure white.....	.50	.10

STRAWFLOWER (Helichrysum)

See Everlastings, page 72

SUNFLOWER (Helianthus)

Well known hardy annuals, the small flowering sorts being useful for cutting; the tall varieties are valuable for backgrounds.

SMALL FLOWERED SORTS

	Large pkt.	Pkt.
Cucumerifolius (<i>Miniature Sunflower</i>). Single yellow; 4 feet	oz., 40c.	\$0.25 \$0.10
Cut and Come Again. Single golden yellow flowers, with petals twisted like a Cactus Dahlia.....	.25	.10
Stella. Produces an abundance of golden yellow, single flowers with black centres; invaluable for cutting; 4 feet.....	oz., 40c.	.25 .10

LARGE FLOWERED SORTS

Chrysanthemum Flowered. Large double golden yellow flowers, resembling Chrysanthemums; 7 feet.....	oz., 40c.	.25 .10
Double Globe (<i>Globosus Fustulosus</i>). Large double yellow flowers; height 6 feet.....	oz., 40c.	.25 .05
Dwarf Double (<i>Globe of Gold</i>). Yellow flowers; 3 feet.....	oz., 40c.	.25 .05
New Red. Extra large flowers, some of which are rich chestnut red; others tipped with yellow.....	.25	.10
Oscar Wilde. Single yellow, black centre; 6 feet.....	oz., 40c.	.25 .10
Russian Mammoth. Immense single yellow flowers on tall heavy stalks; 6 feet.....	oz., 10c.	.05

PERENNIAL SORTS

Showy garden flowers blooming the whole summer.

Choice Mixed. Single flowering, hardy perennial sorts; will bloom the first year if sown early.....	.50	.10
---	-----	-----

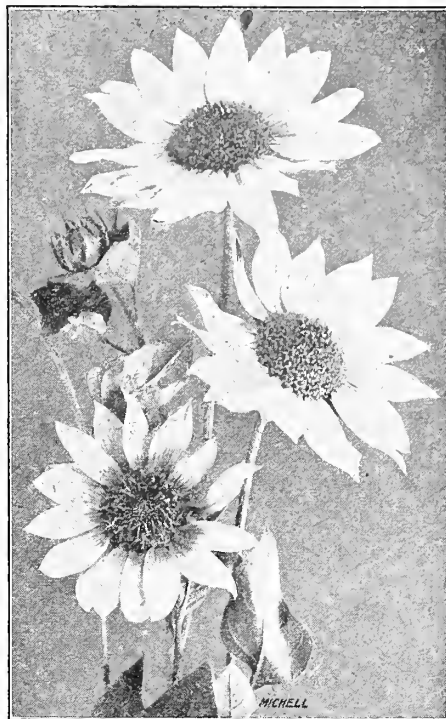

Sunflower, Stella

SWEET ROCKET (Hesperis)

Excellent for naturalizing among shrubbery or for planting in a permanent border.

Mixed. Fragrant white and purple flowers; perennial; 2 to 3 feet.....	oz., 50c.	\$0.25 \$0.15
---	-----------	---------------

SWEET SULTAN (Centaurea Moschata)

Hardy annual; fragrant flowers, resembling "Bachelor Buttons."

Mixed Colors.....	oz., 60c.	\$0.25 \$0.15
-------------------	-----------	---------------

SWEET WILLIAM (Dianthus Barbatus)

This is one of the finest of our hardy garden plants; of easy culture, thriving in any good garden soil and lasting for years. The plants grow about 1 1/2 feet high, and form fine clumps; produces fine effects in beds and shrubbery.

Auricula Flowered. A beautiful class of "eyed" single varieties, all colors mixed....	\$0.90	\$0.25 \$0.10
Single Crimson.....	.75	.25 .10
" Pink Beauty. An exceedingly pretty variety with salmon pink flowers.....	.50	.15
" Scarlet Beauty. Rich deep scarlet.....	.50	.15
" Velvety Maroon.....	.75	.25 .10
" White.....	.75	.25 .10
" Mixed. All colors.....	.60	.25 .05
Double Mixed.....	.90	.25 .10

TAGETES (Single Margold)

Signata Pumila. A fine bedding plant; flowers golden yellow; fern-like foliage....

.....	.25	.10
THALICTRUM (Meadow Rue)		
Dipterocarpum. Perennial, border plant, flowers rosy purple with yellow anthers; fine for cutting; 4 feet.....	.75	.25

THUNBERGIA (Black-Eyed Susan)

Rapid growing annual climbers, making a pretty vine for trellises, fences, rockwork, etc.; also for window boxes, hanging baskets and vases.

Mixed. All colors.....	oz., \$1.25	\$0.25 \$0.10
------------------------	-------------	---------------

TORENIA

Showy bedding plants, flowering profusely all summer; also fine for pots and baskets; height, 12 inches.

Fournieri Grandiflora. Sky-blue flowers, with dark blue spots and yellow throat.....	\$0.75	\$0.10
--	--------	--------

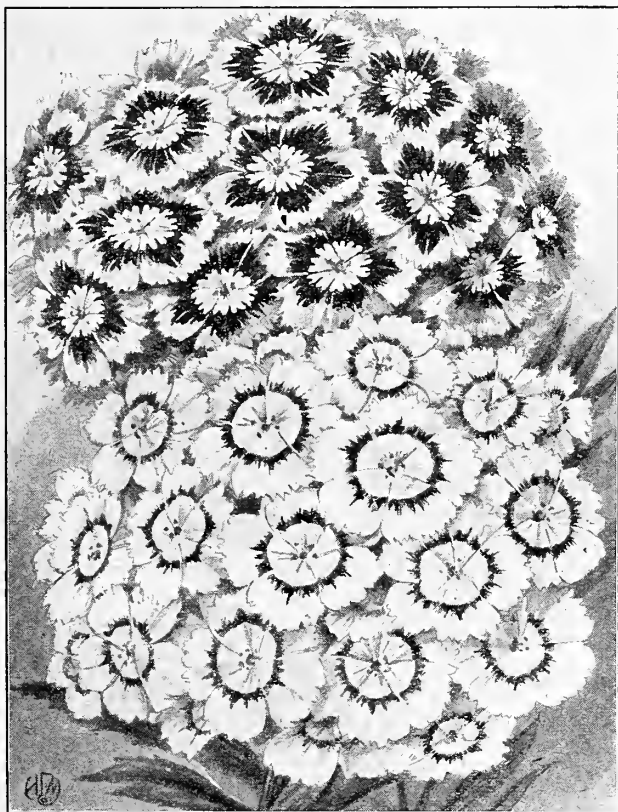

Single Sweet William

See pages 52 to 56 for valuable Novelties and Specialties in Flower Seeds.

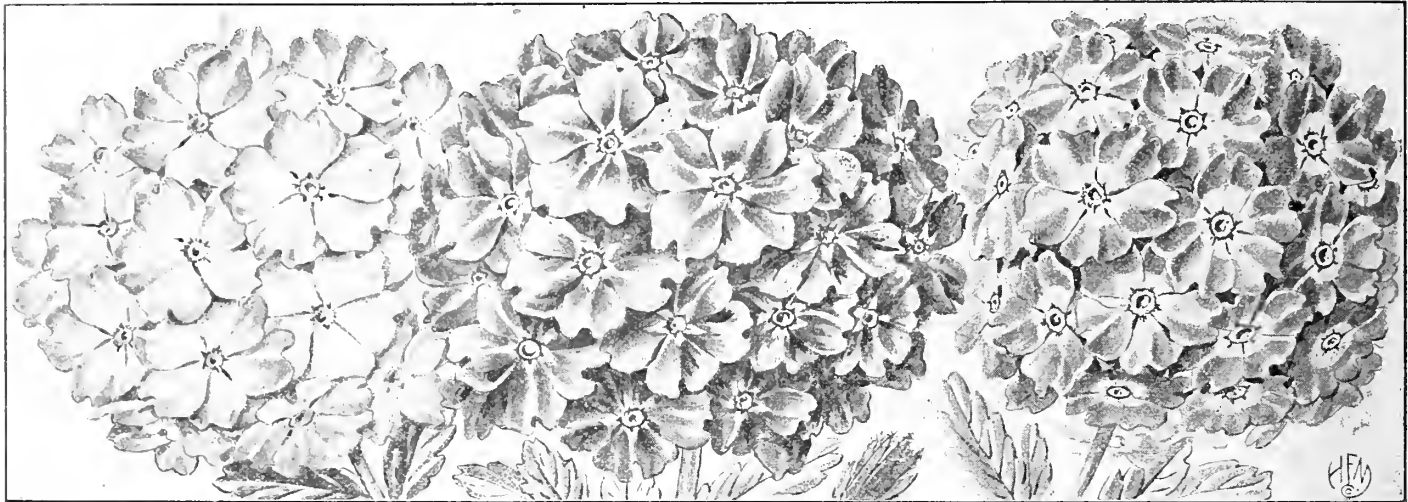

Mitchell's Mammoth Fancy Verbenas

VERBENA

An excellent annual for beds and massing, and for a gorgeous display during the summer months cannot be excelled, commencing to flower in July and continuing until frost. Our Mammoth Fancy Strain cannot be surpassed for profusion of bloom and beautiful colors and shades.

	Oz.	Large pkt.	Pkt.
Mitchell's Mammoth Fancy Blue	\$2.25	\$0.50	\$0.10
" " " Pink	2.25	.50	.10
" " " Scarlet	2.25	.50	.10
" " " Striped	2.25	.50	.10
" " " White	2.25	.50	.10
" " " Yellow	2.25	.50	.10
" " " Mixed	1.75	.50	.10

- Collection. One packet each of above 6 colors .50
- Fine Mixed. All colors 1.00 .30 .05
- Giant Flowered Mixed. A new variety of large size; flowers have extra large white eyes, making them very attractive. .75 .15
- Mammoth "Lucifer." A new variety of large size; color an intense deep cardinal scarlet throughout. .60 .15
- Lemon Scented (*Aloysia Citriodora*). An old favorite plant with delightful lemon-scented foliage; excellent for the garden in summer and pots in winter. .60 .10

VALERIANA (Garden Heliotrope)

Hardy perennial border plants; large fragrant flowers, odor resembles that of the heliotrope; 2 to 3 feet. Large pkt. Pkt. Mixed Colors . \$0.25 \$0.10

VERONICA (Speedwell)

An elegant hardy perennial plant of easy culture and free-flowering habit; of value as a cut flower or for garden. Grows bushy and produces long spikes of flowers. Large pkt. Pkt. Spicata. Long spikes of bright blue flowers; 18 in. \$0.40 \$0.10

VINCA (Madagascar Periwinkle)

Dwarf bedding plants, easily raised from seed; deep green glossy foliage and bright single blossoms of striking beauty; also suitable for pot plants; sow early. Large pkt. Pkt. Alba. White with rose eye. \$0.30 \$0.10
Alba Pura. Pure white. .30 .10
Rosea. Rose with dark eye. .30 .10
Mixed. oz., \$1.25 .25 .10

MIXED FLOWER SEEDS FOR WILD GARDEN

This mixture embraces a large number of varieties of easy-growing, beautiful and interesting annual flowers, which will furnish a profusion of bloom throughout the entire summer and autumn; many of the varieties will be found useful for cutting. Pkt., 5c.; 20c. per oz.; 1/4 lb., 60c.; \$2.00 per lb.

PERENNIAL FLOWER GARDEN MIXTURE

To create an old-fashioned wild garden or to naturalize along roads or woods we highly recommend this mixture, as it contains many varieties of the choicest old-fashioned flowers. Pkt., 10c.; 40c. per oz.; per 1/4 lb., \$1.25.

VIOLA CORNUTA (Tufted Pansies)

These resemble pansies in shape and form, with the additional quality that they are of long stems, and appear uninterruptedly from early spring till snow flies.

	Large pkt.	Pkt.
Admiration. Dark blue	\$0.60	\$0.10
Mauve Queen. Lovely mauve color	.60	.10
Perfection. Light blue	.60	.10
White Perfection. Large white	.60	.10
Mixed. All colors	.50	.10

VIOLA (Scotch Bedding Pansies)

These are very free flowering and cannot be surpassed for bedding purposes; produce larger flowers than the Viola Cornuta.

	Large pkt.	Pkt.
Golden Gem. Yellow	\$0.60	\$0.15
Lutea Splendens. Rich golden yellow	.60	.10
Snowflake. Pure white	.60	.15
Mixed. From the best named Scotch varieties	.75	.25

VIOLET Sweet Scented (Viola Odorata)

Single Blue Czar. Dark blue	.75	.10
-----------------------------	-----	-----

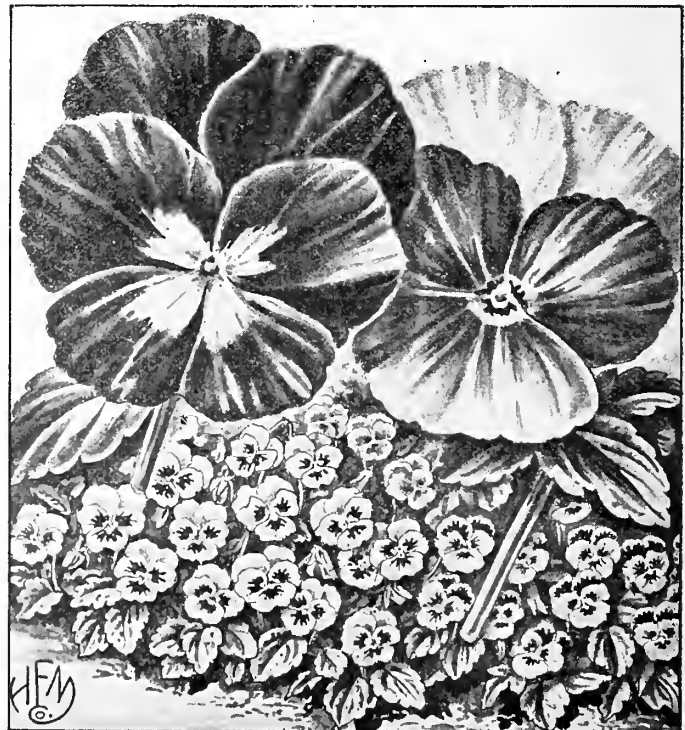

Viola, Scotch Bedding

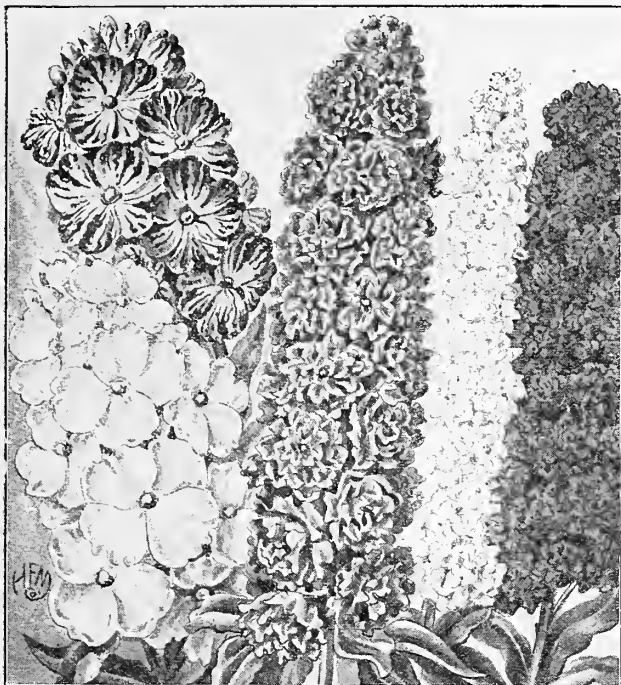

Wallflowers, Single and Double

WALLFLOWER

Half-hardy perennials of delicious fragrance. They should be protected in a cold frame in the winter and planted out in the spring; 2 feet.

	Large pkt.	Pkt.
Double Brown	\$0.60	\$0.10
“ Yellow60	.10
“ Mixed . All colors.....	.60	.10
Single Mixed	oz., 40c.	.25 .05
Imported Collection . 6 double varieties.....		.50
Imported Collection . 6 single varieties.....		.40
Paris Extra Early . A single-flowering variety, which may be treated as an annual, flowering the first year from seed; 1½ feet.	Large pkt.	Pkt.
Paris Extra Early Blood Red	\$0.25	\$0.10
Paris Extra Early Yellow25	.10
Paris Extra Early Mixed . All colors.....	oz., 60c.	.25 .10

XERANTHEMUM (Everlasting Flower)
See page 72.

MICHELL'S DISTINCTIVE ZINNIAS
(Youth and Old Age)

One of the most popular of our hardy annuals for beds, mixed borders and for cutting purposes; easy to grow in any good garden soil. They commence flowering early in the summer and continue until frost.

ROBUSTA OR GIANT DOUBLE ZINNIAS

Plants grow to a height of 2½ to 3 feet with immense perfectly double flowers; splendid for cutting or garden effect.

	Oz.	Large pkt.	Pkt.
Buttercup . Deep yellow.....	\$2.25	\$0.50	\$0.15
Crimson	1.50	.50	.15
Flesh Color	1.50	.50	.15
Golden Yellow	1.50	.50	.15
Purple	1.50	.50	.15
Rose King . Carmine rose.....	2.25	.50	.15
Salmon	1.50	.50	.15
Scarlet	1.50	.50	.15
Shrimp Pink	2.25	.50	.15
Sulphur Yellow	1.50	.50	.15
Violet	1.50	.50	.15
White	1.50	.50	.15
Mixed	1.25	.30	.10
Collection , one packet each, 8 colors.....			1.00

GIANT DAHLIA FLOWERED ZINNIAS

Flowers are distinct from the ordinary Giant Flowered class, being of a true Dahlia flowering type; flowers extra large. Plants grow from 2½ to 3 feet high. See page 56 for illustration and full description.

	Large pkt.	Pkt.
Crimson Giant	\$0.75	\$0.25
Dream . Deep lavender turning to purple.....	.75	.25
Exquisite . Light rose, centre deep rose.....	.75	.25
Golden State . Orange yellow.....	.75	.25
Old Rose75	.25
Oriole . Orange and gold.....	.75	.25
Polar Bear . Pure white.....	.75	.25
Scarlet Flame . Scarlet with blending of orange.....	.75	.25
Mixed Colors60	.15
Collection , one packet each above 8 colors.....		1.50

DWARF DOUBLE ZINNIAS

Compact bushes not over two feet in height, large double flowers.

	Oz.	Large pkt.	Pkt.
Crimson	\$0.75	\$0.25	\$0.10
Pink75	.25	.10
Salmon Rose75	.25	.10
Scarlet75	.25	.10
White75	.25	.10
Yellow75	.25	.10
Mixed60	.25	.05
Collection , one packet each above 6 colors.....			.40

VARIOUS ZINNIAS

	Oz.	Large pkt.	Pkt.
Giant Picotee, Golden Pheasant . A new variety; desirable for bedding or cutting; gold ground, each petal tipped with maroon.....	\$0.75	\$0.25	\$0.25
Giant Picotee, La France . Soft pink.....	.75	.25	.25
Giant Picotee, Mixed . Large double flowers, of many colors and shades.....	.60	.25	.25
Liliput . A small double flowering sort of dwarf habit; very effective for borders; mixed colors.....	\$1.50	.50	.10
Mexicana Perfection . Dwarf; excellent for borders; small double flowers; mixed colors.....	1.50	.50	.10
Red Riding Hood . Plants compact and covered the entire season with miniature double flowers; intense scarlet; 1 foot.....	1.00	.25	.10
Tall Double Mixed . The old fashioned tall variety; 3 feet.....	.50	.25	.05

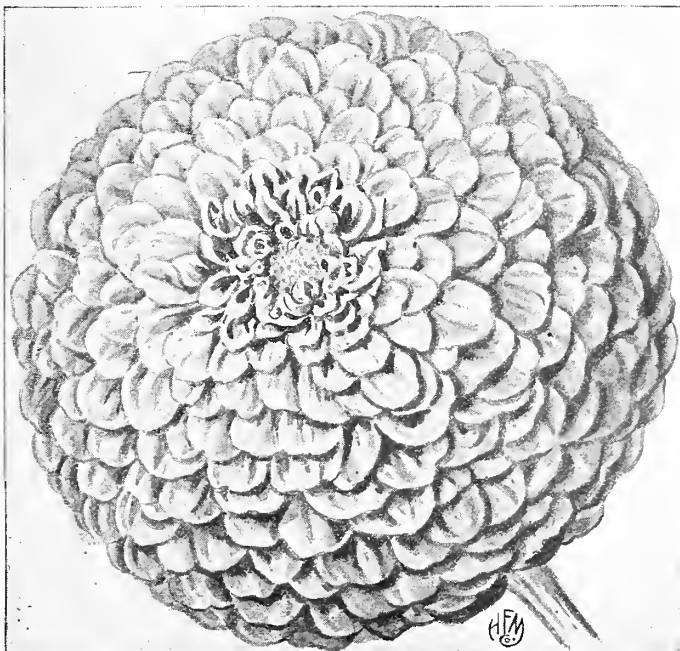

Zinnia, Giant Robusta

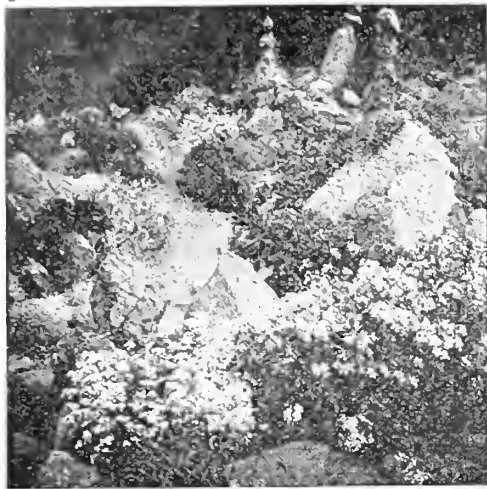

A Rock Garden planted in this fashion makes a dull spot bright

FLOWERS AND PLANTS FOR ROCK GARDENS

In the past few years Rock Gardens and Rockeries, although of ancient origin, have justly come in favor again. There are few gardens where something of this sort might not be constructed and made highly attractive, especially in locations where stones are plentiful. They may be used for hiding unsightly objects, or for giving variety to an otherwise flat and monotonous garden. Below we give a selection of plants, especially suited for this purpose.

Varieties marked S. can be furnished in seeds only; marked P., plants only; marked S. P. either plants or seeds. See index of catalog for listing.

- S. P. *Alyssum maritimum* (Sweet Alyssum)
- S. P. *Alyssum saxatile compactum* (Basket of Gold)
- S. P. *Aquilegia* (Columbine)
- S. P. *Arabis alpina* (Rock Cress)
- S. *Asperula odorata* (Woodruff)
- S. P. *Campanula carpatica* (Hare Bell)
- S. P. *Candytuft sempervirens*
- S. *Centaurea candidissima* (Dusty Miller)
- S. P. *Centaurea gymnocarpa* (Dusty Miller)
- S. P. *Cerastium tomentosum* (Snow in Summer)
- P. *Dianthus deltoides* (Maiden Pink)

- P. *Euonymus radicans*
- P. Ferns, Hardy varieties
- S. *Gypsophila elegans*
- S. P. *Gypsophila paniculata* (Baby's Breath)
- S. *Kenilworth Ivy* (*Linaria*)
- S. *Mesembryanthemum* (Ice Plant)
- S. P. *Myosotis* (Forget-me-not)
- P. *Phlox subulata* (Moss Pink)
- S. *Portulaca*
- S. P. *Primula Veris* (English Cowslip)
- S. P. *Primula Vulgaris* (English Primrose)
- P. *Sedum* (Stone Crop)
- P. *Vinca Minor* (Periwinkle)

FLOWERING PLANTS FOR CUTTING AND OPEN BORDER PLANTING

ANNUALS

- S. P. *Antirrhinum* (Snapdragon)
- S. *Arctotis* (African Daisy)
- S. P. *Asters*
- S. *Calliopsis*
- S. *Candytuft*
- S. *Celosia plumosa* (Feathered Cockscorb)
- S. *Centaurea* (Cornflower)
- S. *Chrysanthemum*
- S. P. *Cosmos*
- S. *Dimorphotheca*
- S. *Gaillardia* (Blanket Flower)
- S. *Gomphrena*
- S. *Gypsophila elegans*
- S. *Larkspur*
- S. *Lupinus*
- S. P. *Marigold*
- S. *Mignonette*
- S. *Nasturtium*
- S. *Pinks*
- S. *Salpiglossis*
- S. *Scabiosa*
- S. P. *Stocks*
- S. *Sunflower*
- S. *Sweet Peas*
- S. *Sweet Sultan*
- S. P. *Zinnia*

PERENNIALS

- S. P. *Aquilegia* (Columbine)
- S. P. *Achillea* (Sneezewort)
- S. P. *Anthemis* (Marguerite)
- S. P. *Anemone* (Windflower)
- P. *Artemisia lactiflora*
- S. P. *Aster* (Michaelmas Daisy)
- S. *Boltonia* (False Chamomile)
- S. P. *Carnation*
- S. P. *Coreopsis*
- S. P. *Chrysanthemum*
- S. P. *Delphinium*
- S. P. *Eupatorium*
- S. P. *Gaillardia grandiflora*
- S. P. *Gypsophila paniculata*
- S. P. *Geum*
- S. P. *Heliopsis*
- S. *Heuchera* (Alum Root)
- S. P. *Lupinus*
- S. P. *Phlox decussata*
- S. P. *Pentstemon*
- S. P. *Pinks*
- S. P. *Rudbeckia*
- S. P. *Shasta Daisy*
- S. P. *Stokesia*
- S. P. *Statice*
- S. *Stevia*



Borders on the edges of lawns planted in this fashion are an attraction from early Spring to Fall

For Common and Botanical Names of Popular Flowers and Plants see page 50.

A number of Plants, which are grown from Bulbs, produce splendid cut flowers, especially: *Gladiolus*, *Dahlias*, *Callas* and *Tuberoses*.



Plantings against shaded backgrounds like this accomplish wonderful effects

FLOWERS AND PLANTS FOR PARTIALLY SHADED LOCATIONS

Very few plants will flower in places, from which sunshine is entirely excluded. They may grow well enough, developing leaves, but plants of nearly all kinds must have at least some sunshine. With the exception of Hardy Ferns, which will do very well even in dense shade, the varieties named below should have sunlight for at least two hours during the day, to produce best results.

- S. P. *Aconitum* (Monk's Hood)
- S. P. *Anemone* (Windflower)
- S. P. *Aquilegia* (Columbine)
- S. *Asperula* (Woodruff)
- S. *Auricula*
- S. *Bartonia*
- S. P. *Begonia*, Tuberous-rooted (Can be furnished in Bulbs also)
- S. P. *Bellis* (Daisy)
- S. P. *Campanula* (Canterbury Bells)
- S. *Clarkia*
- S. P. *Coreopsis lanceolata*
- S. P. *Cowslip*
- S. P. *Delphinium* (Larkspur)
- S. P. *Digitalis* (Foxglove)
- P. Ferns (Hardy)
- S. *Gentiana* (Gentian)

- P. *Lily of the Valley*
- S. *Linum* (Flax)
- S. P. *Lobelia Cardinalis* (Cardinal Flower)
- S. P. *Matricaria* (Feverfew)
- S. *Mimulus* (Musk Plant)
- S. P. *Myosotis* (Forget-me-not)
- P. *Pachysandra*
- S. P. *Pansies*
- S. P. *Polyanthus*
- S. P. *Poppy* (Perennial varieties)
- S. *Schizanthus* (Butterfly-Flower)
- S. *Torenia*
- P. *Trillium* (Wood Lily)
- S. P. *Viola cornuta* (Tufted Pansies)
- S. P. *Violets*

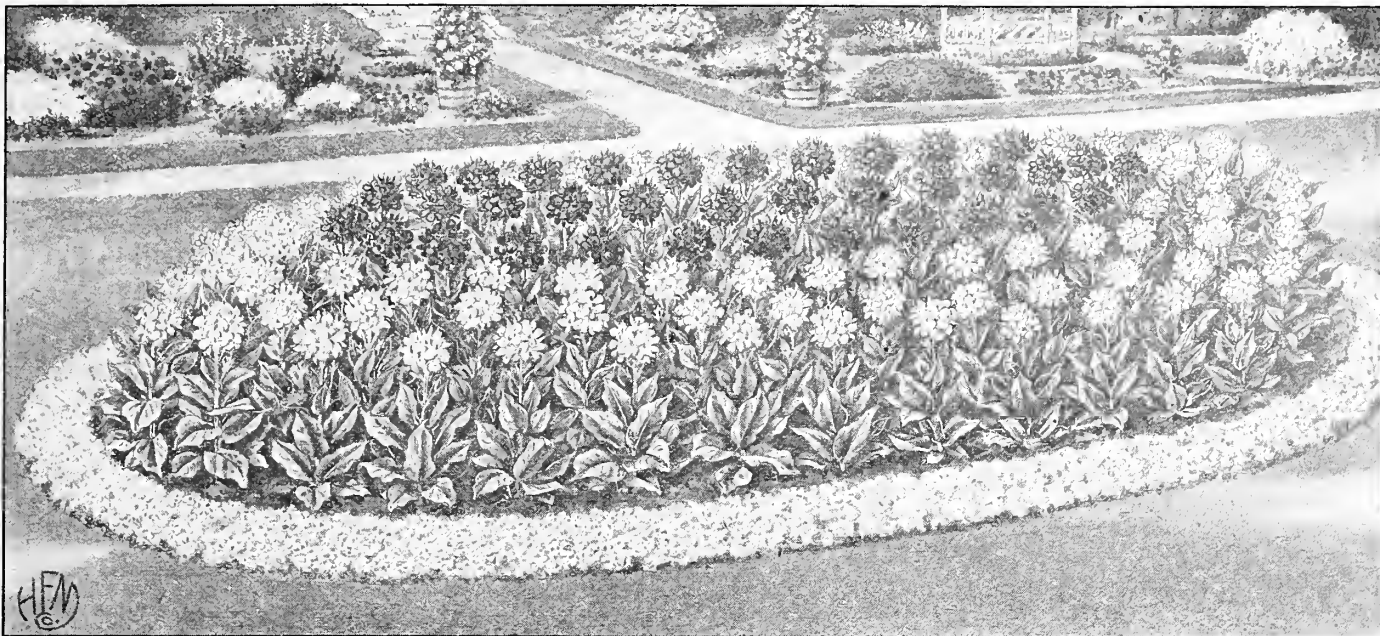

We make a specialty of growing Cannas at our Nurseries, Andalusia, Pa., where acres of them are a blaze of color throughout the summer.

Alphonse Bouvier. Rich velvety red; green foliage; 5 feet.

Austria. A tall-growing variety with gigantic blooms of a lemon chrome, spotted red; 5 feet high; foliage green.

Brandywine. Crimson; bronze foliage; 4½ feet.

Candelabra (Novelty). Three to 5 flower branches on each stalk at one time is the average; each branch is ablaze with a torch-like flame of fiery orange scarlet bloom; 5 feet; roots or plants 50c. each.

Charles Henderson. An old favorite; a fine shade of deep crimson; dwarf and compact; green foliage; about 4½ feet.

Cheerfulness. Deep orange with golden border and carmine markings, 3½ feet.

City of Portland. A glowing pink, deeper in color than its parent, Mrs. Alfred F. Conard, and the flowers are borne in greater profusion; height, 3½ ft.; foliage, green. Roots, 30c. each; doz., \$3.00; \$20.00 per 100; plants, 40c. each; doz., \$4.00; \$27.50 per 100.

Eureka. The best white; green foliage; 4 feet.

Express. One of the most satisfactory dwarf crimson cannas; a continuous bloomer; green foliage; 2½ feet high.

Firebird. This is in every respect one of the best red flowered, green-leaved Cannas. The petals measure 2½ inches and more across; the color is a brilliant scarlet, without any spots; 4½ feet.

Florence Vaughan. Yellow, spotted crimson; green foliage; 5 feet high.

Gem. Deep cream or straw yellow dotted with pale carmine; green foliage; 4½ feet.

Gladiator. Yellow spotted red; green foliage; 5 feet.

Hungaria. Plant is dwarf and of compact growth; rich peach blossom pink. It is a free, early and continuous bloomer. Foliage green and very massive; height, 3½ feet. Roots, 25c. each; doz., \$2.50; \$15.00 per 100. Plants, 35c. each; doz., \$3.50; \$20.00 per 100.

Italia. Scarlet, broadly edged yellow, orchid type; one of the best of the older sorts. Green foliage; 6 ft. high.

King Humbert. Truly a king among cannas, because of its majestic growth, which is doubly enhanced by its massive truss of coppery scarlet flowers. The foliage is deep bronze, very broad and of wonderful robust habit, growing 4½ feet high.

King Midas (New). Very large flowers of glittering yellow, on straight stems; a true Canna Aristocrat; 5 feet. Roots or plants, \$1.00 each.

Meteor. Of compact growth; broad green foliage, surmounted with large heads of bright red flowers; grows about 4½ feet high. 20c. each; doz., \$2.00; \$12.50 per 100.

Mme. Crozy. Scarlet, bordered golden yellow; green foliage; 3 feet.

Mohawk (New). Large flowers, with long petals, that withstand hot sun and rain; color is brilliant poppy red, toning to carmine; bronze foliage; 5 feet. Roots or plants, 50c. each.

Mrs. Alfred F. Conard. The gigantic flowers which are borne in immense clusters, are of delightful salmon pink, a shade which becomes more brilliant as the flower develops. Foliage is light green; 4 feet. Roots, 30c. each; doz., \$3.50; \$20.00 per 100. Plants, 40c. each; doz., \$4.50; \$27.50 per 100.

Panama. A free bloomer and of gigantic size; red, edged yellow; green foliage; 4 feet.

Richard Wallace. Light yellow; green foliage. 4½ feet.

Rosea Gigantea. The largest pink canna in existence; color, a rich rose pink; free bloomer; foliage green; height, 3½ feet. Roots, 30c. each; doz., \$3.00; \$20.00 per 100. Plants, 40c. each; doz., \$4.50; \$27.50 per 100.

The President. This splendid new variety produces immense flowers of a rich, glowing scarlet; superior in quantity and quality of bloom to any other red variety; green foliage; 3½ feet. Roots, 20c. each; doz., \$2.00; \$12.50 per 100. Plants, 35c. each; doz., \$3.50; \$20.00 per 100.

Wintzer's Colossal. Vivid scarlet flowers of immense size; profuse bloomer; height 5 feet; green foliage.

Wyoming. Orange chrome red; bronze foliage; 6½ feet.

Yellow King Humbert (Queen Helen). This is a sport of the well-known bronze-leaved variety, but this sort has green foliage; about 4½ feet high, with masses of golden yellow flowers, dotted red; occasionally some will be streaked red.

PRICES OF CANNA ROOTS

All varieties not otherwise quoted are 15c. each; doz., \$1.50; \$10.00 per 100.

PRICES OF CANNA PLANTS

Please note that the prices quoted above are for dry roots. If plants are wanted they are ready about May 10th, and will be supplied at the following prices (except where noted): 30c. each; doz., \$3.00; \$17.50 per 100. Please specify if roots or plants are wanted.

CANNAS IN MIXTURE

This mixture is made up of named sorts, but not separate; acquired while cannas are being divided for resale, it contains a splendid assortment. 12c. each; doz., \$1.25; \$8.00 per 100.

MICHELL'S NEW DAHLIAS

NEW INTRODUCTIONS



Dahlia "Henry F. Michell"

DAHLIA "HENRY F. MICHELL"

(Novelty)

A most worthy companion to the famous "Mrs. Geo. W. Elkins, Jr." (introduced in 1922) produced by the originator of the latter variety and now offered to the public for the first time. Belonging to the decorative type, it produces immense, heavy flowers of a *true brilliant scarlet* without shading, 8 to 9 inches in diameter and from 5 to 6 inches in depth. The growth of this variety is remarkable, attaining a height of eight feet without forcing; the stem is heavy and strong and the foliage dark green in color. This variety attracted attention from every visitor at the originators garden, the vivid large blooms standing out above everything else. Wherever exhibited, it was pronounced the most wonderful Dahlia ever seen. Strong field grown tubers, \$10.00 each.

DAHLIA

"MRS. GEO. W. ELKINS, JR."

(Decorative)

Introduced in 1921.

We again take pleasure in offering this beautiful variety. It is very gratifying to note how popular it has been at the recent Dahlia Shows, never failing to qualify. Its keeping qualities have commanded the attention of the florists, who are now using it for cut flower purposes. The flowers are very large and of a perfect decorative type, always full to the center. The color is a beautiful old gold suffused salmon pink, with a faint reflex of rosy pink. Strong tubers, \$5.00 each.

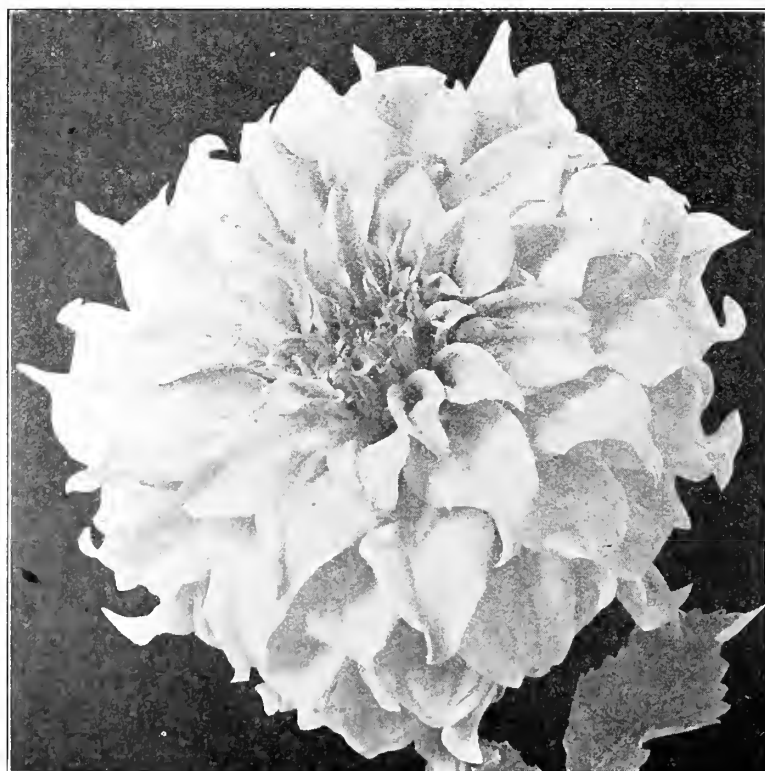

Dahlia "Mrs. Geo. W. Elkins, Jr."

MICHELL'S SUPERB DAHLIAS

NEWER AND PRIZE-WINNING VARIETIES

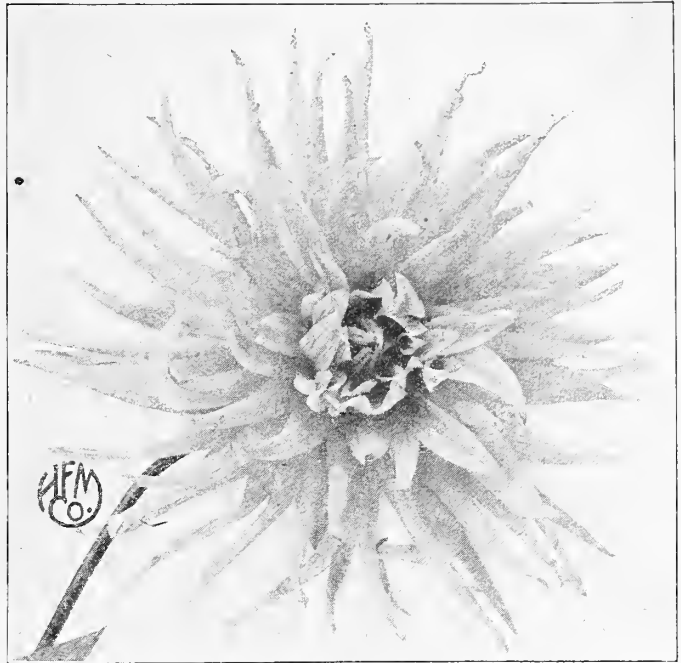

Cactus Dahlia, Mrs. Edna Spencer

- Aida** (*Decorative*). Deep maroon, large full flowers, carried on long rigid stems. Tubers, \$1.00 each.
- Amun Ra** (*Decorative*). Of immense size, and entirely new formation; resembles in color a glorious setting sun. The colors are copper and orange, deepening in center to a rich, dark, reddish bronze. Always a prize winner. Tubers, \$12.50 each.
- Attraction** (*Cactus*). One of the most desirable varieties; splendid for cutting; lilac mauve. See color plate opposite page 100. 75c. each; doz., \$7.50.
- Barbara Latz** (*Decorative*). Very large and free in bloom. It has fine upright stems and is very showy in its soft lemon tone. Tubers, \$2.50 each.
- Bonnie Brae** (*Decorative*). Cream, shaded blush pink; the flowers are true decorative form, and immense in size. A wonderful exhibition flower. Tubers, \$3.00 each.
- California Enchantress** (*Hybrid-cactus*). This novelty has immense blooms of great substance. It has a delightful shade of pale pink; the stems are fine and it is free flowering. This beautiful dahlia has given satisfaction wherever it has been grown. Tubers, \$2.50 each.
- Carolyn Wintjen** (*Decorative*). A very beautiful salmon-pink, with rose shadings; large flower with good stem. Tubers, \$3.00 each.
- City of Portland** (*Paeony*). Color is a clear, deep, rich yellow. It has every good quality; immense flowers that are graceful and artistic, held upright on long, strong stems. Tubers, \$3.50 each.
- Dorothy Potter** (*Paeony*). Very large crimson paeony flowered blooms, held on good stems. Early and profuse bloomer. Tubers, \$2.00 each.
- Francis Clark** (*Decorative*). Very large, with stems 18 to 24 inches in length, holding its gorgeous flower well above the foliage. Color, very dark, almost black. The form is of the show type, best of all the dark varieties. Tubers, \$1.00 each.
- F. W. Fellows** (*Cactus*). Large, orange-scarlet flowers, with long straight petals, often eight inches across, held on good stems. See color plate opposite page 100. Tubers, 75c. each.
- Geo. Walters** (*Hybrid-cactus*). A lovely pinkish-salmon, suffused with gold in the center; one of the largest and best varieties to date. A wonderful bloomer with long stout stems. Tubers, \$1.00 each.
- Gladys Sherwood** (*Hybrid-cactus*). A giant among pygmies; flowers often nine inches in diameter, of fine form and are held erect on strong stems; one of the best whites. Tubers, \$2.50 each.
- Gorgeous** (*Paeony*). Color, yellow shading to bright scarlet. It has tremendous size, great depth and stiff, long stems. Tubers, \$5.00 each.
- Helen Potter** (*Paeony-Decorative*). Magenta blooms of beautiful formation, somewhat resembling a hybrid-cactus. Stem is very good and the bush is ideal, producing flowers in abundance. Tubers, \$2.00 each.
- Judge Marean** (*Decorative*). This wonderful big flower is borne on fine, upright stems. The color is salmon pink, yellow, orange and red in such combination as to give an iridescent effect. Tubers, \$7.50 each.
- King Albert** (*Decorative*). Excellent cut-flower; purple. See color plate opposite page 100. \$1.00 each.
- Laddie** (*Decorative*). Soft, yellow shades of orange; the large flowers are produced in profusion, and are always held erect on strong stems. Tubers, \$3.00 each.
- Liberty Bond** (*Decorative*). A blending of buff, bronze and salmon shades, very difficult to describe. The flowers are very large and held on strong, erect stems. Tubers, \$5.00 each.
- Mrs. Carl Salbach** (*Decorative*). The immense blooms of mauve pink are held erect on extra long strong stems. A perfect exhibition and cut-flower variety. Tubers, \$3.50 each.
- Mrs. Edna Spencer** (*Cactus*). A flower of delicate and exquisite shade of orchid pink. Good formation and stem. Tubers, \$1.25 each.
- Mrs. James A. Babbitt** (*Decorative*). A deep yellow with reverse of petals overlaid with crimson, a very unusual combination of color. The blossom is very formal in formation in the early stage, but as the flower expands, the long petals curve in, showing the reverse, giving a two-tone effect. The flowers are immense in size and very attractive. Tubers, \$5.00 each.
- Mrs. R. R. Strange** (*Decorative*). A burnished copper with faint shadings of old rose and old gold, a new autumn color. Tubers, \$1.50 each.

- Pearl Almy** (*Decorative*). A very large, bright flame red flower; plant is a very sturdy, robust grower. Tubers, \$1.00 each.
- Red Flag** (*Decorative*). Bright velvety crimson red; very large and always full to the center. Tubers, \$1.00 each.
- Rookwood** (*Decorative*). A pure bright cerise rose flower of immense size and depth, held aloft on splendid straight stems. One of the very finest dahlias to date. Tubers, \$7.50 each.
- Rosa Nell** (*Decorative*). The color is a clear, bright rose; the flowers are large and come perfectly full and double until frost; good stems and habit, the color and form are rare and attract immediate attention. Tubers, \$5.00 each.
- Seguoia Gigantea** (*Decorative*). Very large buttercup yellow, with excellent habits; stout stems and gigantic blooms. Tubers, \$2.00 each.
- St. Francis** (*Decorative*). A light terra cotta; immense blooms of large size, and flowers carried on fine long stems. Tubers, \$1.00 each.
- Stunner** (*Decorative*). Immense canary yellow flowers of the finest form. Strong sturdy grower. Tubers, \$2.00 each.
- The Eagle** (*Hybrid-cactus*). Sulphur yellow, florets slightly reflexed; a large flower on long stiff stems; very prolific. Tubers, \$1.00 each.
- The Grizzly** (*Decorative*). An enormous flower of deep maroon with great depth. A prolific bloomer, with long stiff stems. Tubers, \$2.00 each.
- The Screamer** (*Paeony*). The coloring is violet purple, suffused mauve. The giant flowers are held on long, strong stems; an exceptional dahlia. Tubers, \$5.00 each.
- The U. S. A.** (*Paeony-Decorative*). A truly beautiful flower of vivid orange. The mammoth flower has a very unique formation and is held on a good stem. Tubers, \$5.00 each.
- Tom Lundy** (*Hybrid-cactus*). A very large, velvety crimson flower on good stems; prolific bloomer. Tubers, \$1.00 each.
- Valiant** (*Cactus*). A giant flower of brilliant crimson, carried on a long stem. Perfectly incurved, long and narrow florets. Tubers, \$1.00 each.
- Yellow King** (*Cactus*). Golden yellow; very large flower. See color plate opposite page 100. 75c. each.

If Bulbs, Roots or Plants are wanted by Parcel Post, add 10 per cent. to value of order to points east of the Mississippi River, and 20 per cent. to points west of the Mississippi River.

MICHELL'S SUPERB DAHLIAS

GENERAL LIST OF FINE STANDARD VARIETIES

Our list this season has again been thoroughly revised. Many of the older varieties of Dahlias have been omitted and superseded by others that are much superior. The natural season for the Dahlia to be at its best is during September and October; in fact, effort to get superior blooms, before that time should not be attempted. To get large flowers, the plants should be disbudded up to August 1st.

Spade or plow the ground to a depth of about 10 inches. As a fertilizer, use either well-rotted stable manure, or, better still, sheep manure, which should be well mixed with the soil. When the soil is properly prepared, dig a hole, 6 inches deep, in which to plant the Dahlias. The bulbs should be laid down flat and covered to a depth of 4 inches. Every Dahlia should have from 2½ to 3 feet space and at least 4 feet between the rows.

As soon as the plants are a foot above the ground they should be tied to a stake. Keep the ground well cultivated and free from weeds. Never leave more than one shoot to a plant if you want to grow exhibition flowers. You will have better plants and larger flowers.

About Dahlia Plants. It happens sometimes that there is an unusually large demand for certain varieties, and our stock of roots becomes exhausted. In such instances we will send out strong plants after May 1st, after which time most all Dahlia orders for plants are filled, these give equally as good results as tubers or roots.

A. D. Livoni (Show). Clear pink, of splendid form; an old variety, but still a favorite.

Albert Manumene (Collarette). Velvety crimson purple with white eyes.

Alewine (Pompon). Delicate pink, tinted lilac. 25c. each; doz., \$2.50.

Amber Queen (Pompon). Rich clear amber, shaded apricot.

Arbutus (Pompon). White and pink. 25c. each; doz., \$2.50.

Ariel (Pompon). Orange buff; very desirable. 25c. each; doz., \$2.50.

Attraction (Cactus). Perfect clear lilac rose flowers on long, strong stems; finest cut flower variety. 75c. each; doz., \$7.50.

Aurora (Show). Apricot colored, shaded bronze.

Avalanche (Paeony). Pure white flowers of enormous size. 75c. each; doz., \$7.50.

Ayesha (Decorative). Light yellow; long stems. 50c. each; doz., \$5.00.

Belle of Springfield (Pompon). Brick red; free bloomer.

Berch von Heemsteede (Paeony). Yellow, suffused orange.

Bianca (Cactus). Rich lavender.

Bobby (Pompon). Plum color; one of the best. 25c. each; doz., \$2.50.

Break O'Day (Decorative). Clear, sulphur yellow; robust grower. 50c. each; doz., \$5.00.

Catherine (Pompon). Bright yellow; free bloomer. 25c. each; doz., \$2.50.

Catherine Duer (Decorative). Bright red.

Chatenay (Paeony). Pink; excellent variety for cutting.

Cheerfulness (Pompon). Old gold, tipped crimson. 25c. each; doz., \$2.50.

Countess of Lonsdale (Cactus). Deep salmon pink. 40c. each; doz., \$4.00.

Country Girl (Cactus). One of the finest for cutting; golden yellow, suffused salmon pink.

Cramer Peacock (Decorative). White; free bloomer. 60c. each; doz., \$6.00.

Cream (Century). Creamy white; very attractive.

Crepuscle (Cactus). Orange yellow, deepening to deep amber buff.

Cuban Giant (Show). Garnet red; large ball shaped flowers.



Dahlia, Dream

Darkness (Pompon). Light maroon; fine for cutting. 25c. each; doz., \$2.50.

Dee-Lighted (Decorative). White; immense flowers; strong grower. 50c. each; doz., \$5.00.

Diana (Paeony). Dark red; very large flower. 50c. each; doz., \$5.00.

Dream (Decorative). Beautiful pink; fine cut flower. \$1.00 each; doz., \$10.00.

Dreer's White (Show). White, quilled petals; large flowers.

Dreer's Yellow (Show). Early and profuse bloomer; pure yellow. 50c. each; doz., \$5.00.

Elgrave (Collarette). Rich maroon, tipped white.

Elsie (Cactus). Buttercup yellow, gradually shading to amber.

Etendard de Lyon (Decorative). Magenta; very large flower. 50c. each; doz., \$5.00.

Flora (Cactus). Ivory white; excellent cut flower.

Floradora (Cactus). Wine red; fine cut flower.

Francis White (Cactus). Pure white; long stems. 40c. each; doz., \$4.00.

Fringed 20th Century (Century). Pink, shaded white, frilled petals.

F. W. Fellows (Cactus). Bright orange scarlet; huge flowers of perfect shape. 75c. each; doz., \$7.50.

Geisha Century (Single). Red and yellow.

Golden Century (Single). Golden yellow.

Golden Gate (Cactus). Rich golden yellow; large flowers. 50c. each; doz., \$5.00.

Golden West (Cactus). Shrimp pink and golden.

Grand Duke Alexis (Show). White, shaded lavender; quilled petals.

All Dahlias on this page, except otherwise noted, 35c. each; doz., \$3.50; \$25.00 per 100.

- Harzer Kind** (*Cactus*). Beautiful lavender pink.
- Hortulanus Budde** (*Paeony*). Dazzling red. 40c. each; doz., \$4.00.
- Hortulanus Fiet** (*Decorative*). Rich salmon pink. \$1.00 each; doz., \$10.00.
- Hortulanus Witte** (*Decorative*). White, free bloomer; good cut flower variety. 50c. each; doz., \$5.00.
- Jack Rose** (*Decorative*). One of the most free-flowering sorts. The flowers are rich crimson on stiff wiry stems; excellent for cutting.
- J. H. Jackson** (*Cactus*). Darkest maroon.
- John Wanamaker** (*Paeony*). Lavender pink; a good cut flower variety. 60c. each; doz., \$6.00.
- Kalif** (*Cactus*). Vivid turkey red; very large. \$1.00 each; doz., \$10.00.
- Klein Domitea** (*Pompon*). Bright amber. 25c. each; doz., \$2.50.
- Kriemhilde** (*Cactus*). Pink, white center; fine for cutting.
- Laura Barnes** (*Paeony*). Rich lavender. 60c. each; doz., \$6.00.
- Lawine** (*Cactus*). Pure white; very fine.
- Leader** (*Pompon*). Dark red, yellow toward center. 25c. each; doz., \$2.50.
- Libelle** (*Cactus*). Dark purple.
- Lyndhurst** (*Decorative*). Dazzling vermilion.
- Marjorie Castleton** (*Cactus*). Soft pink, free bloomer.
- Marie Doucet** (*Cactus*). Light pink.
- Marlby** (*Collarette*). Yellow and old rose.
- Maud Adams** (*Show*). White, lilac suffused; very fine. 40c. each; doz., \$4.00.
- Mina Burgle** (*Decorative*). Dark scarlet; a beautiful sort. 40c. each; doz., \$4.00.
- Minnie McCullough** (*Decorative*). Golden yellow, tipped bronzy red.



Show Dahlia "Maud Adams"



Pompon Dahlia "Klein Domitea"

- Mme. Eschenauer** (*Decorative*). Sulphur white, suffused lilac. 75c. each; doz., \$7.50.
- Mrs. Chas. Turner** (*Cactus*). Yellow flowers on long stems.
- Mrs. C. H. Breck** (*Cactus*). Yellow, shaded old rose; large flowers. 60c. each; doz., \$6.00.
- Mrs. F. W. Schiff** (*Decorative*). Salmon pink. \$1.00 each; doz., \$11.00.
- Mrs. Helen Hollis** (*Decorative*). Red; fine cut flower.
- Mrs. J. G. Cassatt** (*Decorative*). Bright cerise pink.
- Mrs. Warnaar** (*Paeony*). White, overlaid blush. \$1.00 each; doz., \$11.00.
- Mont Blanc** (*Cactus*). Pure white.
- Nibelungenhort** (*Cactus*). Sunflower yellow, tipped violet rose; fine cut flower. 75c. each; doz., \$7.50.
- Oregon Beauty** (*Decorative*). Oriental red. 40c. each; doz., \$4.00.
- Perle de Lyon** (*Cactus*). Pure white.
- Pink Dandy** (*Pompon*). Clear pink. 25c. each; doz., \$2.50.
- Pink Jack Rose** (*Decorative*). Clear pink.
- Pierrot** (*Cactus*). Deep amber, usually tipped white. 75c. each; doz., \$7.50.
- President Lincoln** (*Paeony*). Purple, yellow center. \$1.00 each; doz., \$10.00.
- Pride of California** (*Decorative*). Bright scarlet flowers of immense size. \$1.50 each; doz., \$15.00.
- Princess Victoria Louise** (*Show*). Pure yellow.
- Prince of Yellows** (*Cactus*). Clear yellow.
- Princess Juliana** (*Paeony*). Pure white; fine cut flower.
- Professor Mansfield** (*Decorative*). Yellow, red and white.

Prices of all Dahlias offered on this page, except where noted, 35c. each; doz., \$3.50.

If Bulbs, Roots or Plants are wanted by Parcel Post, add 10 per cent. to value of order to points east of the Mississippi River, and 20 per cent. to points west of the Mississippi River.

MICHELL'S SUPERB DAHLIAS



Collarette type of Dahlia

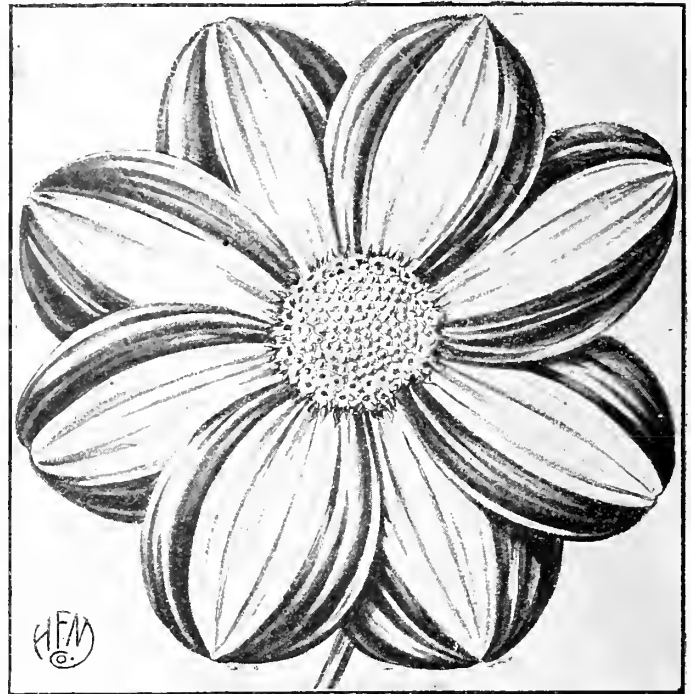

Single Dahlia "Twentieth Century"

Queen Elizabeth (Paeony). Beautiful rosy mauve; free bloomer. 50c. each; doz., \$5.00.

Queen Emma (Paeony). Hollyhock pink.

Queen Mary (Decorative). Cerise pink.

Queen of Hearts (Cactus). White, with creamy yellow at base.

Queen Victoria (Show). Yellow; free bloomer and long stemmed.

Queen Wilhelmina (Paeony). Pure white; free bloomer. 40c. each; doz., \$4.00.

Rautendelein (Single). Red tipped white.

Red Grand Duke (Show). Cardinal red.

Red Hussar (Show). Red; good bloomer with long stems.

Rene Cayeux (Cactus). Red; an extra fine variety.

Rhaden Kartini (Decorative). Old rose, center gold. 75c. each; doz., \$7.50.

Rheinkoenig (Cactus). A splendid exhibition sort; giant flowering pure white.

Rosella (Pompon). Yellow and old rose.

San Toy (Pompon). White, heavily tipped carmine.

Sequoia (Cactus). Fawn yellow; free bloomer.

Spy (Pompon). Red; splendid for cutting. 25c. each; doz., \$2.50.

Sylvia (Decorative). Deep pink; free bloomer; fine for cutting.

Thais (Cactus). White, shaded lilac.

T. G. Baker (Cactus). Golden yellow.

Thos. Oberlin (Cactus). Intense scarlet.

Thompson (Decorative). Brilliant scarlet; robust grower.

Tillamook (Decorative). Lavender with white quilled petals.

Twentieth Century (Century). White at base and lips, center of petals is a delicate blush rose.

Vivian (Show). Lavender and white.

Vivid (Pompon). Vivid red; free bloomer. 25c. each; doz., \$2.50.

White Century (Century). White; good bloomer.

White Swan (Show). Pure white; flowers borne on long, stiff stems.

Wodan (Cactus). Salmon; a splendid cut flower variety with immense flowers. 60c. each; doz., \$6.00.

Wolfgang von Goethe (Cactus). Apricot shaded carmine. 60c. each; doz., \$6.00.

Yellow Duke (Decorative). Primrose yellow; very large.

See page 97 for New Giant Prize Winning Dahlias

DAHLIAS TO COLOR

Though named sorts, these are not labeled to variety, furnished in the following types and colors: Cactus, Show, Single and Decorative; in Pink, White, Yellow and Scarlet, each separate. Price, 25c. each; doz., \$2.50; \$18.00 per 100.

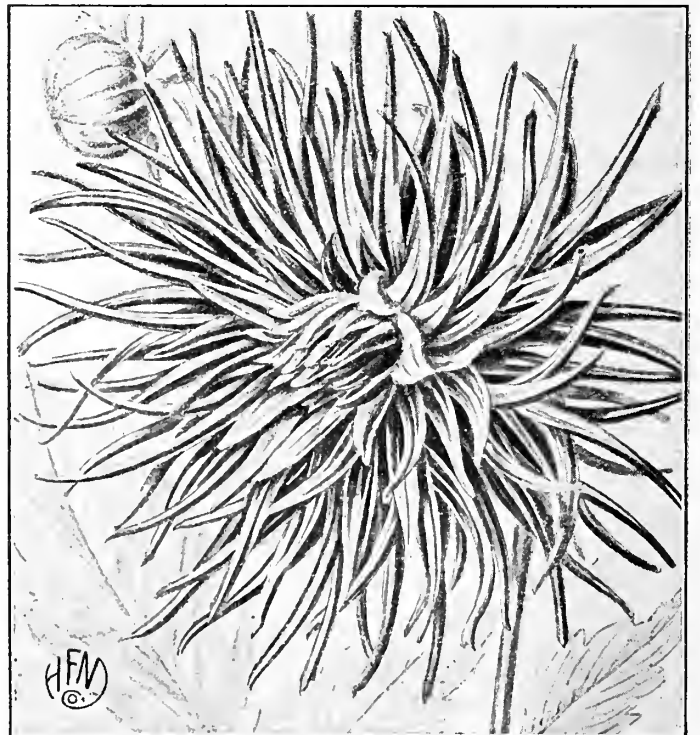

Cactus Dahlia Thos. Oberlin

Prices of all Dahlias offered on this page, except where noted, 35c each; doz., \$3.50; \$25.00 per 100.

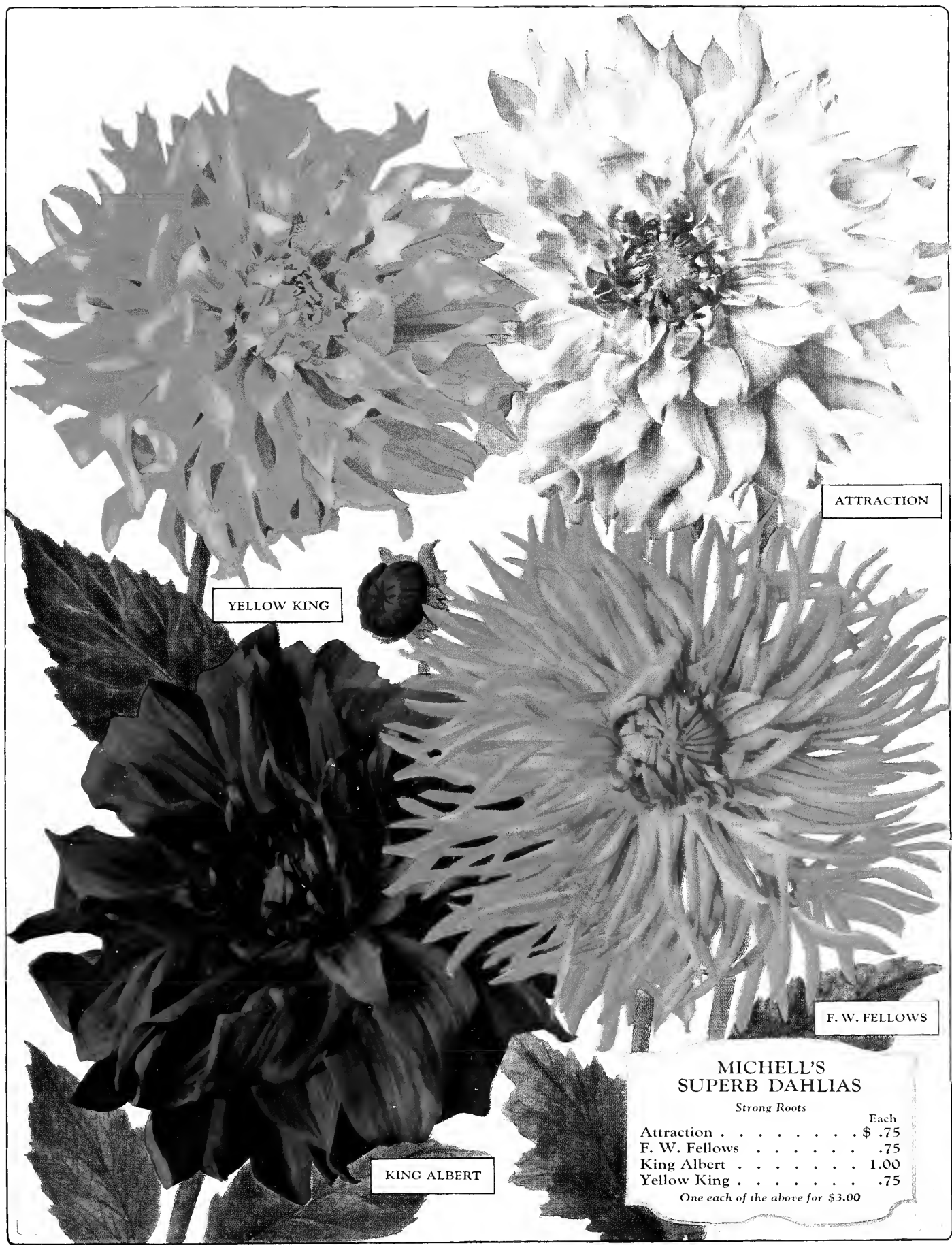

ATTRACTION

YELLOW KING

F. W. FELLOWS

KING ALBERT

**MICHELL'S
SUPERB DAHLIAS**

Strong Roots

	Each
Attraction	\$.75
F. W. Fellows75
King Albert	1.00
Yellow King75

One each of the above for \$3.00

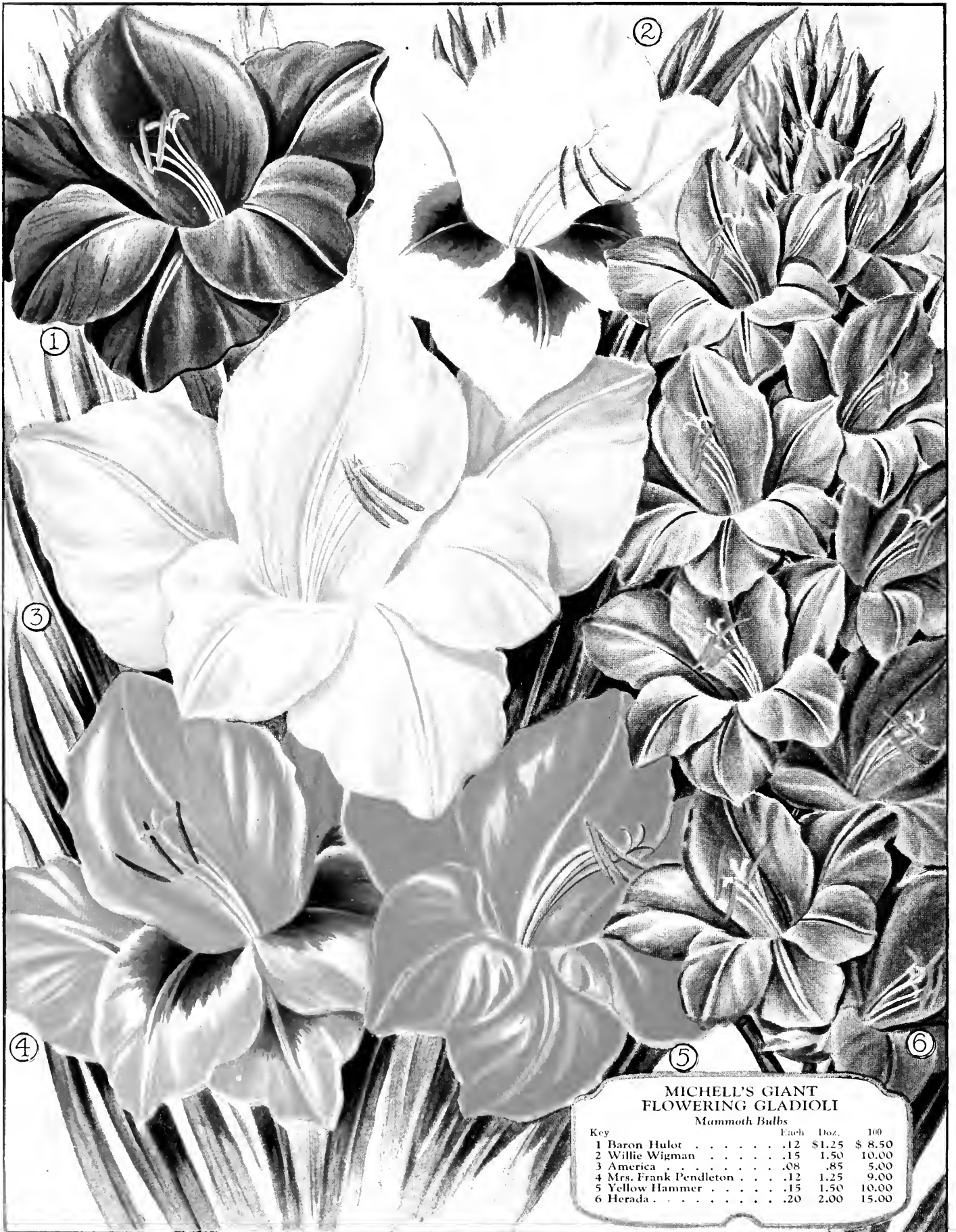

**MICHELL'S GIANT
FLOWERING GLADIOLI**

Mammoth Bulbs

Key	Each	Doz.	100
1 Baron Hulot12	\$1.25	\$ 8.50
2 Willie Wigman15	1.50	10.00
3 America08	.85	5.00
4 Mrs. Frank Pendleton12	1.25	9.00
5 Yellow Hammer15	1.50	10.00
6 Herada20	2.00	15.00

What a wonderful stride the Gladiolus has made during recent years. Its popularity today is exceeded by few other flowers, and it has by no means reached its limit. And there are good reasons for this popularity. Failure with it has never been known. Gladiolus will grow in any open position and bloom well. They are not only showy in the garden, but, when cut with the first flower open will last for 10 days in the house. The newer colorings defy the choicest orchids. Plant bulbs 4 inches deep, 6 inches apart and stake when 2 feet high. Flowers appear from early July until late in the fall.

America. One of the best Gladioli in existence. The color is a beautiful flesh pink, tinged with lavender. The flowers are of the largest size, the petals are round, thick and strong, and will last a long time after being cut. See color plate opposite. 8c. each; doz., 85c.; \$5.00 per 100.

Augusta. Produces graceful, slender stems, which are dressed with beautiful flowers of pure white, slightly tinged and striped pink, which open all at one time. 8c. each; doz., 85c.; \$5.50 per 100.

Baron Hulot. Large flowers, well arranged on long spikes. Color is a deep indigo blue, slightly marked white at the base of the throat. See color plate opposite. 12c. each; doz., \$1.25; \$8.50 per 100.

Bertrex (New). Stands at the top of all existing white varieties; 20c. each; doz., \$2.00; \$14.00 per 100.

Brenchleyensis. One of the best for bedding or planting in front of shrubbery. The flowers are of a vermilion scarlet color. 10c. each; doz., \$1.00; \$5.00 per 100.

Chicago White. One of the leading varieties for cut flower purposes. 10c. each; doz., \$1.00; \$6.00 per 100.

Empress of India. Maroon black; very dark, rich and fine. 12c. each; doz., \$1.25; \$8.50 per 100.

Evelyn Kirtland (New). Flowers of strong substance; color, a beautiful shade of rosy pink, darker at the edges, fading to shell pink at the center, with scarlet blotches on lower petals. 20c. each; doz., \$1.75; \$12.50 per 100.

Glory of Holland. Pure white; fine cut flower. 12c. each; doz., \$1.25; \$7.50 per 100.

Gretchen Zang (New). Large, heavy blooms; a beautiful, soft shade of pink, blending into scarlet on lower petals. 15c. each; doz., \$1.50; \$10.00 per 100.

Halley. Very large, well expanded flowers of a lovely salmon pink; the lower segments are blotched yellow with carmine markings; robust grower. 10c. each; doz., \$1.00; \$6.00 per 100.

Herada (New). Blooms of immense size on tall straight spikes; the color is pure mauve, glistening and clear. See color plate opposite. 20c. each; doz., \$2.00; \$15.00 per 100.

Independence. Rich coral pink, with darker throat. 10c. each; doz., \$1.00; \$5.50 per 100.

Jean Dieulafoy. Flowers creamy white, with maroon colored throat. 20c. each; doz., \$1.75; \$12.00 per 100.

Klondyke. The flowers are of medium size and of great substance; clear primrose yellow with a crimson blotch in the throat. Of dwarf habit. 10c. each; doz., \$1.00; \$7.00 per 100.

Le Marechal Foch. One of the most wonderful novelties; beautiful rose; extra large flowers. 30c. each; doz., \$3.00; \$20.00 per 100.

Lily Lehman. Blush white, tinged with pink. 15c. each; doz., \$1.50; \$11.00 per 100.

Mary Fennel. Beautiful deep lavender on tall slender spikes; lower petals penciled with primrose-yellow. 15c. each; doz., \$1.50; \$11.00 per 100.

Mrs. Francis King. A most beautiful flame pink. Immense flowers on a spike growing 4 feet high, with from 18 to 20 flowers, 6 to 8 being open at one time. 8c. each; doz., 85c.; \$5.00 per 100.

Mrs. Frank Pendleton, Jr. The color is a delicately flushed salmon pink, extending to the reverse side of the petal. The blooms are wide open and are arranged individually on very wiry stems. Each flower is doubly enhanced by a rich maroon blotch on the three lower petals. See color plate opposite. 12c. each; doz., \$1.25; \$9.00 per 100.

Myrtle. A very fine pink, blending into deeper pink. 20c. each; doz., \$2.00; \$12.00 per 100.

Niagara. A shade of rich cream combined with canary yellow; the individual flowers are very large and are borne in pairs, one opposite the other. 12c. each; doz., \$1.25; \$7.50 per 100.

Panama. For form and habit this has all the desirable features of the variety "America," but the wonderful color can best be described with that of the popular rose, "Mrs. Jno Laing," an incomparable rose pink. 12c. each; doz., \$1.00; \$6.50 per 100.

Peace. A grand pure white flower with just a slight marking of a lilac feather on the lower petal. 12c. each; doz., \$1.25; \$7.50 per 100.

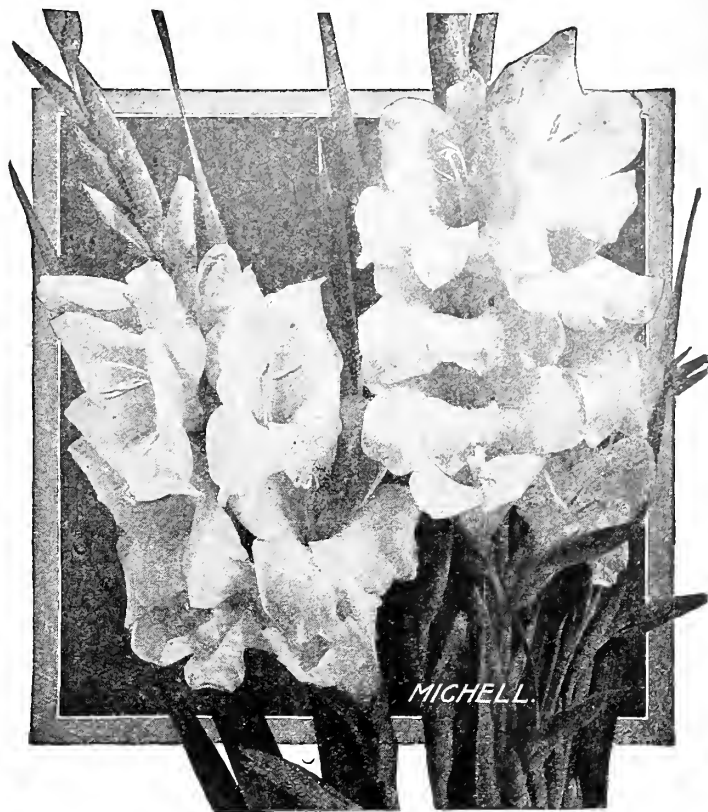

Gladioli America



Gladioli Niagara

MICHELL'S SUPERB GLADIOLI

- Pink Perfection.** Rose pink, with 8 to 10 flowers open at one time. The flowers are well expanded and of perfect form. 15c. each; doz., \$1.50; \$10.00 per 100.
- Prince of Wales.** Beautiful light salmon, with orange shade; very early. 15c. each; doz., \$1.50; \$10.00 per 100.
- Scarsdale.** Long, graceful spikes of wide open flowers, of a pleasing lavender shade; a most unique and distinct color. 12c. each; doz., \$1.25; \$7.00 per 100.
- Schwaben.** One of the newer of the yellow varieties; a magnificent cut flower, because the flowers all open pretty much at one time. 15c. each; doz., \$1.25; \$8.00 per 100.
- War.** This is undoubtedly one of the largest flowered sorts; deep red, shaded crimson and showing 4 to 6 blooms at one time. 15c. each; doz., \$1.25; \$8.50 per 100.
- Wilbrink.** Lovely flesh pink with orange blotch on lower petals. 15c. each; doz., \$1.50; \$8.50 per 100.
- Willie Wigman.** Blush white with dark blotch; extra fine. See color plate opposite page 101. 15c. each; doz., \$1.50; \$10.00 per 100.
- Yellow Hammer.** The best yellow gladiolus. Extra large flowers. See color plate opposite page 101. 15c. each; doz., \$1.50; \$10.00 per 100.

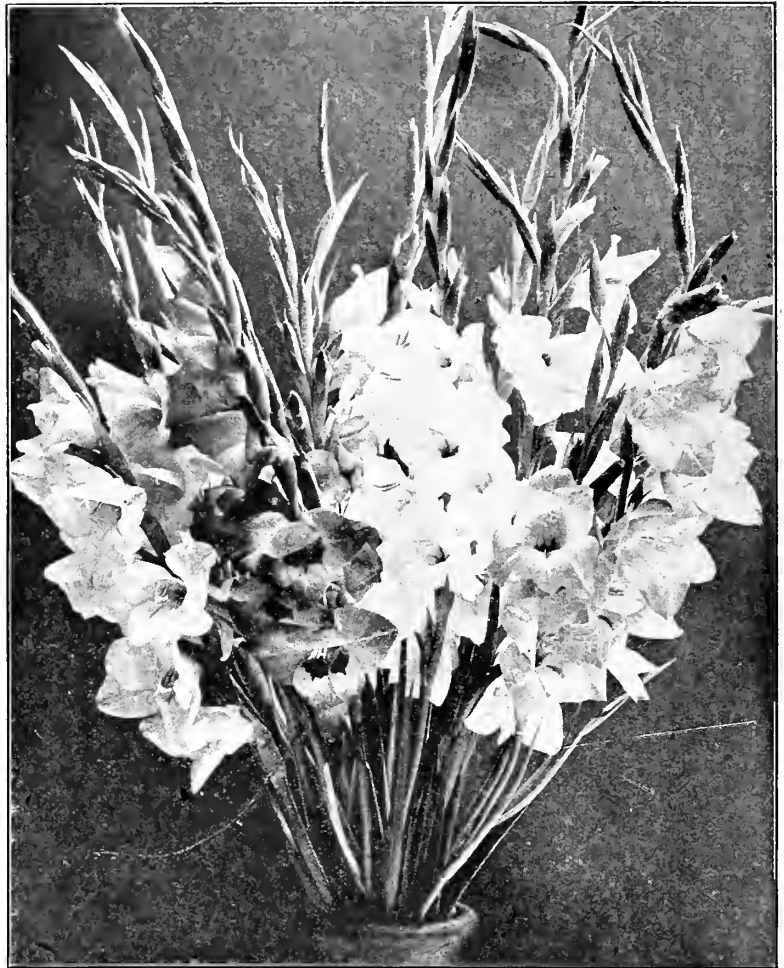

Gladiolus, Primulinus Hybrids

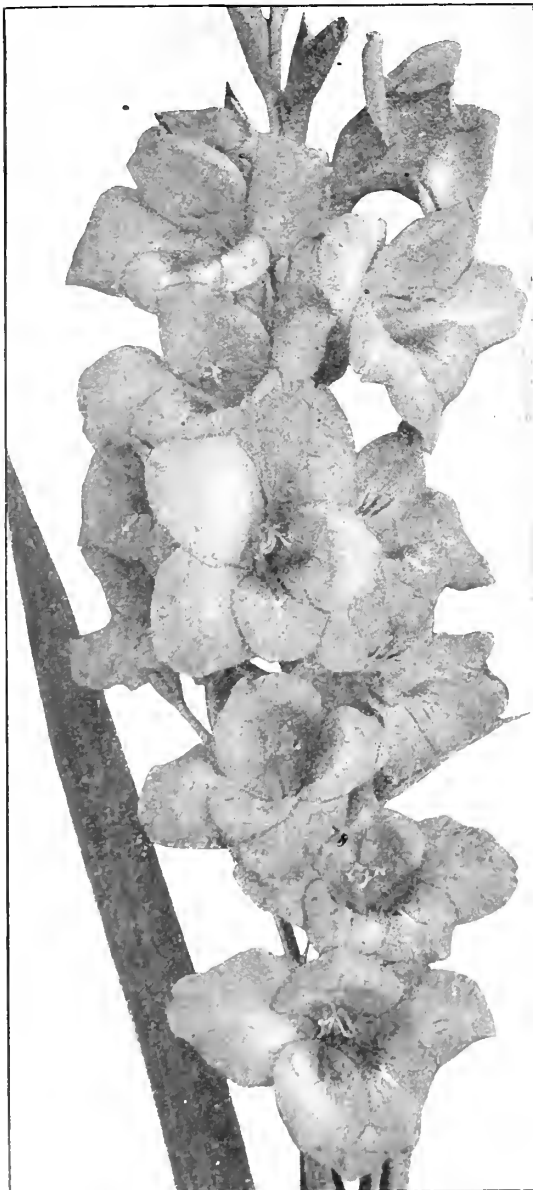

Gladiolus, Empress of India (See page 101)

GLADIOLUS, PRIMULINUS VARIETIES

Flowers of distinct form and possess the clearest tints of color to be found. The spikes are very tall and graceful. Especially for cutting for vases and table decorations, they excel all other Gladioli.

	Each	Doz.	100
Canarybird. Canary yellow	\$0.15	\$1.50	\$10.00
Flamingo. Deep flamingo pink	.15	1.50	10.00
Flora. Light pink, white centre	.15	1.50	10.00
Jewel. Light salmon, with golden yellow blotch	.20	2.00	15.00
Salmon Queen. Beautiful clear salmon	.15	1.50	10.00
Sunray. Golden orange	.15	1.50	10.00

Primulinus Major Hybrids, Mixed. From the purest and lightest of yellow, it varies to the deepest orange, and from the softest shade of salmon pink down to the rich crimson; also a few white. Dainty blotches in the throat add to their beauty. 10c. each; doz., \$1.00; \$5.50 per 100.

UNNAMED GLADIOLI (In Separate Colors)

	Each	Doz.	100
White and Light Shades	\$0.08	\$0.80	\$5.00
Yellow and Orange—All shades	.09	.90	6.00
Red and Scarlet	.08	.80	5.00
Pink and Rose	.08	.80	5.00
Striped and Variegated	.08	.80	5.00

MIXTURES OF GLADIOLI

Michell's Giant Flowering. Every bulb for this mixture has been selected with the utmost care for coloring and size of flower; no other mixture can boast of such careful selection. It is principally grown in our own nursery. 7c. each; per doz., 75c.; \$5.00 per 100.

Extra Choice. All colors mixed. A splendid assortment of first size bulbs, embracing practically all the shades of color in the gladioli family. 6c. each; doz., 60c.; \$3.75 per 100.

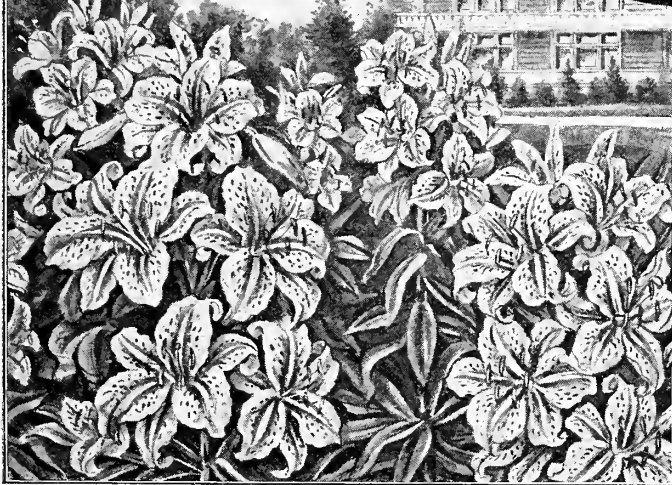

AMERICAN OR NATIVE LILIES

	Each	Doz.	100
Canadense (<i>Canadian Bellflower Lily</i>). Bright yellow bell-shaped flowers, spotted black inside; June and July; 2 feet.....	\$0.20	\$2.00	\$15.00
Canadense Rubrum . Same type as above; crimson with black spots.....	.40	4.00	25.00
Elegans, Leonard Joerg . Rich apricot pink.....	.35	3.50	20.00
Hansoni . Often grows from 3 to 5 feet high; flowers reddish orange, 8 to 12 in a cluster; petals thick and durable.....	.75	7.50	50.00
Henryi (<i>Yellow Speciosum Lily</i>). Tall grower, often 7 feet, producing flowers of a distinct orange yellow in great profusion..	.75	7.50	50.00
Superbum (<i>Turk's Cap Lily</i>). One of the best lilies for all purposes; will grow from 3 to 6 feet high and produce from 15 to 25 nodding brilliant orange red flowers on a single stalk during July.....	.25	2.50	15.00
Tenuifolium (<i>Coral Lily</i>). Brilliant scarlet, bell-shaped flowers, of rather small size, hang downward on a small but gracefully formed tree-like plant; splendid for edges or borders, rockeries or cutting; foliage very slender; flowers in May.....	.35	3.50	25.00

JAPANESE LILIES

Auratum (*Golden Banded*). Enormous, measuring frequently 8 to 12 inches across; pure white, spotted crimson; each petal is marked in the centre with a band of yellow; blooms in August.

	Each	Doz.	100
Large Bulbs, 8 to 9 inch circum.....	\$0.30	\$3.25	\$22.50
Mammoth Bulbs, 9 to 11 inch circum....	.45	4.75	35.00
Monster Bulbs, 11 to 13 inch circum.....	.60	6.50	45.00

Speciosum Album. The best late flowering pure white hardy garden lily; of easy culture. The slender graceful stems and foliage are set off to wonderful advantage by the glistening pure white blooms.

	Each	Doz.	100
Large Bulbs, 8 to 9 inch circum.....	\$0.35	\$3.75	\$25.00
Mammoth Bulbs, 9 to 11 inch circum....	.50	5.25	37.50
Monster Bulbs, 10 to 12 inch circum....	.60	6.50	45.00

Speciosum Magnificum. An enormous flower, rich deep pink spotted crimson, height, 3 feet; flowers in August.

	Each	Doz.	100
Large Bulbs, 8 to 9 inch circum.....	\$0.35	\$3.75	\$25.00
Mammoth Bulbs, 9 to 11 inch circum....	.50	5.25	37.50
Monster Bulbs, 11 to 13 inch circum....	.60	6.50	45.00

Speciosum Rubrum or Roseum. Delicate pink, almost white, spotted red; one of the old garden favorites; very hardy; height, 3 feet; flowers in August and September. Each Doz. 100

	Each	Doz.	100
Large Bulbs, 8 to 9 inch circum.....	\$0.35	\$3.75	\$25.00
Mammoth Bulbs, 9 to 11 inch circum....	.50	5.25	37.50
Monster Bulbs, 11 to 13 inch circum....	.60	6.50	45.00

MISCELLANEOUS JAPANESE LILIES

	Each	Doz.
Batemani . Apricot colored; 3 feet; July.....	\$0.50	\$4.00
Brownii . White inside, outside, brown.....	.75	7.50
Krameri . Blush pink; 3 feet; August.....	.50	4.00
Macranthum (<i>Giant Golden Banded Lily</i>). August..	.60	6.50
Wittei . Very fragrant; white, yellow band.....	1.00	11.00

LILY TIGRINUM

The popular "Tiger Lily," orange, profusely spotted black, very free bloomer, doing well most everywhere.

	Each	Doz.	100
Single Flowering.....	\$0.25	\$2.50	\$18.00
Double Flowering.....	.30	3.00	22.50

LILIAM REGALE (Myriophyllum)

Introduced from China; absolutely hardy, also splendid for forcing; white suffused pink, shaded canary-yellow. \$1.00 each; doz., \$10.00; \$75.00 per 100.

If Bulbs are wanted by Parcel Post, add 10 per cent to value of order to points east of the Mississippi River, and 20 per cent to points west of the Mississippi River.



Amaryllis, Hybrids of Vittata

Cultural Directions for Amaryllis. Place bulbs in live moss, only moderately moist, near window of a warm room. When the first sign of growth appears through the top, pot them up in six inch pots; when the bulb is set, most of it should be above the soil. Water moderately at first, but increase as growth increases, then place in a warm, light room near the window.

If Bulbs are wanted by Parcel Post, add 10 per cent to value of order to points east of the Mississippi River and 20 per cent. to points west of the Mississippi River.

AMARYLLIS

One of the most gorgeous showy house plants, giving splendid satisfaction, not only because of their requiring little care, but also on account of their everlasting nature and tendency to increase.

Belladonna. A beautiful bright pink. 35c. each; doz., \$3.50.

Hybrids of Vittata. The finest race of Amaryllis in cultivation, exceeding in the size and fine form of their flowers as well as in the diversity of colors and markings all former hybrids; flowers striped and flaked. \$1.00 each; per doz., \$11.00.

BEGONIAS (Tuberous Rooted)

Enormous wax-like flowers appear uninterruptedly from June until frost. Plant bulbs outdoors about May 1st or start indoors any time prior to then.

SINGLE BEGONIAS

Each	Doz.	100	Each	Doz.	100
Coppery			Salmon..	\$0.30	\$3.00
Pink..	\$0.30	\$3.00	Scarlet..	.30	3.00
Orange..	.30	3.00	White...	.30	3.00
Pink....	.30	3.00	Yellow..	.30	3.00
Rose....	.30	3.00	Mixed...	.30	3.00

DOUBLE BEGONIAS

Each	Doz.	100	Each	Doz.	100
Crimson..	\$0.35	\$3.50	White...	\$0.35	\$3.50
Pink...	.35	3.50	Yellow..	.35	3.50
Salmon..	.35	3.50	Mixed...	.35	3.50

BEGONIA, CRISPA

The edge of each flower petal is exquisitely frilled.

Each	Doz.	100	Each	Doz.	100
Orange..	\$0.25	\$2.50	White...	\$0.25	\$2.50
Rose...	.25	2.50	Mixed...	.25	2.50
Scarlet..	.25	2.50			

BEGONIA, CRISTATA

Beautifully crested single flowers.

Each	Doz.	100	Each	Doz.	100
Orange..	\$0.25	\$2.50	Scarlet..	\$0.25	\$2.50
Rose...	.25	2.50	Mixed...	.25	2.50



Tuberous Rooted Begonias, Single and Double

6 BULBS OF ANY ONE VARIETY AT DOZEN RATE; 25 AT 100 RATE

(ow)

FANCY LEAVED CALADIUMS

These are grown for us by one of the leading Hybridizers of the world. They are the most charming conservatory plants. Being of a tropical nature, they like a warm temperature. They do quite well outdoors during the summer, if planted in a shaded place. The foliage covers a wide range of colors, making a grand display. The bulbs should be started in moss with plenty of bottom heat.

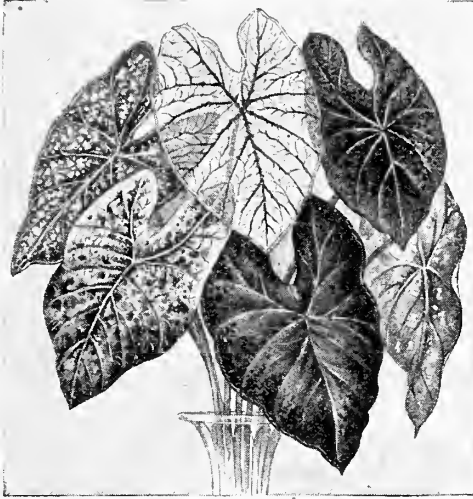

Fancy Leaved Caladiums

Price of Fancy Leaved Caladiums in 12 best named varieties mixed. 30c. each; doz., \$3.00; \$20.00 per 100.

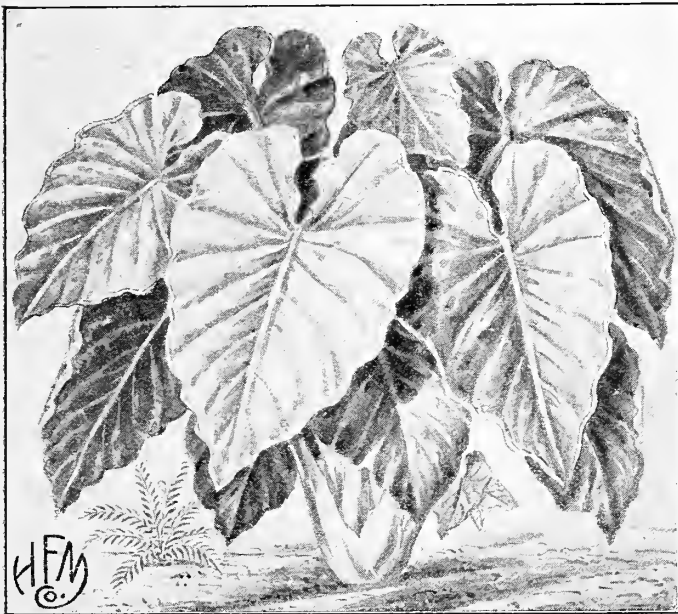

Caladium Esculentum

CALADIUM ESCULENTUM (Elephant's Ear)

As centerpieces in flower beds Caladiums are fine. They make an excellent edging for tall-growing plants. Do not plant outdoors until after May 1st; but to get them in early growth, they may be started indoors.

	Each	Doz.	100
Monster Bulbs, 12-14 in. circum.....	\$0.50	\$5.00	\$30.00
Mammoth Bulbs, 9-11 in. circum.....	.30	3.00	17.50
First Size Bulbs, 7-9 in. circum.....	.20	2.00	10.00
Second Size Bulbs, 5-7 in. circum.....	.10	1.00	6.00

If wanted by mail add 5c. to the price of single bulbs.

CALLAS

Splendid as a pot-plant for the window garden or for growing outdoors, preferring a shaded location. May be started inside any time prior to May 1st, after which they can be safely planted out.

	Each	Doz.	100
Elliottiana. Yellow flower as large as the common white Calla; spotted leaf.....	\$0.35	\$3.75	\$25.00
Spotted. Flowers white; foliage green, spotted white.....	.30	3.25	22.50



Glorinas

GLOXINIAS

A gorgeous plant either for the conservatory or garden. The plants must be well shaded from sunlight and placed in a position free from draught. They should be given but little water until active root growth commences. Bulbs may be started as early as January, but should not be set outdoors until after May 15th.

	Each	Doz.	100
Purple	\$0.35	\$3.75	\$25.00
Red35	3.75	25.00
White35	3.75	25.00
Mixed35	3.75	25.00

MICHELL'S PRACTICAL GARDEN POINTERS

Is the title of a publication we have compiled that contains a mine of information on things horticultural and agricultural. Includes concise cultural instructions on the Canna, Dahlia and Gladioli. There is a free copy for you. Just say, "Send me 'Practical Garden Pointers.'" A post card will do.

TESTIMONIAL ON MICHELL'S BULBS

The bulbs received from you were excellent—could not have asked for anything better. As to your business methods, you are certainly O. K.
C. E. B.

If Bulbs are wanted by Parcel Post, add 10 per cent. to value of order to points east of the Mississippi River, and 20 per cent to points west of the Mississippi River.



Ismene Calathina

ISMENE CALATHINA

(*Pancratium Lilly or Peruvian Daffodil*)

One of the choicest of our summer flowering bulbs, blooming profusely during the summer. Handsome clusters of large, very striking, fragrant pearly white flowers. Bulbs should be kept warm and dry and planted out in the middle of May. They will commence flowering in July. It is really one of the most lovely of all the great Amaryllis tribe. Large bulbs, 25c. each; doz., \$2.50; \$15.00 per 100.

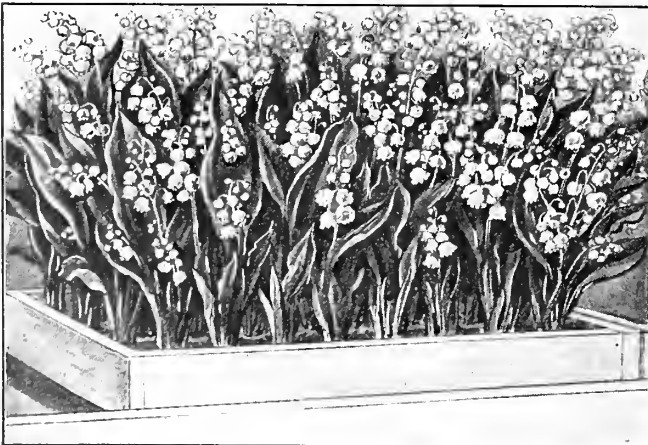

**LILY OF THE VALLEY PIPS
COLD STORAGE**

MICHELL'S GIANT FLOWERING

The finest procurable; can be forced in about 22 days.

Please note that prices vary according to months of delivery.

	Jan. to Mar. Inclusive	Apr. to June Inclusive	July to Sept. Inclusive	Oct. to Dec. Inclusive
Per 100	\$ 6.00	\$ 6.25	\$ 6.50	\$ 6.75
Per 250	11.50	14.75	15.00	15.25
Per 500	28.50	29.00	29.50	30.00
Per 1000	56.00	56.50	57.00	58.00

**LYCORIS SQUAMIGERA (Amaryllis Hallii)
THE MAGIC LILY OF JAPAN**

A perfectly hardy Amaryllis bearing beautiful pink flowers. Produces in early spring attractive green foliage, which grows until July, when it ripens off and disappears, and anyone not familiar with its habits would think the bulb had died, but about a month later, as if by magic, the flower-stalks spring from the ground to a height of two or three feet, developing an umbel of large and beautiful lily-shaped flowers three to four inches across and from eight to twelve in number, of a delicate lilac-pink, shaded with clear blue. Cover the crowns about four inches. For the hardy border or for planting among shrubbery, this is a most excellent subject, and should be more generally grown. Strong-flowering bulbs, 50c. each; \$5.00 per doz.; \$37.50 per 100.

MADEIRA OR MEXICAN VINE

This old favorite, also known as "Climbing Mignonette" is very much prized for porches and arbors, on account of its rapid growth and freedom from insects. Thick, glossy leaves and long, hanging stems of feathery, fragrant white flowers. If roots are protected during the winter, they are hardy. We offer extra large selected tubers. Price, 10c. each; doz., \$1.00; \$7.50 per 100.



Montbretia

MONTBRETIAS

These beautiful late, fall flowering bulbs are very popular for clumping among perennials and shrubbery. Especially effective if planted in masses of from 50 to 100 bulbs in a clump. The flowers resemble a miniature Gladiolus. They should be protected during the winter with leaves or litter. We have succeeded in procuring some new and distinct colorings, as will be seen by the following varieties.

	Each	Doz.	100
Aurantiaca. Deep golden yellow.....	\$0.12	\$1.25	\$8.50
Fire King. Glowing scarlet red.....	.12	1.25	8.50
Geo. Davison. Orange yellow, with stems 3 to 4 feet.....	.12	1.25	8.50
Gerbe d'or. Pure golden yellow.....	.12	1.25	8.50
Germania. Orange scarlet; very beautiful.	.12	1.25	8.50



Summer Hyacinth (*Hyacinthus Candicans*)

SUMMER HYACINTH (*Hyacinthus Candicans*)

In July and August they produce spikes about two feet long, which are covered with bell-shaped white flowers. Large bulbs, 15c. each; doz., \$1.50; \$9.50 per 100.



Tuberoses "Double Pearl"

TUBEROSES

Summer-flowering bulbs, producing long spikes of very fragrant blossoms. Plant out doors after all danger of frost is over. Cover the bulb about one inch with fine light soil. Bulbs planted out about June 1st will bloom in late summer and fall.

Double Pearl. Pure white, first size bulbs, 7c. each; doz., 75c.; \$4.50 per 100.

Double Pearl Mammoth. Extra large selected bulbs. 10c. each; doz., \$1.00; \$7.00 per 100.

Albino. Single white, blooming in July and August. A very free-flowering variety. The odor is less powerful than in the double varieties. 7c. each; doz., 75c.; \$4.50 per 100.

Mexican. The best single Tuberoses, flowering much earlier than all others. Pure white. 7c. each; doz., 75c.; \$4.50 per 100.

ZEPHYRANTHES (Fairy Lily)

Half hardy plants, splendid as pot plants for greenhouse or window-gardens. If planted outdoors in May, they produce flowers during summer and autumn.

Tretea Rosea. The most popular rosy-flowered species. Beautiful clear rose; flowers large and very handsome. 25c. each; doz., \$2.25; \$17.50 per 100.

Tretea Alba. The best white variety, being distinguished from the others by its autumn-blooming habit. If covered in winter with leaves or litter, will live through the winter outside. 15c. each; doz., \$1.50; \$10.00 per 100.



Oxalis Lasiandra

OXALIS (Summer Blooming)

Splendid border plants around flower or foliage plant beds.

Deppii. White, small flowers.

Lasiandra. Rosy pink; beautiful cut foliage.

Shamrock. Clover like foliage; pink flowers.

Either of the above 2c. each; doz., 20c.; \$1.25 per 100.

Testimonial

The bulbs I got from you last year were the finest that I have ever had.

Mrs. W. D. B.

Testimonial

East Greenville, Pa.

I have been selling bulbs for many years, but never before did I handle such fine Tuberoses as received from you.

L. F. P.

PLEASE NOTE.—It is not always convenient for those who like flowers and plants to grow them from seed and cuttings; their wants under such circumstances can be supplied in the form of stock ready grown. Bedding and summer flowering plants are usually ready early in May which is the proper season for planting out, in the latitude of Philadelphia. They are not hardy and must be planted each season. All plants and bulbs are shipped at purchaser's expense unless otherwise specified. **NO PLANTS SHIPPED C. O. D.** Summer flowering plants cannot be mailed, as we send out strong specimens, which travel best by express.

ACHYRANTHES

Excellent for edging beds of various kinds; make a fine show against a green or yellow background; grow about 12 inches high; very compact.

Brilliantissima. Crimson foliage; very bright.

Extra strong plants, 3-inch pots, 25c. each; doz., \$2.00; \$12.00 per 100.

AGERATUM (Floss Flower)

These are one of the freest of flowering annuals and can be adapted to many purposes. As an edging in a garden border few plants surpass it. Flower heads very large. Plants 10 inches high; ideal for massive bedding or edging.

Blue Perfection. 3-inch pot-plants, 25c. each; doz., \$2.00; \$12.00 per 100.

ALTERNANTHERA

Used principally for carpet bedding effects and edgings; fine for working out designs; of very dwarf growth; 4 inches high.

Aurea Nana. Green and yellow, mottled foliage.

Brilliantissima. Red, with a slight trace of green.

3-inch pot-plants, 12c. each; doz., \$1.10; \$7.50 per 100.

ALYSSUM

Little Gem. Pure white flowers; dwarf compact plant; desirable for edging, flowering all season; 6 inches high. 3-inch pot-plants, 12c. each; doz., \$1.10; \$7.00 per 100.

ANTIRRHINUM (Snapdragon)

A very effective plant for massive bedding or border planting, also much used in Italian Gardens. If flowers are cut off after blooming they will continue to flower until frost. In separate colors as follows:

Giant White, Pink, Yellow and Scarlet. Extra strong, 3-inch pot-plants, 30c. each; doz., \$3.00; \$22.00 per 100.

ASPARAGUS

Plumosus Nanus (Asparagus Fern). Highly desirable for fern dishes, bouquet greens, garlands, etc. 3-inch pots, 25c. each; 4-inch pots, 50c. each.

ASPIDISTRA

Lurida. One of the easiest of all decorative plants to grow and one of the very best house plants. It thrives equally well on the porch in summer and in the house during the winter. It is not subject to attack by insects and will do well where any other plant will perish. Strong 6-inch pot-plants, \$2.50 each.

ASTERS (Giant Branching)

We grow a large stock in separate colors; **Pink, Crimson, White and Blue.** Extra strong, 3-inch pot-plants, 12c. each; doz., \$1.10; \$7.00 per 100.

BEGONIAS (Fibrous Rooted)

Erfordi. Of the same habit as Vernon, but having bright pink flowers which almost hide the foliage during the whole summer. 4-inch pot-plants, 30c. each; doz., \$3.00; \$22.00 per 100.

Gracilis Luminosa. A splendid edging variety with bronzy red foliage and brilliant coppery scarlet flowers; very free blooming; of same habit as Vernon. 4-inch pot-plants, 30c. each; doz., \$3.00; \$22.00 per 100.

Vernon. Bright red flowers; compact dwarf plant; one of the best and most effective bedding plants either for edging or massive bedding. 4-inch pot-plants, 30c. each; doz., \$3.00; \$22.00 per 100.

BEGONIA BULBS (Tuberous Rooted)

See Page 104

CALENDULA (Pot Marigold)

These somewhat resemble a double daisy; are fine for cutting, border planting or as a background.

Orange King. Very deep orange.

3-inch pot-plants, 30c. each; doz., \$2.75; \$20.00 per 100.

CANNA ROOTS AND PLANTS

See Page 95

COLEUS

The popular bedding plant so commonly used for edging canna and geranium beds, making an effective show till frost.

Verschaffelti. Dark crimson foliage.

Golden Bedder. Rich canary yellow.

Queen Victoria. Red, with yellow edge.

3-inch pot-plants, 15c. each; doz., \$1.50; \$10.00 per 100.

COSMOS

Michell's Giant Flowering Strain, producing enormous, long-stemmed flowers late in the autumn.

Pink, White, Red, each color separate. 3-inch pot-plants, 15c. each; doz., \$1.50; \$10.00 per 100.

DAHLIA ROOTS AND PLANTS

(See pages 96 to 100.)

DAISY (Bellis Perennis)

These are especially desirable for early spring bedding before it is possible to set out most other plants. Intermingled with Pansies and Forget-Me-Nots (the latter being set out at the same time), they form an attractive combination.

Giant Flowering English, Pink and White, each separate, 20c. each; doz., \$2.00; \$15.00 per 100.

DRACAENA (Fountain Plant)

Indivisa. Attractive; used as a center piece for a round bed, urn or vase and in cemetery work. Strong, 4-inch pot-plants, 50c. each; 5-inch pot-plants, \$1.00 each; 6-inch pot-plants, \$1.50 each.



Nephrolepis. Teddy, Jr.

FERNS

The varieties we offer here are the best of their class and all are good house plants.

Nephrolepis, Scotti. An old favorite; dwarf and bushy.

“ **Teddy, Jr.** A dwarf form of the Roosevelt fern; very bushy.

Nephrolepis, Verona. One of the lace ferns, the best of its type.

Either of above Ferns 4-inch pots, 75c. each; 6-inch pots, \$2.00.

GERANIUMS

Our stock of these is in 4-inch pots, very bushy, well shaped, carefully grown.

Alphonse Ricard. Bright scarlet; double.

Beaute Poitevine. Salmon pink; very double.

Helen Michell. Bright rich scarlet; gigantic flower; to date the very best of its color. 35c. each; doz., \$3.50; \$25.00 per 100.

La Favorite. Double; pure white.

Mrs. E. C. Hill. Soft salmon pink; single flowers.

S. A. Nutt. Rich crimson; double.

Price (except where noted) of any of the above Geraniums, extra fine stock, 4-inch pots, 30c. each; doz., \$3.25; \$22.50 per 100.

GLADIOLUS (See pages 101 and 102)

HELIOTROPE

This plant bears a mass of flowers all summer; the fragrance cannot be approached by any other annual plant.
Centefleur. Large trusses of rich deep violet blue. 4-inch pot-plants, 30c. each; doz., \$3.00; \$22.00 per 100.

HYDRANGEAS (See pages 136 and 138)

LANTANA

Excellent bedding plants, thriving best in the full sun; shades of orange and yellow, so effective in bedding. 4-inch pot-plants, 30c. each; doz., \$3.00; \$22.00 per 100.

LOBELIA

Blue flowering plant, for edging and hanging baskets.
Compacta. For bedding, edging, etc. 3-inch pot-plants, 15c. each; doz., \$1.25; \$9.00 per 100.

LEMON VERBENA

Pointed green lemon-scented foliage; fine for mixing among cut flowers; as a winter house plant these are also very satisfactory. 3-inch pots. 30c. each; doz., \$2.50; \$17.50 per 100.

MARIGOLD

These are favorites in all old-fashioned gardens; in bloom from early summer until frost. Grown from selected seed; flowers grow to enormous size.
Lemon Queen. Orange King.
 20c. each; doz., \$2.00; \$12.00 per 100.

MYOSOTIS (Forget-Me-Not)

Ready after April 10th. Stock usually exhausted May 15th.
Alpestris Victoria. Dwarf blue. 20c. each; doz., \$2.00; \$15.00 per 100.

PALMS

Areca Lutescens. One of the most graceful and beautiful Palms, having bright green foliage with yellow stems. 4-inch pots, 75c. each; 5-inch pots, \$1.50 each.
Kentia Belmoreana. The hardiest Palm in cultivation; of slow growth, and less affected by the dust and dry atmosphere of the house than any other.
Kentia Forsteriana. This splendid variety is very similar to K. Belmoreana, but of stronger growth, with broader, heavier foliage.
 Price for either above Kentias. 3-inch pots, 50c. each; 4-inch pots, \$1.00 each.

PANDANUS

We highly recommend this plant where a good many varieties of other decorative plants will not do. They will thrive even in dark places such as reception halls, living rooms, etc.
Veitchi. Highly colored plants.
 4-inch pots, \$1.00 each; 6-inch pots, \$2.50 each.

PANSIES

MicHELL's Giant Exhibition Strain. It has often been remarked by customers that nowhere else can our Pansies be equaled for size of bloom and rich colors. Fine large plants in bud and bloom in mixed colors only; ready after April 1st. \$1.35 per doz.; 25 for \$2.50; \$10.00 per 100. Stock usually exhausted after May 15th.

PASSIFLORA (Passion Flower)

Pfordti. An attractive climber for outdoor planting in summer, bearing a profusion of light blue flowers suffused with pink. Price, 50c. each.

Williamsport, Pa.

Please send the enclosed list of plants. Those sent in April arrived in fine condition, and are especially satisfactory.
 A. W. G.

PETUNIAS

Of the annual flowers, this is probably the most universally used; it can be put to a variety of uses, for bedding, baskets, window boxes or urns; they flower continuously.
Giant Single Strain. In mixed colors. 3-inch pot-plants, 20c. each; doz., \$2.00; \$12.50 per 100.
Double Petunias. In choice mixed colors. 3-inch pot-plants, 35c. each; doz., \$3.50; \$27.50 per 100.

PHLOX DRUMMONDI

These are a splendid bedding or border plant.
Dwarf. Red, white, pink, each separate. 3-inch pot-plants, 15c. each; doz., \$1.25; \$9.00 per 100.

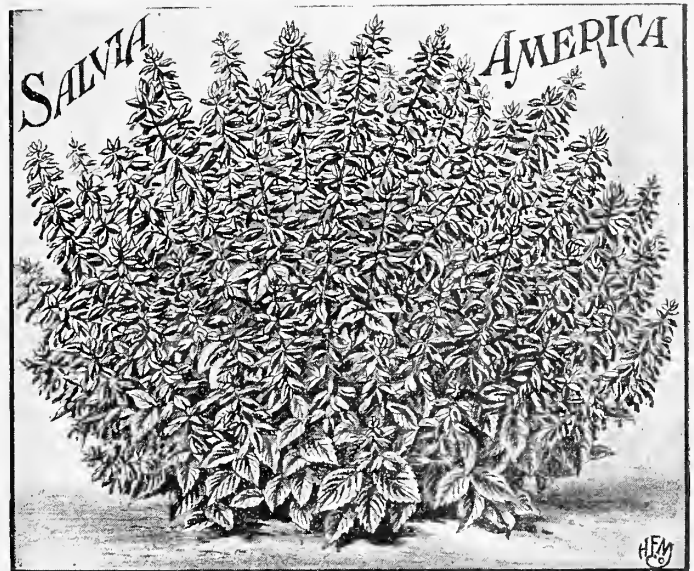

SALVIA (Scarlet Sage)

No show of flowers can equal that produced by Scarlet Sage; it makes a blaze of color when massed or planted in beds that can be recognized at a great distance.
America. Dwarf, bushy and compact.
Bonfire. One of the best dwarf bedding varieties.
 Strong 4-inch pot-plants, 25c. each; doz., \$2.75; \$20.00 per 100.

STOCKS (Gilliflower) 10 Weeks

Sweet-scented flowers, which are fine for cutting, or as a bed or border plant they are splendid.
Double pink, white, blue and red. In separate colors. 4-inch pot-plants, 30c. each; doz., \$3.00; \$20.00 per 100.

VERBENAS

MICHELL'S MAMMOTH FANCY STRAIN

Used for edging borders, or for window boxes and vases.
 In separate colors, pink, white, scarlet, purple. 3-inch pots. 20c. each; doz., \$1.75; \$12.50 per 100.

VINCA

Rosea. This is the flowering type used for bedding or vases; a bed or border planted with these is a beautiful sight; for either full sun or in partial shade they are well adapted. Pink, white, white with pink eye, each color separate. 3-inch pot-plants, 30c. each; doz., \$3.25; \$25.00 per 100.
Major Variegata. A trailing plant used for hanging baskets and window boxes; green foliage mottled white. Extra strong pot-plants, 40c. each; doz., \$4.00; \$30.00 per 100.

ZINNIAS

MicHELL's Giant Robusta Strain. In mixed colors. 3-inch pot-plants, 20c. each; doz., \$2.00; \$12.00 per 100.

MICHELL'S HARDY-POT GROWN ROSES

The Roses we are offering are all strong 2-year old field grown plants that were dug last Fall and potted into 5-inch and 6-inch pots. They were then stored in cold greenhouses where they will start into growth naturally this Spring and by planting time they will be in prime condition. Roses thrive best in an open sunny position and they should be planted away from all trees and shrubs so that the roots will have the full benefit of the nourishment in the soil. Roses are gross feeders and consequently require a rich soil. Select a well drained position where the soil is good and dig in a liberal amount of well decomposed stable manure thoroughly mixing it with the soil. For best results the beds should be made from 4 to 5 feet wide, planting the Hybrid Teas 18 inches apart and the stronger growing Hybrid Perpetuals 2 feet apart, planting all about 8 inches or 10 inches from the edge of the beds. The pot grown plants we send out arrive with a ball of earth around the roots, this ball should not be disturbed but should be thoroughly wet when planted. Budded Roses should be planted so that the bud is about 2 inches below the surface of the ground, firm the soil well around the roots and give a thorough watering. Throughout the Summer, the surface of the bed should be frequently cultivated. The Roses we send out require no further pruning, but are ready to be planted when received; instructions for pruning the following seasons will be found under the heading of the different classes. The best method of protecting Roses for the Winter in this locality is to draw up a mound of soil around the base of the plant to a height of 8 or 10 inches, thereby protecting the buds at the base of the plants from the alternate freezing and thawing, which is so injurious. In addition to this a covering of strawy manure, evergreen boughs or corn stalks is very beneficial. When Roses are growing freely they are less liable to insect pests or fungous diseases than if they are starved or otherwise neglected. A weekly application of Bordeaux Arsenate of Lead Mixture will keep the plants free of almost all insect pests as well as fungous diseases, but if mildew should appear in spite of this periodical spraying use Sulphide of Potassium at the rate of one half ounce to one gallon of water. Green fly or aphid are easily kept in check by tobacco dust or spraying with any nicotine solution.

NEW HARDY HYBRID TEA ROSE—AMERICAN LEGION

Unquestionably the very best hardy Hybrid Tea Rose that has been added to this class in recent years. The name alone warrants it being extensively planted; because we feel only the very best is deserving of the name.

The variety (originated with Mr. Edw. Towill, of Roslyn, Pa.), is a seedling from "MY MARYLAND" on "ORE ENGLISH" crossed with a seedling from "HADLEY" on "MILADY." Any one who is familiar with roses will instantly recognize all of these as strictly high grade sorts; although "AMERICAN LEGION" is in a class entirely its own. The fragrance is somewhat like "AMERICAN BEAUTY," the color is shown on the opposite plate, which has been drawn and colored from nature.

This rose has been in great demand as a cut flower from far and near since it was introduced, and it will be the most popular variety in existence when it can be furnished in quantity. The stems are long, stiff, and clothed with heavy dark green foliage; the blooms when fully opened do not show the centre and are large in size, keeping splendidly when left on the plant, or as a cut flower. Price, \$1.50 each.

PERNET-DUCHER'S NEW YELLOW ROSE (Pernetiana type) SOUVENIR de CLAUDIUS PERNET

This new variety is conceded to be one of Mr. Pernet-Ducher's masterpieces and we give below his own description of this rose:

"A most vigorous grower of erect branching habit, beautiful brilliant green foliage, few thorns, long pointed buds of exquisite shape carried on long stiff stems. Very large full flowers with elongated deep petals, a beautifully formed bloom. Color, most striking sunflower-yellow, deeper in the center, without any color blending, and which is retained without fading even in the warmest weather." Price, \$3.00 each.

SELECT HYBRID TEA ROSES

Under this heading we offer only the best and well tried varieties for outdoor planting and our customers will make no mistake in selecting any of these for their gardens. For best results Hybrid Tea Roses should be severely pruned, the stronger shoots should be cut back to from 8 to 12 inches in height, while all weak thin wood should be removed entirely.

Antoine Rivoire. Rosy flesh on yellow ground, the base of the petals yellow. A delightful combination of color and an ideal bedding variety.

Betty. A superb Rose with blooms of good size, full and globular, with a delightful fragrance. The color is a coppery rose over-spread with golden yellow. An excellent Autumn blooming variety.

Chateau de Clos Vougeot. Velvety scarlet, overlaid with blazing red, changing to deep crimson as the flower expands. A vigorous grower and very free flowering. Price \$1.50 each.

Colleen. Brilliant rose shading from rose-pink to a deeper rose-crimson on a creamy yellow ground; very sweet scented. Price, \$1.50 each.

Columbia. One of the most popular of the newer roses, being a vigorous grower and very free flowering. The flowers are of a pleasing shade of rose-pink, large, fragrant and perfect in form.

Crusader. A big strong growing variety, robust and rugged in every way. The flowers are large, double and in color a rich velvety crimson. A free flowering red rose that is a wonder. Price, \$1.50 each.

Duchess of Wellington. Intense saffron yellow changing to coppery yellow. Flowers large, moderately full of the Killarney type, beautiful buds and delightfully fragrant. A superb yellow rose and a splendid grower, in fact this variety is considered by many growers to be the best of all yellow roses to date.

Edward Mawley. A splendid rose producing freely rich dark velvety crimson flowers which are very fragrant. The growth is strong and the flowers are of a good size. We consider this one of the best red roses to date.

Etoile de France. Another very good red variety succeeding in all parts of the country under many conditions. Color vivid crimson with darker shadings, very double, of good size and deliciously fragrant.

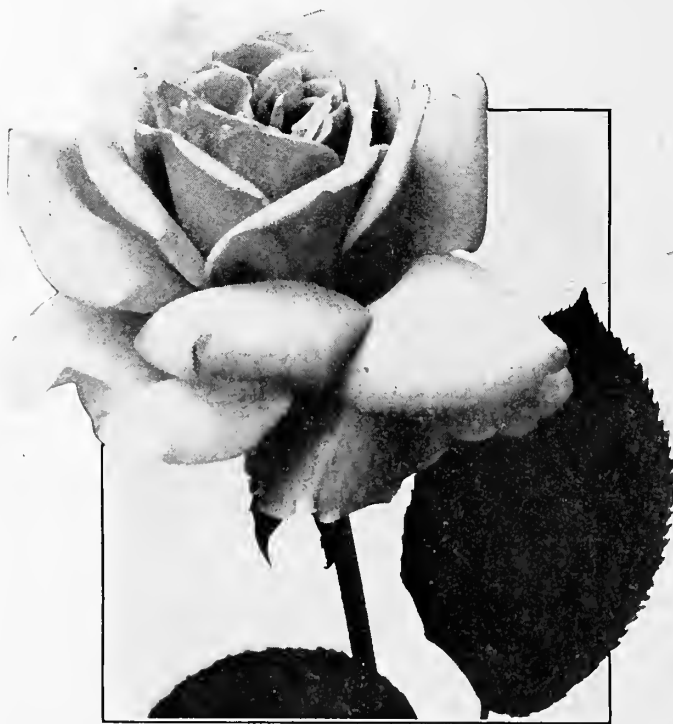

Hybrid Tea Rose, Columbia

Price on any of the above, except when noted, \$1.00 each; per 100, \$90.00 (25 supplied at the hundred rate)
Pot Grown Roses are ready for shipment about May 1

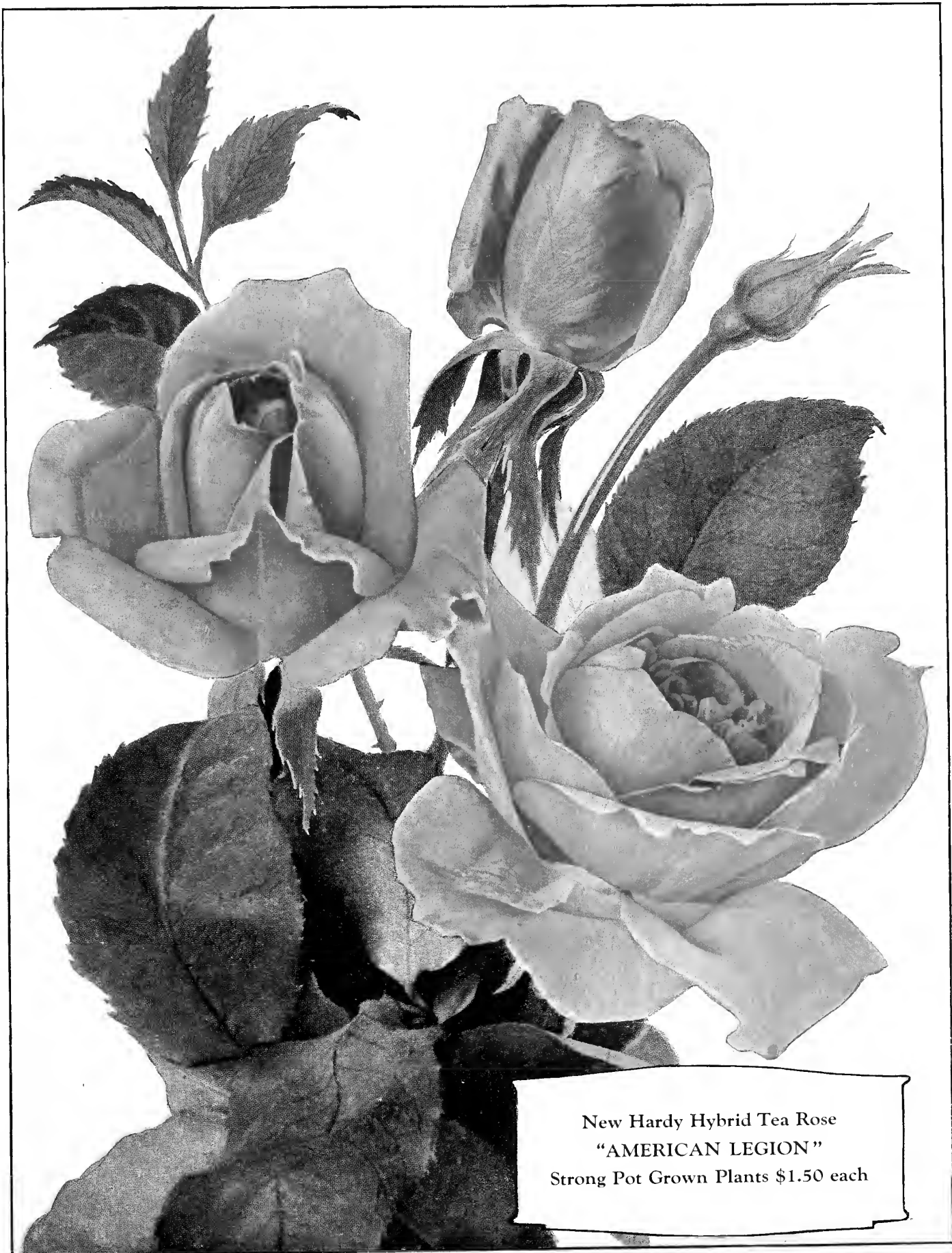

New Hardy Hybrid Tea Rose
"AMERICAN LEGION"
Strong Pot Grown Plants \$1.50 each



OPHELIA

MRS.
AARON WARD

LOS ANGELES

GRUSS
AN TEPLITZ

**MICHELL'S HARDY
HYBRID TEA ROSES**

Extra Strong Pot Grown Plants Each

Gruss an Teplitz	\$1.00
Los Angeles	1.50
Mrs. Aaron Ward	1.00
Ophelia	1.00

SELECT HYBRID TEA ROSES

Francis Scott Key. A glorious rose for the garden. A strong grower, producing large, perfectly formed and fragrant flowers, deep red in color.

George Dickson. Deep velvety crimson, almost black on the face of the petals while the reverse is veined deep crimson-maroon. The blooms are perfect, large, full and fragrant.

Gen. MacArthur. A well known rose, being one of the earliest and most perpetual flowering sorts. The blooms are large, full and delightfully fragrant. In color it is a rich crimson scarlet and the growth is vigorous.

Golden Emblem. One of the most striking of the new roses. It has beautifully formed long buds, deep golden yellow in color and delightfully fragrant. Price, \$1.50 each.

Gruss an Teplitz. This is a rose for everybody, being the most profuse blooming crimson rose in existence. The color is of the richest scarlet, shading to a velvety crimson; very fragrant. It will succeed under the most ordinary conditions, doing well where other roses fail. See color plate opposite page 111.

Hadley. One of the very best garden roses; deep rich velvety crimson in color and one of the most fragrant roses in our collection. Free bloomer with long stiff stems.

Hoosier Beauty. Glowing crimson-scarlet with darker shadings; buds of good length and splendid shape, opening into a magnificent and delightfully fragrant bloom. A strong, clean grower and very free flowering.

Irish Elegance. This is a single rose but the buds are particularly handsome, being long and of a bronzy orange-scarlet.

Jonkheer J. L. Mock. A favorite with hundreds of Rose lovers. The flowers are extra large and of more than ordinary beauty. The bright cherry red on the outside of the broad petals and the shining silvery white on the inside make a double colored bloom.

Kaiserin Augusta Victoria. An old variety but still one of the best and it should be in every collection. In color it is a soft pearly white tinted with lemon.

Killarney. One of the most popular garden roses. The buds are very long and pointed, the blooms are large and of a sparkling brilliant pink, deliciously fragrant. Vigorous grower and a very free bloomer.

Lady Alice Stanley. A rose that is admired by everyone, not only for its freedom of bloom and fragrance, but also for its color, which is a beautiful shade of coral-rose on the outside of the petals with purple flesh on the inside.



Mme. Caroline Testout

La France. One of the first Hybrid Tea Roses to be introduced and still one of the most popular. In color a bright pink on the outside of the petals and a lovely silvery pink on the inside. The growth is vigorous with delightfully fragrant flowers.

Los Angeles. A wonderful American Rose, introduced in 1917 and described by the originators as follows: "Los Angeles is by all odds one of the finest Roses ever introduced. In color a luminous flame pink toned with coral and shaded with translucent gold at the base of the petals. In fragrance it is equal in intensity to the finest Marechal Neil. The buds are long, pointed and extend into a flower of mammoth proportions. The growth is vigorous to a degree. The beauty of the form and ever increasing wealth of color are maintained from the incipient bud until the last petal drops." See color plate opposite page 111. Price, \$1.50 each.

Lyon Rose. Shrimp-pink or coral, center salmon shaded chrome-yellow. Perfect form and fragrance delightful.

Mme. Caroline Testout. One of the most popular and valuable bedding varieties; large globular flowers of bright satiny rose with brighter center. Strong vigorous grower; very free flowering and fragrant, particularly fine in Autumn.

Mme. Edouard Herriot. This is the celebrated "Daily Mail" rose which has been so extensively advertised. In color it is coral red, shaded with yellow and bright rosy scarlet, with yellow at the base; a wonderful combination of most pleasing colors.

Mme. Jules Grolez. A beautiful satiny china rose color, very bright and attractive flowers, very double, of fine form and remarkably free flowering.

Mme. Ravary. Short pointed buds, golden yellow in color, becoming lighter as the flowers open; very fragrant, floriferous and perfectly hardy.

Marquise de Sinety. Buds deep golden yellow, pointed. Open flower cupped with high center, yellow flushed orange and fragrant. Vigorous grower with dark handsome foliage.

Miss Lolita Armour. The unique coloring of this novelty is a combination of tints difficult to describe and is distinct from all other varieties. The flowers are of a large size, full double, with petals of great substance and delightfully fragrant. As the flowers expand they develop to a deep coral-red with a golden coppery red suffusion. The plant is a strong vigorous grower and very free flowering. Price, \$1.50 each.

Mrs. Aaron Ward. A very free blooming variety of vigorous but compact growth. The flowers, which are of splendid form are full double and are equally attractive when in full bloom as in the bud state. The color is a distinct Indian yellow which under certain conditions becomes yellow tinted white. A favorite everywhere. See color plate opposite page 111.



Lady Alice Stanley

Price on any of the above, except when noted, \$1.00 each; per 100, \$90.00 (25 supplied at the hundred rate)
Pot grown Roses are ready for shipment about May 1

25 OR MORE PLANTS WILL BE SUPPLIED AT THE 100 RATE

(ow)

SELECT HYBRID TEA ROSES

Mrs. Arthur Robert Waddell. This is a free flowering rose that should be in every garden. The buds are of the deepest apricot shading to orange-salmon as the flowers open. A vigorous grower and particularly fine in the autumn.

Mrs. Charles Russell. A strong growing variety of branching habit, producing an abundance of beautiful blooms on long stems. The flowers are large, globular, of fine form, in color rosy carmine with rosy scarlet center. A fine variety of American origin.

Mrs. George Sawyer. Brilliant rose-pink; flowers large, full double and well formed. A vigorous grower and free bloomer. Another variety that is extra fine in the autumn.

Muriel Dickson. Of strong, free branching habit, producing its flowers freely, with long pointed buds of a deep reddish copper passing to cherry-red as the flowers open. One of the most distinct.

My Maryland. One of our best bedding roses, holding up well throughout the season and being almost continuously in bloom. In color it is a clear bright salmon-pink. The flowers are double, of perfect form and delightfully fragrant.

Ophelia. This is a variety that has made such a record for itself, that it must be classed among the very best, a rose that is admired by everybody. The flowers held erect on long stems are of perfect form, are of a pleasing shade of light salmon flesh shading to pale yellow at the base of the petals. Blooms profusely all season and far into the Autumn. See color plate opposite page 111.

Premier. A new variety which has proved to be a good forcer and promises to be an equally good bedder. The large full blooms are an exquisite pure rose pink and are borne singly on stiff, almost thornless stems. Very free flowering.

Radiance. A Rose of American origin and to our mind one of the very best varieties in cultivation today. It is an ideal bedder, producing large flowers throughout the Summer when many other varieties are out of bloom; in color a beautiful even shade of pink. This Rose should be in every garden.

Red Radiance. A bright, cheerful and even shade of cerise-red. In size, foliage and growth an exact duplicate of its parent Radiance. A valuable addition to our list of bedding roses.

Richmond. Pure rich scarlet flowers, large and full, very fragrant and free flowering. Particularly good in early summer.

Rose Marie. One of the best bedding roses. A strong grower and exceptionally free flowering. It produces beautiful long buds which open into large flowers of perfect form. A pleasing clear rose-pink in color.

September Morn. A distinct and beautiful rose producing large, delicate flesh-pink flowers on long stems, the petals being undulated or waved on the edges. An exceedingly strong grower.

Souvenir de Claudius Pernet. Described and offered on page 110.

Souv. du President Carnot. Rosy flesh, shaded white; large pointed buds of superb form. Very free flowering, particularly fine in Autumn. This is indeed a splendid Rose and is a great favorite with those who are acquainted with its many excellent points.

Sunburst. A vigorous grower with erect or slightly spreading habit and dark bronzy foliage. The flowers are of medium size, full and of fine elongated cup form; color a superb cadmium-yellow passing to yellow-orange in the center.

White Killarney. A pure white sport of Killarney and equally as beautiful; identical in every way with its parent except in color.

William F. Dreer. A beautiful rose of the same parentage as Los Angeles, which it resembles in the shape of the flowers and in that it is beautiful in all stages of development, but they are at their best when half open. In opening the flowers are of a soft silvery pink with the base of the petals golden yellow, which at certain stages of development gives a golden suffusion to the entire flower, this being particularly brilliant early and late in the season. Price, \$1.50 each.



Hybrid Tea Rose, White Killarney

SELECT TEA ROSES

Tea Roses have always been admired for their delicious fragrance and for their delicacy of coloring. As a class they are not quite as hardy as the Hybrid Teas, but the varieties offered below will winter safely if given ample protection as recommended in our notes on Rose Culture.

Alexander Hill Gray. Deep lemon-yellow, becoming more intense as the bloom expands. Large, full flowers with high pointed center and perfect form; vigorous grower and strongly tea scented.

Harry Kirk. Bright yellow with amber center; long pointed buds with large, fairly double open flowers; vigorous grower, free flowering and very fragrant.

Lady Hillingdon. One of the best Tea Roses of its color, deep apricot yellow throughout. It varies from medium to large size and is very beautiful both in bud and in flower. The plant is hardy, a strong grower and is very floriferous.

Maman Cochet. An extra strong grower, producing its large buds and flowers in the greatest profusion; color deep rose pink, inner side of petals silvery rose, very double; exquisite in bud or when in full bloom.

Molly Sharman Crawford. The flowers on first opening are a creamy white, becoming pure white as they expand. The flowers are large, double and delightfully fragrant. It is a vigorous grower and a free bloomer.

Souv. de Pierre Notting. Large full flowers of apricot-yellow blended with coppery yellow, long buds opening to large full flowers.

White Cochet. Identical with Maman Cochet except in color, which is a pure creamy white with tinting of pink.

William R. Smith. Creamy white with shadings of pink; beautiful in form and color. A vigorous grower and a good bedding rose.

Price on any of the above, except when noted, \$1.00 each; per 100, \$90.00 (25 supplied at the hundred rate)
Pot Grown Roses are ready for shipment about May 1

BABY RAMBLER AND POLYANTHA ROSES

A type of rose which is very popular for bedding purposes. They are mostly dwarf in habit, growing about 18 inches high, producing in great profusion from early in the season until severe frost, immense trusses of small flowers. Pruning is not necessary, simply remove the past season's flower stems.

Anchen Muller. A strong vigorous grower with large clusters of medium double, deep rose-pink flowers from June until autumn.

Cecile Brunner (*The Fairy or Sweetheart Rose*). A Polyantha variety with dainty little double flowers of perfect form produced in many flowered graceful sprays; color a soft rosy pink on a rich creamy white ground.

Clothilde Soupert. A really wonderful rose for bedding; medium size and very double. White shading to deep pink in center and deliciously fragrant. A profuse bloomer and a strong dwarf grower.

Edith Cavell. One of the finest red Polyantha Roses, being a brilliant scarlet with a clear white eye.

Ellen Poulson. A very free flowering dark brilliant pink, very fragrant.

Erna Teschendorff. Beautiful deep crimson; very attractive when planted in masses as it is always in bloom.

Louise Welter. Small cupped blooms of veined rose with feathered edges of soft clear pink. A lovely little Rose.

Mme. Jules Gouchault. Buds bright vermilion-red shaded clear orange-red, flowers of the same color passing to a bright, fiery rose which does not fade. Wood and foliage clear green, producing long panicles of from 25 to 50 perfectly formed flowers of good keeping qualities.

Mme. Norbert Lavvasseur (*Crimson Baby Rambler*). Similar in color to the climbing Crimson Rambler. One of the most popular.

Mrs. Cutbush. Blooms of medium size, of a pleasing shade of peach-pink, and are produced freely in large clusters until late in the Autumn. The plants are hardy, strong and vigorous.

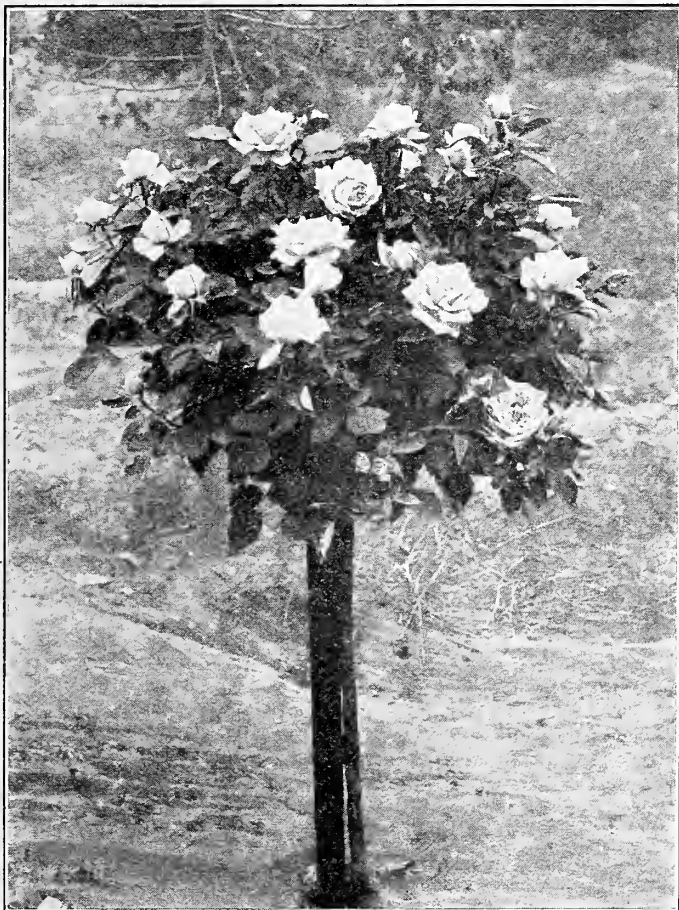

Standard or Tree Rose

Orleans. An ideal rose for bedding, flowers of large size and of a brilliant geranium red, becoming suffused with rose as the flowers mature, and with large white centers. A very pretty combination.

Yvonne Rabier. A fine white variety, with full double flowers; perfect habit and an excellent sort for massing.

Price of any of the Baby Rambler and Polyantha Roses, 75c. each; per 100, \$60.00.

STANDARD OR TREE ROSES

We offer a splendid collection of specimen standard tree roses grown on sturdy hardy stems about 4 feet high. They are wonderfully effective for planting in the rose garden, as they relieve the flat appearance of all bush roses together and give the flowers a certain individuality. It is necessary to give standard roses some support and a stout stake should be driven down beside the plant and the stem securely fastened to the stake. These roses should have all thin or weak growth removed early in Spring before any growth starts and the stronger shoots should be cut back to 8 to 12 inches in length according to requirements in retaining the shape of the head.

Frau Karl Druschki. Very large, double pure white flowers; the ideal white Rose.

Gross an Teplitz. The most profuse blooming crimson rose in existence, producing fragrant flowers of the richest scarlet.

Lady Alice Stanley. A rose admired by everybody, not only for its freedom of bloom and fragrance but also for its color, which is a beautiful shade of coral rose.

Lady Ashtown. One of the freest flowering varieties in our collection, producing large, full double flowers of a soft rose color, shading to yellow at the base of the petals.

Los Angeles. A wonderful American rose, of a luminous flame pink toned with coral and shaded with translucent gold at the base of the petals. Very fragrant.

Mme. Caroline Testout. One of the most popular varieties; large globular flowers of bright satiny rose with brighter center.

Mme. Edouard Herriot. A beautiful coral-red, shaded with yellow and bright rosy-scarlet, with yellow at the base; a wonderful combination of pleasing colors.

Mme. Jules Bouche. Handsome white flowers with center shaded primrose or faintest blush; fragrant. Considered one of the best of its color.

Magna Charta. An old variety of great merit. The blooms are large, bright pink suffused with carmine; fragrant; free flowering.

Mrs. Aaron Ward. A very free flowering variety, producing full double flowers of Indian yellow, which under certain conditions becomes tinted with white.

Ophelia. This is a rose that is admired by everybody. The flowers are of a pleasing shade of light salmon flesh shading to pale yellow at the base of the petals.

Rosarie. An improved Tausendschoen, of the same habit of growth, but superior in color, a deeper and more even shade of cerise pink; free bloomer.

Price, any of the above Standard or Tree Roses, \$3.00 each.

BABY TREE ROSES

These differ only from the regular standard Roses in the length of stem. The stems of these being only 2 feet high, compared with 4 feet of the regular standard. Very useful for planting in many places where the regular standard is too high. We offer only two varieties, both of which are of the baby rambler type.

Greta Kluis. A pretty shade of deep carmine pink, shading to red; very free flowering.

Orleans. Flowers of a large size and of a brilliant geranium red, becoming suffused with rose as the flowers mature and with large white centers. A very pleasing combination and almost continually in bloom.

Price of any of the above, \$3.00 each.

PERMANENT METAL LABEL



For marking trees, shrubbery, perennials, roses, etc. Made of zinc with eyelets for attaching wires for securing to plants. In

furnishing labels, we undertake to put the name of variety only on same, not species. For instance, in the case of Rose, La France we would furnish label embossed La France. In ordering allow one week for the execution of order. Write list plainly. Not less than 25 labels can be supplied. Price, 5c. per label (irrespective of the quantity wanted), wired ready to attach to plant, bush or tree. One or as many of a variety as may be desired can be supplied.

HARDY HYBRID PERPETUAL ROSES

Before the development of the Hybrid Teas, this was the most popular type for garden planting and even now they should not be overlooked, but should be used extensively in conjunction with the other sorts. They are perfectly hardy and of vigorous growth, they bloom tremendously in June and sometimes sparingly in Autumn. Hybrid Perpetuals are taller in growth and need more space than the Hybrid Teas; in pruning cut away all weak growth, and if quality of bloom is desired, cut back the strong canes to within 8 or 9 inches of the ground, but if quantity of bloom for garden effect is desired, leave these canes from 2 to 3 feet high, according to their strength.

American Beauty. Very large flowers, deep pink to carmine-erise delicately veined with darker red. A strong grower and deliciously fragrant.

Baron de Bonstetten. Dark velvety crimson; very large, double fragrant flowers. A strong grower.

Frau Karl Druschki. This is the queen of all white roses both in size and purity. The flower is very double and opens to a pure snow white. The growth is vigorous and the plant is a most prolific bloomer during the month of June. Scattering flowers often appear in the Fall, although Hybrid Perpetuals seldom flower again the same season after producing their main crop in June.

Gen. Jacqueminot. The old favorite "Jack" rose is still popular. The blooms are large, full and globular, having an excellent cup shaped form; in color they are brilliant scarlet crimson, with deep veining toward the base of the petals.

George Arends. A strong grower bearing an abundance of beautiful pink flowers. One of the best of this type of roses.

Gloire Lyonnaise. Very large full flowers, white tinted with yellow; very free, distinct and pleasing.

Magna Charta. An old variety of great merit. The blooms are of a large size, in color a bright pink suffused with carmine. It is very fragrant and free flowering.

Mrs. John Laing. Beautifully formed shell-pink flowers; exceedingly fragrant and borne on strong stems; splendid for cutting. A good grower and one of the most popular roses.

Paul Neyron. Probably the largest rose in cultivation, in color a clear pink shading to soft rose and having a delightful fragrance. A strong vigorous grower and like Frau Karl Druschki will often produce scattering flowers during the late Summer and Fall.

Prince Camille de Rohan. Deep velvety crimson passing to intense maroon; large, handsome fragrant flowers.

Ulrich Brunner. Extra large flowers of a bright cherry red. A good strong grower and a free bloomer; a variety that always does well.

Price, any of the above, \$1.00 each; \$90.00 per 100.

MOSS ROSES

The beauty of the Moss Rose consists in the delicate mossy covering which surrounds the buds, and gives the opening flowers a unique appearance. They bloom profusely in June. Moss Roses should be pruned sparingly; cut the old wood and shorten back the growth of last year.

Blanche Moreau. Large, pure snow white flowers produced in clusters. Both buds and flowers have deep green moss.

Crested Moss. A delightfully fragrant sort of pale rosy pink, crested with rich green shadowy moss.

Henry Martin. Large crimson flowers, very fragrant; both bud and flower heavily mossed with deep green.

Princess Adelaide. Bright silvery rose. A very fine sort.

Price, \$1.00 each; per 100, \$90.00.

RUGOSA ROSES

These Roses are absolutely hardy and vigorous growers. They grow from 4 to 6 feet in height and may be used for hedges or as specimens in the shrubbery border.

Rugosa. In flower nearly the whole summer, producing single fragrant flowers, rosy carmine in color, followed during the autumn and winter by brilliant scarlet seed pods. Price, 75c. each; per 100, \$60.00.

Rugosa Alba. Identical with the above excepting in the color of the flowers which is pure white. Price, 75c. each; per 100, \$60.00.

Conrad Ferdinand Meyer (Double Rugosa). Pure silvery pink, surpassing all others of the Rugosa family in beauty of color and fullness of form; fragrant and hardy; handsome in foliage and valuable as an ornamental shrub. Price, \$1.00 each.



Hybrid Perpetual Rose, Frau Karl Druschki

MISCELLANEOUS ROSES

Austrian Copper (Austrian Brier). The medium sized flowers are single and of a lovely bright coppery red. This type of rose is very hardy but flowers only in Spring; they should be pruned sparingly, merely cut out the old wood and shorten back the growth of last year. Price, 75c. each.

Gardenia (Wichuriana). Buds bright yellow opening into creamy white flowers, resembling in form and color a Gardenia. Price, 75c. each; per 100, \$60.00.

Hermosa (Bourbon). This is one of the old fashioned roses and still a great favorite. It is a dwarf compact growing variety, producing masses of bright pink flowers during the season. Excellent for cemetery planting. Price, 75c. each; per 100, \$60.00.

Hugonis (Rosa Hugonis). This is a natural species and is most suitable for planting in the shrubbery border. It grows about 6 feet high and the same in diameter when fully matured, every branch being loaded with pretty single yellow flowers early in Spring; perfectly hardy and disease resisting. Price, \$1.50 each.

Juliet (Pernetiana). The outside of the petals is old gold, and the inside varies from scarlet to rosy red. It is particularly beautiful in the bud and half open stages; deliciously fragrant. Price, 75c. each.

Soleil D'Or (Pernetiana). A vigorous growing variety with large, full flowers of golden yellow shaded Nasturtium-red. Price, 75c. each.

Wichuriana. Of Japanese origin and flowering during June and July; of a trailing habit of growth, very hardy and suitable for covering graves, climbing over walls, arbors, stumps of trees, rocks or rough ground. The foliage is of a leathery texture of a beautiful shining green and not only proof against insects but remains on the plant until late in the Winter, making them almost evergreen. The flowers are fragrant, single, pure white with yellow stamens followed in the Fall with bright red hips or berries. Price, 75c. each; \$60.00 per 100.

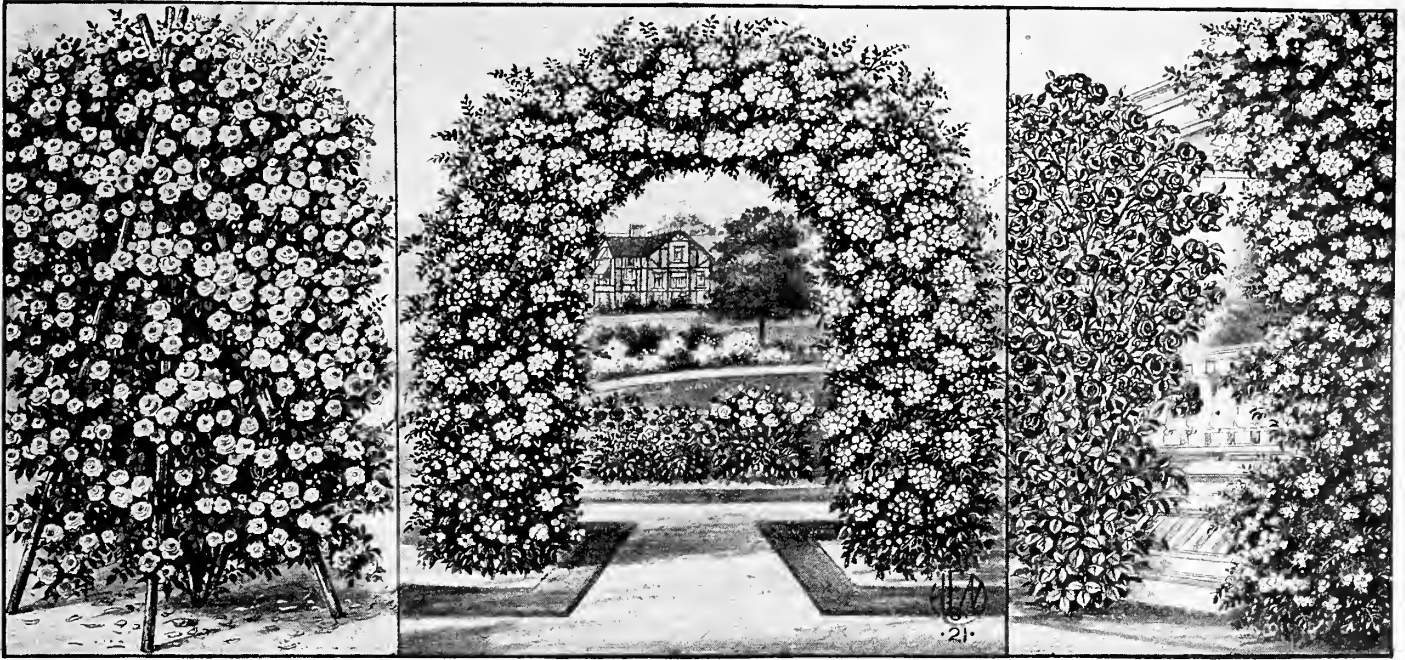

HARDY CLIMBING AND RAMBLER ROSES

As an ornamental plant for covering verandas, porches, side walls, pillars, fences, etc., these are unequalled, calling forth more admiration than anything else that can be used. They require no pruning in the Spring beyond the cutting out of very old or dead wood and shortening of the laterals and long canes to make the growth conform to the space to be covered, but a severe pruning in July directly after they have finished flowering is beneficial. Cutting away at that time all old flowering wood will encourage a vigorous growth, which will give an abundance of flowers the following season.

American Pillar. The large single flowers are a lovely shade of cherry pink, with a clear white eye surrounding numerous golden yellow stamens. The canes are of a strong vigorous growth and flower freely. The foliage is distinct and decorative.

Aviateur Bleriot (The New Yellow Rambler). A strong growing plant with beautiful glossy insect and disease proof foliage, bearing large clusters of medium full sized double flowers of a saffron yellow dispersing to an almost golden yellow in the center.

Christine Wright. A beautiful rose of strong climbing habit, producing double flowers 3 to 4 inches in diameter, singly and in clusters, of a wild rose pink.

Climbing American Beauty. The name of this rose is rather misleading, yet on its own merits it is a splendid climber. It has but one blooming season, June, when it bears very abundantly a very bright self colored, medium pink flower of moderate size. It has splendid glossy foliage, each flower opens full and perfectly, comes on a nice long stem for cutting and would be a credit to a bush grown rose.

Dr. W. Van Fleet. One of the most important climbing roses, having perfectly formed buds, long and pointed, deep pink in color and very solid. The full blown flowers are very large, borne on long stems, fragrant and fine for cutting.

Dorothy Perkins. Beautiful shell pink, fragrant and full, blooming in clusters in June. The most popular of all climbing roses during the past few years. This is a very good rose for covering stone walls, fences, embankments and arbors.

Excelsa. Here we have a worthy successor to Crimson Rambler, being equally as free flowering as that variety but without its unsatisfactory foliage, this variety being a true Wichuriana rambler with all of the strong wiry growth and beautiful foliage of this desirable class. Really the best double red rambler.

Hiawatha. The most brilliant climbing rose, in color a brilliant ruby carmine with a clear white eye and a mass of golden stamens. The foliage is light glossy green, making this an exceptionally beautiful climber.

Pauls Scarlet Climber. No other rose in any class can compare with it for brilliancy of color, which is a vivid scarlet that is maintained without burning or bleaching until the petals fall. The flowers are of medium size, semi-double, very freely produced in clusters of from three to six flowers each on much branched canes, the plants being literally covered with flowers from top to bottom. It is of strong climbing habit and perfectly hardy.

Silver Moon. An indispensable hardy climber having long well shaped buds, creamy yellow on first appearance, opening into immense Clematis like flowers of a waxy whiteness. The center is a mass of bright yellow stamens making a wonderful contrast.

Tausendschoen. The individual flowers are of a most elegant and graceful form. In color it is a most delicate shade of soft pink when first opening, changing to carmine on the reverse of the petals when fully expanded. The flowers are produced in trusses, each truss almost a bouquet in itself.

White Dorothy. A handsome pure white sport from the old favorite Dorothy Perkins, and it has all of the finer qualities found in that charming variety.

Price. Strong plants of any of the above, 75c. each; \$60.00 per 100.

CLIMBING HYBRID TEA ROSES

These are not quite as free flowering as the bush type of Hybrid Tea Roses, but they produce a large crop of beautiful flowers in June with quite a liberal scattering of flowers throughout the season. In pruning these cut out all small thin wood and cut the strong shoots back to prominent eyes.

Climbing Mme. Caroline Testout. Beautiful glowing pink, identical in flower with its parent namesake; a rampant climber.

Climbing Sunburst. A true Sunburst of vigorous climbing habit.

Climbing Hoosier Beauty. A climbing form of this beautiful Rose. Brilliant crimson scarlet flowers of exquisite form; long buds and very fragrant.

Climbing Kaiserin Augusta Victoria. Ivory white, identical with the parent K. A. Victoria, except in its strong climbing habit.

Climbing Lady Ashtown. The best of all climbing H. T. varieties; a wonderful grower, producing throughout the entire season, numerous soft rose colored flowers, fine for cutting.

Price of any of the above, \$1.00 each; per 100, \$90.00.

Tender Climbing Rose, Marechal Neil. The most beautiful of all Yellow Roses in the South where it is hardy—unfortunately it is not hardy north of Washington. A climbing variety with bright green foliage and large, full flowers of deep rich yellow, particularly fine in bud form. Price, \$1.00 each.



Year by year these old fashioned hardy flowers are gaining favor and deservedly so, as there is not a time during the whole flowering season when some variety is not in bloom; they are especially valuable during the late Summer and Autumn, when there are but few shrubs in bloom. From early April they continue with constant changing variety throughout the Summer and Fall, when they are stopped only by severe freezing weather. Hardy Perennials appear year after year, and as each variety has a fixed time for blooming, a selection can be made that will give flowers to cut from early Spring until late Fall. The most satisfactory arrangement is to plant them in a border, which can be made in front of a hedge, fence or wall, or in the open garden; the soil should be dug to a depth of 18 inches or two feet, pulverizing it thoroughly and working in a liberal quantity of well decomposed stable manure or other fertilizer. The plants should be placed in groups of three or more of one variety together, the taller growing sorts at the back, the medium heights in the center and the dwarf varieties in front; they should also be placed so as to have some flowers in all parts of the border at all times. This can be easily arranged by referring to our descriptions as to the time of flowering. Our book on "Hardy Perennials" is an instructive publication, and it can be had free on request.

All plants are forwarded on receipt of order unless instructed to the contrary, and are sent by Express, purchaser paying charges. We can forward small plants or small numbers of plants by Parcel Post, and if wanted sent in this way add 10 per cent. to value of order for postage to points east of the Mississippi River, and 20 per cent. to points west of the Mississippi River.

SPECIAL NOTICE ON GUARANTEE

We spare no effort to supply plants of the best quality in first-class living condition. On account of the many causes beyond our control we regret we cannot guarantee this stock to live and establish itself, as that is usually entirely within the power of the buyer or planter. If customers desire us to guarantee plants and shrubs to live we will assume such guarantee at an advance of 25 per cent. over and above our usual prices, but not otherwise, and such guarantee will expire within 90 days from date of shipment.

ACANTHUS (Bear's Breech)

Mollis Latifolius. A handsome decorative plant of stately effect, with deeply-toothed, heart-shaped leaves, 2 feet long; excellent either for planting as single specimens on the lawn or in the border, or for grouping with other plants for sub-tropical effect, producing 3-foot high spikes of curious rose-colored flowers during August and September. 35c. each; doz., \$3.50.

ACONITUM (Monkshood or Helmet Flower)

All these varieties form bushy clumps; invaluable for planting under trees or in shady or semi-shady positions.

Napellus. Large, dark blue flowers; 3 feet; August to September.

Fischeri. A dwarf variety growing 18 inches high, with large, pale blue flowers in September and October.

Sparks' Variety. The darkest blue of all; flowers in June; 3 feet.

Price, 35c. each; doz., \$3.50; \$25.00 per 100.

ACHILLEA (Milfoil or Yarrow)

Eupatorium (Fern-leaved Yarrow). Finely-cut foliage and brilliant yellow heads of flowers, lasting in full beauty all summer; 4 to 5 feet.

Millefolium Cerise Queen (Rosy Milfoil). Finely cut, deep green foliage; flowers cherry red in dense heads; 18 inches high.

Ptarmica Fl. Pl. "The Pearl." Pure white flowers borne in the greatest profusion the entire summer on strong, erect stems, 2 feet high; as a summer cut flower it is of great value.

Ptarmica Boule de Neige (Ball of Snow). An improvement on The Pearl; the flowers, while not quite so large, are of more perfect form, with fuller centres, which makes it appear purer in color.

Price, 30c. each; doz., \$2.50; \$18.00 per 100.

AGROSTEMMA (Rose Campion)

Stout, erect-growing plants, with silvery foliage, which contrasts well with the showy flowers, which are produced during June and July.

Coronaria (Mullein Pink). Bright rosy crimson; 2½ to 3 feet.

Coronaria Alba. A pure white variety.

Flos Jovis. Deep pink.

30c. each; doz., \$2.50; \$15.00 per 100.

ALYSSUM

Saxatile Compactum. An excellent low spreading plant for rockery or border, growing about 10 inches high and producing in May masses of golden yellow flowers. 30c. each; doz., \$2.50; \$18.00 per 100.

AMSONIA

Salicifolius. A stout, shrub-like plant, growing about 2 feet high, with terminal spikes of light steel-blue flowers; desirable to intersperse in clumps in the front row of the shrubbery border. 35c. each; doz., \$3.50.

ANCHUSA (Sea Bugloss)

Italica. "Dropmore Variety." Plants grow 4 feet high in pyramidal shape, branch freely and are loaded with bright blue, Forget-me-not-like flowers in June; very showy and valuable. 30c. each; doz., \$3.00; \$17.50 per 100.

Opal. Pale blue, very large flowers. 35c. each; doz., \$3.50; \$20.00 per 100.

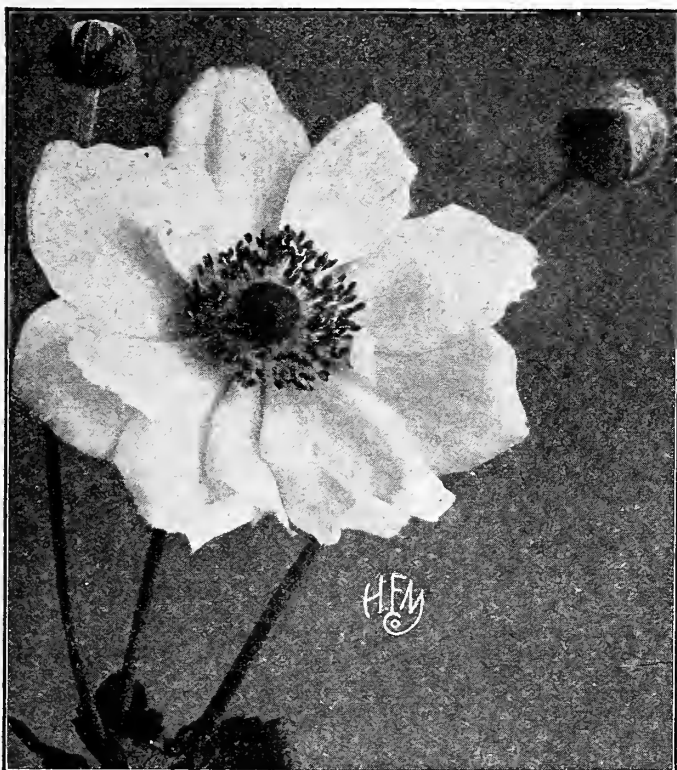

Anemone—Japonica

ANEMONE JAPONICA (Windflower)

As a last greeting of autumn these gay flowers appear in wondrous brilliancy and produce a wealth of bloom just before nature clothes the earth with a mantle of frost.

Plants vary from 2 to 3 feet high, and are ideal for cutting; the flowers appear in August and remain till frost. They require winter protection with leaves, straw or long manure, which amply repays one for the extra trouble taken.

Japonica Alba. Large, snowy-white; very chaste.

Japonica Rubra. Beautiful rosy-red; stamens bright yellow.

Queen Charlotte. Very large semi-double flowers of La France pink, a color that is rare among hardy plants.

Whirlwind. Large, semi-double pure white flowers, very free.

Price. Any of the above, 30c. each; per doz., \$2.50; \$18.00 per 100.

NEW ANEMONE

Hupehensis. A new species from Central China, resembling *Anemone Japonica* in growth, but not quite so tall. Delicate mauve flowers appear in August, continuing until late Fall. 30c. each; per doz., \$2.50; \$18.00 per 100.

ANTHEMIS (Marguerite)

Tinctoria. This hardy Marguerite is one of the most satisfactory summer-flowering perennials, succeeding in the poorest soil; of bushy habit, growing about 15 inches high, and producing its large golden-yellow daisy-like flowers continuously during the entire summer. 30c. each; doz., \$2.50; \$15.00 per 100.



Aquilegia (Columbine)

AQUILEGIA (Columbine)

For spring blooming these are invaluable, producing their graceful spurred flowers on stems rising 2 feet over their attractive foliage, during May and June. For rockery gardens, semi-shaded places, in hardy borders or planted in clumps, they are very effective.

Michell's Long-spurred Hybrids. This is the most admired type of Columbines. They have been produced from the strains of several famous hybridizers and are much superior to the usual grade. The plants are of strong, thrifty growth. The flowers of largest size vary in color through charming tones of cream, pink, lavender, blue, white, red, etc., hardly any two being exactly alike. We offer them in mixed colors only.

Canadensis (Common American Columbine). The native bright red and yellow variety, and one of the brightest.

Chrysantha (Golden Columbine). Bright yellow, long-spurred flowers.

Coerulea (Rocky Mountain Columbine). Bright blue and white long-spurred flowers.

Flabellata Nana Alba. A dwarf growing, pure white variety.

Helena. Large blue flowers with white corolla.

Rose Queen. A newer variety of a pleasing shade of delicate pink, long-spurred flowers.

Vulgaris (Common European Columbine). Violet blue.

Price of all Aquilegias. 30c. each; doz., \$2.50; \$18.00 per 100.

ARABIS (Rock Cress)

Alpina. One of the most desirable of the very early spring-flowering plants that is especially adapted for edging and for the rock garden, but does equally well in the border, forming a dense carpet, completely covered with pure white flowers. Lasts for a long time in bloom. 30c. each; \$2.50 per doz.; per 100, \$15.00.

MICHELL'S HARDY PERENNIAL PLANTS

HARDY ASTERS

Tall-flowering, stately plants, which may be used with splendid effect in borders or in clumps as specimens on lawns, in large groups or beds. They form the basis of a color scheme in a perennial border during the months of September and October, and last well into November. The rich shades of blue and purple blend harmoniously with most any surrounding. They thrive equally well in the sun or partial shade. For cutting they are invaluable. The wide range of color makes this one of our finest summer and autumn-flowering perennials.

FALL FLOWERING VARIETIES

Autumn Beauty. An exquisite shade of light blue; very large flowers, commencing to bloom in the late summer and continuing almost up to frost time; height, about 4 feet.

Feltham Blue. One of the most decorative free-flowering varieties; color, a pretty shade of aniline blue; August and September; 2½ feet high.

Glory of Colwall. A splendid improvement on the variety Beauty of Colwall, with good-sized, nearly double, ageratumb-like flowers; remarkably free flowering; 2½ feet, September and October.

Mrs. F. J. Raynor. Delicate lavender.

Novae Angliae. Varying shades of rich violet-purple; 4 feet.

Roseum Superbum. This is one of the best hardy Asters we have ever seen. The color is almost red and it is a most profuse bloomer.

Novi Belgii Climax. Of strong, vigorous habit, 5 feet high; branched pyramidal-shaped flower stems; lavender-blue flowers. August-October.

Novi-Belgii, The Queen. A splendid variety; blush white; 4 to 5 ft. high.

Robert Parker. Pale heliotrope; height 4 ft.

Snowflake. Very free bloomer; pure white; height, 2 feet.

St. Egwin. Densely branched, producing beautiful pink flowers; 3 feet; September.

Tataricus. Large bluish lilac, 6 feet.

Price, any of the above, 30c. each; doz., \$2.50; \$18.00 per 100.



Aster—Glory of Colwall

DWARF ALPINE ASTERS

Alpinus. Indispensable for the rockery or edge of hardy borders; grows 6 to 10 inches high and bears large, showy bluish-purple flowers in May and June.

Alpinus Albus. Identical to the above, but with pure white flowers.

Sub-Coeruleus. Forms a dense tuft of leaves from which spring the flower stems about 12 inches high. The flowers are large, violet in color and are produced during June and July.

Price, 30c. each; doz., \$2.50; \$18.00 per 100.

TWO NEW HARDY ASTERS

Maggie Perry. Very large flowers, about 2 inches in diameter, loosely arranged in large trusses of a pleasing shade of mauve. Entirely distinct from any other hardy Aster. 35c. each; per doz., \$3.50.

Perry's White. This is without doubt the finest white hardy aster yet introduced; it is a strong grower and during the early Autumn the many branches are literally covered with large flowers, about 2 inches in diameter. The flowers are pure white with golden center and when fully developed the center turns crimson, a striking combination. 35c. each; per doz., \$3.50.

NEW JAPANESE HARDY ASTER

Mauve Cushion. An entirely distinct species. It forms a round cushion like plant from 8 to 10 inches in height in the center, tapering off to 3 to 4 inches on the outside. It is one of the last of the hardy plants to flower, usually coming into bloom the latter part of October and continuing through November, when it is completely covered with delicate mauve flowers, from 1 to 1½ inches in diameter. 30c. each; per doz., \$2.50; per 100, \$18.00.

ARTEMISIA LACTIFLORA

Unlike the other varieties offered, which are grown for their foliage, this comparatively new introduction from China is a most effective flowering plant, with erect stems 3½ to 4½ feet high, clothed with elegantly cut, dark green foliage and terminated by panicles of Hawthorn-scented, creamy white Spiraea-like light and graceful flowers. It is at its best from the latter part of August to the end of September, and is particularly valuable on this account, being unlike any other plant in bloom at that time. 30c. each; per doz., \$2.50; \$18.00 per 100.

Gentlemen:

West Chester, Pa.

The splendid plants reached me in fine shape. They will never know they have been moved.

Mrs. S. J. L.



Artemisia Lactiflora

ARMERIA (Sea Pink or Thrift)

Attractive dwarf plants that will succeed in any soil, forming evergreen tufts of bright green foliage, from which innumerable flowers appear in dense heads, on stiff, wiry stems, from 9 to 12 inches high. They flower more or less continuously from early spring until late in the fall. Very useful in the rockery.

Lauchena Rosea. Bright rose.

Lauchena Alba. White.

Price, either of the above, 30c. each; per doz., \$2.50; \$18.00 per 100.

ARTEMISIA

A most useful class of plants either for the border or for filling in within the shrubbery. With the exception of the variety *Lactiflora*, described and illustrated on page 118, they are not remarkable for their flowers; the foliage of the sorts offered is very ornamental. All these varieties offered stand cutting down to 5 or 6 inches when used in carpet or ribbon bedding.

Abrotanum (Old Man, or Southern-wood). Dark green, finely cut foliage, with pleasant aromatic odor; 2 feet.

Pedemontana. A handsome variety with finely cut silvery foliage.

Stelleriana (Old Woman). Deeply-cut silvery foliage; much used in carpet bedding; 18 inches.

30c. each; per doz., \$2.50; \$18.00 per 100.

ASCLEPIAS (Butterfly Weed)

Tuberosa. Very showy native plants, about 2 feet high, producing their flowers of brilliant orange-scarlet during July and August. 25c. each; per doz., \$2.50; \$15.00 per 100.

ASTILBE

The varieties offered below are stately, hardy plants, and succeed best in rather heavy soil and where they will not suffer for lack of moisture.

Davidi. An important hardy plant. Its 5 to 6 feet high stems, which rise from a tuft of pretty dark green foliage, are crowned with feathery plumes of deep rose-violet flowers during June and July.

Grandis. A grand species and a fine companion to *A. Davidi*, being of similar habit of growth, the panicles of white flowers frequently 2 to 2½ feet long; the foliage is much divided and attractive.

Either of the above, 50c. each; per doz., \$5.00.

Hybrida Moerheimeii. A strong growing hybrid of *A. Davidi*, attaining a height of 5 or 6 feet and producing well branched spikes of flowers 2 feet in length, of a beautiful creamy white. 75c. each.

Hybrida Salland. Another strong growing hybrid of *A. Davidi*, attaining a height of 6 feet and producing distinct red flowers different from all others. 75c. each.



Border Carnations

ASTILBE ARENDSII

This new type is the result of crossing *A. Davidi* with *A. Japonica Compacta*, *Astilboides* and *Thunbergii*. The plants are of very vigorous growth, 2½ to 3½ feet high, producing many branched feathered heads of flowers in June and July. They prefer a half-shady, moist position in any ordinary garden soil.

Ceres. Delicate light rose-colored flowers, with peculiar silvery sheen.

Salmon Queen. Graceful panicles of a beautiful salmon pink.

Vesta. Very graceful plumes of light lilac-rose.

Price, any of the above, 50c. each; doz., \$5.00.

AUBRETIA (Rock Cress; False Wall Cress)

The most popular evergreen trailers, with dense, cushion-like growth of silvery foliage and wonderfully free flowering in the spring. Perfectly hardy. Planted in the crevices of old walls and on rock ledges, it produces cascades of bloom.

Graeca. Blue. 30c. each; doz., \$3.00.

BAPTISIA (False Indigo)

Australis. A strong-growing plant, about 2 feet high; suitable either for the border or wild garden, with dark green, deeply-cut foliage and spikes of dark blue flowers in June.

Tinctoria. Spikes of bright yellow flowers in June; 2 to 2½ feet. Price, 30c. each; per doz., \$2.50; \$18.00 per 100.

BELLIS PERENNIS (English Daisy)

Improved double-flowering, white and pink, each separate. 20c. each; per doz., \$2.00; \$15.00 per 100.

BOCCONIA

(Plume Poppy, or Tree Celandine)

Cordata. A noble, hardy perennial, beautiful in foliage and flower; admirably adapted for planting in the shrubbery borders, centre of beds and in bold groups in almost any position. It will grow in any soil or situation, attaining from 6 to 8 feet in height; flowers in terminal panicles, of a creamy-white color during July and August. 30c. each; per doz., \$2.50; \$18.00 per 100.

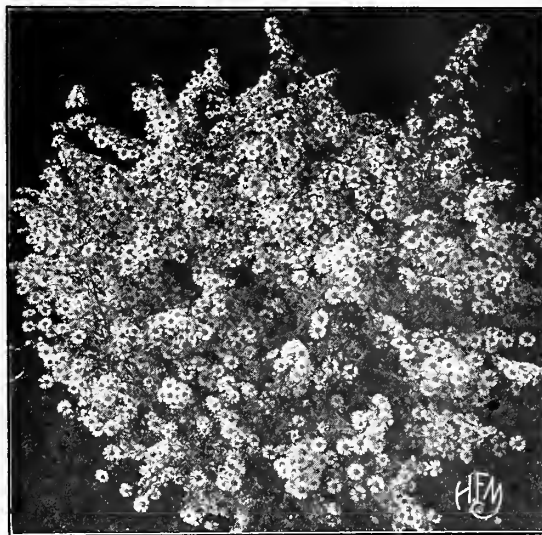

Boltonia Latisquama

BOLTONIA (False Chamomile)

Among the showiest of our native hardy perennial plants, with large single, Aster-like flowers. The plant is in bloom during the summer and autumn months, and with its thousands of flowers open at one time, produces a very showy effect. (See cut.)

Asteroides. Pure white; very effective; 5 to 7 feet.

Latisquama. Pink, slightly tinged with lavender, 4 to 6 feet. 30c. each; per doz., \$2.50; \$18.00 per 100.

HARDY BORDER CARNATIONS

Choice mixed seedlings produced from seed. We supply strong plants that will furnish an abundance of double flowers this season. 30c. each; per doz., \$2.50; \$18.00 per 100.



Campanula—Media

CAMPANULA (Bell Flower)

Showy perennial plants of special merit; some are tall, being suitable for borders; others are dwarf, for rockeries and edging. In every well-ordered hardy garden Campanulas should have a prominent place. They delight in a good rich loam, preferring a semi-shaded place. The taller varieties should be carefully staked, to prevent them from being broken during windstorms. If the flowers of Campanulas are cut as they fade it greatly prolongs the blooming period of the plant.

Calycanthema (Cup and Saucer). These are biennials, and last only one season, when planted in the autumn. Pink, white and blue, each color separate; height, 18 inches; June-July.

Media (Old-fashioned Canterbury Bells). This is a biennial type, like the Calycanthema, and will last only one season, when planted in the autumn. It flowers freely in June, July and August, and grows 3 to 4 feet high. Blue, pink and white, in separate colors.

Carpatica (Carpathian Harebell). A pretty species, growing in compact tufts, not exceeding 8 inches high; flowers clear blue, held erect on wiry stems. It begins blooming in June, continuing until October. As an edging for a hardy border or for the rockery, it is unsurpassed.

Carpatica Alba. The white-flowered form of above.

Pyramidalis (Chimney Bell Flower). The most conspicuous of all Campanulas, forming a perfect pyramid 4 to 6 feet high of porcelain blue flowers in August.

Any of the above, 30c. each; per doz., \$2.50; \$18.00 per 100.

CARYOPTERIS (Blue Splrea)

Handsome, free flowering perennials, of bushy habit; very valuable for their late blooming season. For bedding or pot culture.

Mastacanthus. Rich violet flowers produced in great profusion the whole length of the branches. 2 to 3 feet. September and October. 30c. each; per doz., \$2.50; \$18.00 per 100.

CASSIA (American Senna)

The Cassias delight in a sunny exposure. They are shrubby perennials, attractive for the finely cut foliage and showy, curious flowers.

Marilandica. Large panicles of yellow, pea-shaped flowers and attractive light green foliage. 3 to 4 feet. 30c. each; per doz., \$2.50; \$18.00 per 100.

CENTAUREA (Hardheads or Knapweed)

Of easy culture, delighting in an open, sunny position, producing a wealth of bloom, which not only makes a fine display in the border, but is excellent for cutting.

Montana (Perennial Corn Flower). Grows 2 feet high, bearing large violet blue flowers from July to September.

Montana Alba. Large white variety of the above. 30c. each; per doz., \$2.50; \$18.00 per 100.

CERASTIUM (Snow in Summer)

Tomentosum. A desirable low-growing plant with silvery foliage and white flowers in June; suitable for the rockery, or for carpeting dry, sunny spots, or for covering graves; can also be used with good effect in carpet bedding. 30c. each; per doz., \$2.50; \$18.00 per 100.

CHELONE (Shell Flower)

Glabra Alba. Terminal spikes of creamy white flowers.

Lyonii. Heads of showy purplish red flowers. 30c. each; per doz., \$2.50; \$18.00 per 100.

CIMICIFUGA (Snake Root)

Racemosa. A handsome native species bearing in July and August spikes of pure white flowers; well suited for planting at the back of the border, or for naturalizing at the edge of the woods; 4 to 6 feet. 35c. each; per doz., \$3.50.

SHRUBBY CLEMATIS

Recta. Grows 2 to 3 feet high and producing fragrant pure white flowers in large clusters during June and July.

Davidiana. A most desirable variety with fresh bright green foliage and bell-shaped flowers of deep lavender blue during August and September; very fragrant. 35c. each; per doz., \$3.50.

COREOPSIS

Lanceolata Grandiflora. Flowers rich golden yellow and of graceful form; fine for cutting. A few plants make a handsome display, either planted individually or in clumps; dozens of flowers are produced on a single plant, and where quantity and quality are wanted Coreopsis should be planted; June till October. 25c. each; per doz., \$2.50; \$15.00 per 100.

CORONILLA (Crown Vetch)

Varia. A rampant creeper, with handsome globular heads of showy, bright pink and white Sweet Pea-shaped flowers; a useful plant for covering rough banks or for the rockery. 30c. each; per doz., \$3.00; \$18.00 per 100.

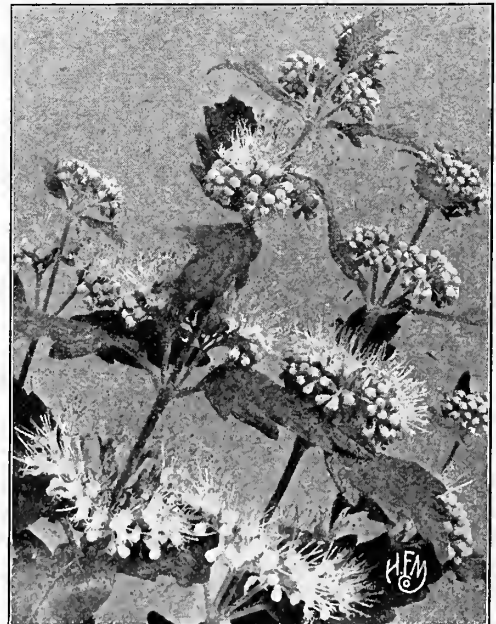

Caryopteris Mastacanthus

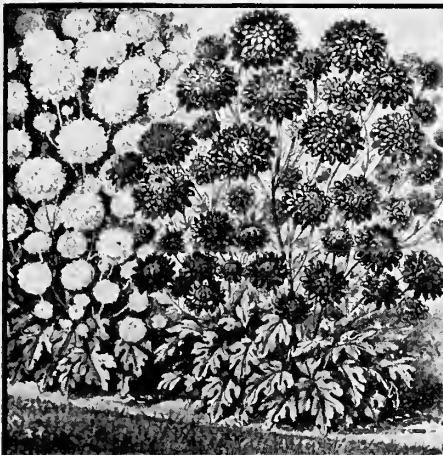

HARDY GARDEN

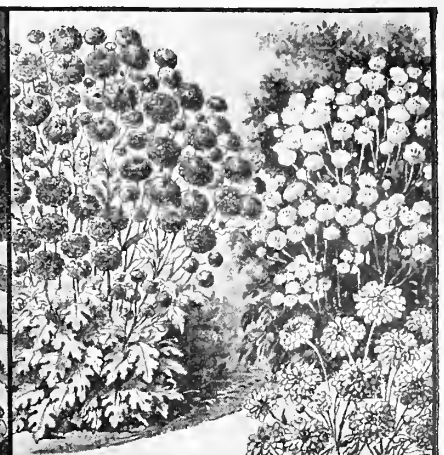

CHRYSANTHEMUMS.

These showy and effective favorites are now universally popular. When planted outside they extend the flowering season of your perennial garden, blooming profusely in October after other flowers have been browned by early frosts, which do not affect the Chrysanthemums, producing a wealth of bloom especially fine for cutting. They should be planted in a well drained position either in the hardy border or at the edge of a shrubby border. The planting should be done early in the Spring, so that the plants will have the entire Summer to establish themselves, and late in the Autumn, after they have finished flowering and the tops have been cut off they should have a covering of leaves or loose litter as a Winter protection, but do not cover with manure. Early in the Spring after danger of severe freezing is over and before any growth starts, the covering should be removed.

A. Barham (*Large Flowering*). A beautiful orange-bronze; early.
Baby (*Button*). Everybody's favorite. The smallest yellow variety grown.

Cranfordia (*Large Flowering*). In this variety we have an early flowering Chrysanthemum that covers every possible point, perfect in flower, stem and foliage. Each plant will carry from 10 to 12 beautifully finished flowers of a deep bronze yellow; should be in every collection.

Ethel Blades (*Large Flowering*). Very large flowers of a rich chestnut red, one of the best of the early flowering sorts.

Fairy Queen (*Pompon*). A delightful clear shade of pink of medium size, round and full.

Fee Parisienne (*Large Flowering*). Large deep rose flowers; early.

Glory of Seven Oaks (*Large Flowering*). Golden yellow; dwarf and very free.

Golden Climax (*Pompon*). Orange yellow, one of the finest yellows now in cultivation. This variety has been admired more than almost any other in the various Chrysanthemum Shows.

Iva (*Button*). Very small deep bronze.

Josephine (*Single*). Brilliant yellow in color; heavy textured flower; perfectly rigid stems and if disbudded will produce a flower 6 inches across.

L'Argentuillius (*Large Flowering*). Deep chestnut shaded crimson, coming into flower early in October. Very strong grower and free bloomer.

La Garonne (*Large Flowering*). Lemon yellow suffused coppery bronze; large flowers produced individually rather than in clusters.

Lilian Doty (*Pompon*). The finest pink in the large flowering section of the Pompon family. A strong grower and producing beautiful sprays of clear light pink flowers.

Minta (*Button*). A very free flowering light pink variety.

Mrs. Nellie Kleris (*Pompon*). An improved Lilian Doty, but the color is more evenly diffused over the flower. The flowers are equally as large as Lilian Doty and the plant is a fine sturdy dwarf grower.

Mrs. Chester Robinson (*Pompon*). A tall strong grower with large flowers of a deep old rose pink.

Myer's Perfection (*Button*). A fine pure white, tall growing variety.

Price of any of the above, 20c. each; per doz., \$2.00; \$12.00 per 100.

Nellie Irwin (*Pompon*). A true Pompon; clear bright yellow in color and having fine clean foliage and stiff stems.

Miss Mary Pope (*Single*). A pale pink with a very large flower; early; one of the best.

Oconto (*Large Flowering*). A Japanese variety with white flowers, on strong stiff stems; early.

Provence (*Large Flowering*). Light pink; early.

Rosea (*Large Flowering*). Early, rose-pink.

Ruby Queen (*Pompon*). A dwarf growing variety with deep pink, almost crimson flowers. One of the best varieties of this color.

White Doty (*Pompon*). A sport of the popular variety Lilian Doty, identical in every way except color, which is a pure milk white.

Price of any of the above, 20c. each; per doz., \$2.00; \$12.00 per 100.

HARDY CHRYSANTHEMUMS FOR POT CULTURE

Betsy Presby. Quilled petals, orange yellow; pretty and free.

Ethel Beers (*Single*). Chestnut bronze, 2½ inches in diameter; very free; one of the finest singles.

Grace Darling (*Single*). Pure white flowers with yellow centers; quite large and about four flowers are open at one time on a stem; very free.

Graf von Fleming (*Anemone*). This is a charming variety, color of the purest pale lavender; the petals of this exquisite flower are very narrow and refined; the outer petals are tubular until they reach the edges where they open and droop back.

Inocenza (*Anemone*). Outer petals of pure white; central petals most beautifully flushed pale pink; edges of the tubular petals in center of light yellow; fine growth; an excellent variety.

Kathleen Thompson (*Caprice*). Large flowers of reflex type. Color is old gold suffused bronze and yellow. A spray of this consists of 5 to 6 flowers, almost a bouquet in itself. Everyone who grows Chrysanthemums should not fail to have this variety in their collection.

Lelia (*Button*). Splendid scarlet bronze in color; tall and handsome; flower quite large.

Mrs. W. E. Buckingham (*Single*). Mid season pink; has proved itself one of the best varieties for cutting ever introduced. We cannot recommend this variety too highly.

Thelma (*Pompon*). Bronzy red, unique in color among pompons; very early and free.

Price of any of the above, 20c. each; per doz., \$2.00; \$12.00 per 100.

CHRYSANTHEMUM (Shasta Daisy)

Arcticum (*The Arctic Daisy*). Among fall-flowering perennials, this is a perfect gem. In September multitudes of pure white flowers appear, from 2 to 2½ inches in diameter. These begin to develop during the last week in September, and continue in good condition throughout October, and frequently into November.

Shasta Daisy (*Alaska*). A decided improvement on the original, with blooms 4½ to 5 inches across, of pure glistening white. Very free-flowering and in bloom all summer and fall.

Price of the above, 30c. each; per doz., \$2.50; \$15.00 per 100.

MICHELL'S HARDY PERENNIAL PLANTS

DELPHINIUMS OR HARDY LARKSPURS

In view of the wonderful display that Larkspurs make, it is worth while to exercise care in locating a most suitable position and in the preparation of the ground, the latter should have a good natural drainage. Never use animal manure in planting Delphiniums, unless it has been incorporated in the soil a year before planting. Pure bone-meal is the best fertilizer in promoting growth; apply with it also some wood ashes; the latter will assist in holding in check earth grubs, which at times attack the roots and crowns of the plant. In order to keep Larkspurs in bloom continuously during the summer, cut the old flower stems off, after they have faded, and new shoots will produce flower heads in succession. To get the best out of hardy Larkspurs in the way of flowers, feed them occasionally during the growing season with an application of ground bone. A slight covering of long straw or leaves over the crowns of the plants during winter will prove a great benefit.

Belladonna. The freest and most continuous blooming of all, never being out of flower from the end of June until cut down by hard frost. The clear turquoise-blue of its flowers is not equalled for delicacy and beauty by any other flower.

Bellamosum. A dark blue form of Belladonna with which it is identical excepting in color, which is a rich deep blue.

Chinense. A very pretty dwarf species, with fine feathery foliage and intense gentian-blue flowers in open panicles.

—**Album.** A pure white form of the above.

Formosum. The old favorite dark blue with white centre; 3 to 4 feet high. Very vigorous, and one of the best.

MicHELL'S Gold Medal Hybrids. Unquestionably the finest strain of mixed hybrids offered. The original stock came from England, and consisted of the best-named varieties. The plants are of strong, vigorous habit, with large flowers on spikes two feet and over long, the majority running in the lighter shades of blue. We can supply them in mixture only.

Price. Any of the above. 30c. each; \$2.50 per doz.; per 100, \$15.00.

DIANTHUS (Garden Pinks)

These are brilliantly colored flowers, which appear in great numbers on the plant, and have a rich clove scent. For table bowls, as a cut flower, they are much in use. For edging hardy borders, garden walks, or planted in rock gardens, they fill an important place. They are at their height of bloom in June.

Deltoides (Maiden Pink). A continuous flowering variety with pink flowers. Especially suited for rock work.

Deltoides Alba. White flowers.

Latifolius Atrococcineus Fl. Pl. (Ever-blooming Hybrid Sweet William.) A splendid variety with brilliant crimson, double flowers. Flowers continuously during the entire season.

Any of the above. 30c. each; doz., \$2.50; per 100, \$15.00.



Diclytra Spectabilis



Hardy Delphinium

DICTAMNUS (Gas Plant)

A genus of very ornamental plants deserving a place in every flower border. The plant when rubbed emits a strong, fine odor, something like that of lemon peel, which is strongest in the pedicels of the flowers. Of easy culture and valuable for cutting.

Fraxinella. Racemes of curious red flowers with decided balsamic scent. 2 feet to 2 feet 6 inches. May to July.

Fraxinella albus. Spikes of attractive pure white, sweet-scented flowers, valuable for cutting and lasting a long while in water. 2 feet. May to July.

35c. each; per doz., \$3.50.

DIGITALIS (Foxglove)

These are showy plants, but are biennials (that is, live outdoors for two seasons), but can be made perennial by the following treatment: Immediately after blooming remove the flower stalk right down to the ground, also crop some of the large leaves; the result is, a number of new plants start from the old crown, which produce splendid flowers the second year. Digitalis will do well in semi-shaded spots; plants grow from 4 to 6 feet high; flower in June.

Gloxinaeflora. White, pink, purple, lilac. Each separate.

Grandiflora. Yellow.

Lanata. A distinct species, producing dense spikes of curious-looking flowers, the corolla being gray, the lips white.

Any of the above, 25c. each; doz., \$2.50; per 100, \$15.00.

DIELYTRA or DICENTRA

(Bleeding Heart or Seal Flower)

Spectabilis. We are fortunate in again being able to offer this old fashioned favorite, its long sprays of graceful heart shaped flowers are always attractive. A most satisfactory plant for the hardy border, especially when it can be planted in the shade. Strong clumps 50c. each; per doz., \$5.00.

Gentlemen:	Cincinnati, Ohio.
Plants have arrived in good shape.	H. K.

ECHINOPS (Globe Thistle)

Ritro. Interesting and showy thistle-like plants with globular heads of deep metallic blue flowers, which can be dried, and remain attractive for a long time; 2 to 3 feet. 25c. each; \$2.50 per doz.; \$15.00 per 100.

EPIMEDIUM (Barren-wort; Bishop's Hat)

Dwarf-growing plants, 8 to 10 inches high, with leathery foliage and panicles of interesting flowers; the foliage assumes the most beautiful tints of color in autumn. Mixed colors only. 30c. each; \$2.50 per doz.; per 100, \$18.00.

ERYNGIUM (Sea Holly)

Handsome ornamental plants, growing from 2 to 3 feet high. Effective in flower and shrubby border, woodlands, wild gardens, etc.; the flower heads which are produced from July to September, are useful to cut for vases or to dry for winter bouquets.

Amethystinum. The finely-cut, spiny foliage and the beautiful thistle-like heads are of glistening amethystine-blue. A most ornamental plant. 35c. each; \$3.50 per doz.



HARDY FERNS

Many persons are perplexed to know what is best suited for planting in densely shaded borders, particularly around porches. Nothing in the world produces such a permanent and satisfactory effect as Ferns. The graceful plants grow on an average from 1 to 2 feet high, according to the variety, and the clumps increase in size and beauty each year. They die down in the winter and break forth again in May.

- ADIANTUM Pedatum** (Maidenhair Fern). 12 inch.
- ASPIDIUM Acrostichoides**. Christmas Fern. 12 inch.
- ASPLENIUM Filix-Foemina** (Lady Fern). 12-15 inch.
- CYSTOPTERIS Bulbifera** (Bulbel Bladder Fern). 24 inch.
- DICKSONIA Punctilobula** (Gossamer Fern). 18 inch.
- ONOCLEA Struthiopteris**. Ostrich Fern. 24-36 inch.
- **Sensibilis**. Sensitive Fern. 12 inch.
- OSMUNDA—Cinnamonea**. Cinnamon Fern. 24 inch. 50c. each; per doz., \$5.00.
- **Claytoniana**. 24 inch. 50c. each; per doz., \$5.00.
- WOODSIA Illyvensis**. Excellent for rock-work, requiring little soil and thriving best in the sunniest corner. 6 inch.

Price, any of above, except where noted, 30c. each; per doz., \$2.50; \$18.00 per 100.

EUPATORIUM

Ageratoides (Thorough Wort). A useful border plant of strong, free growth, 3 to 3½ feet high, with minute white flowers in dense heads; splendid for cutting; August and September.

Coelestinum. A pretty hardy plant, with light blue flowers similar to the Ageratum. This is a particularly fine thing in hardy perennials; a splendid cut flower. 18 to 24 inches. 30c. each; per doz., \$2.50; \$15.00 per 100.

EUPHORBIA (Milk Wort)

Corollata (Flowering Spurge). A most showy and useful native plant, growing about 18 inches high and bearing from June to August umbels of pure white flowers, with a small green eye; desirable for cutting.

— **Polychroma.** Very effective in the spring, when it bears masses of chrome-yellow flowers. 30c. each; per doz., \$2.50; \$18.00 per 100.

FUNKIA (Plantain Lily; Day Lily)

Japanese perennials producing attractive clumps of foliage and interesting lily-like blossoms. A continuous row along a walk gives a strong and pleasing character. Delight in moist, shady situations. The variegated foliage of some species is extremely beautiful and striking for decorative work.

Lanceolata. Valuable by reason of its late flowering; lilac flowers in September; 2 feet.

Coerulea. Blue, broad green leaves; June; 4 feet.

Subcordata Grandiflora. Very large, pure white, lily-shaped, fragrant flowers in August and September; 2½ to 3 feet. 50c. each; per doz., \$5.00.

Undulata Media Picta. Green and white variegated foliage; purple flowers. Makes a fine edging; July; 2 feet.

Price (except where noted). 30c. each; per doz., \$2.50; \$18.00 per 100.

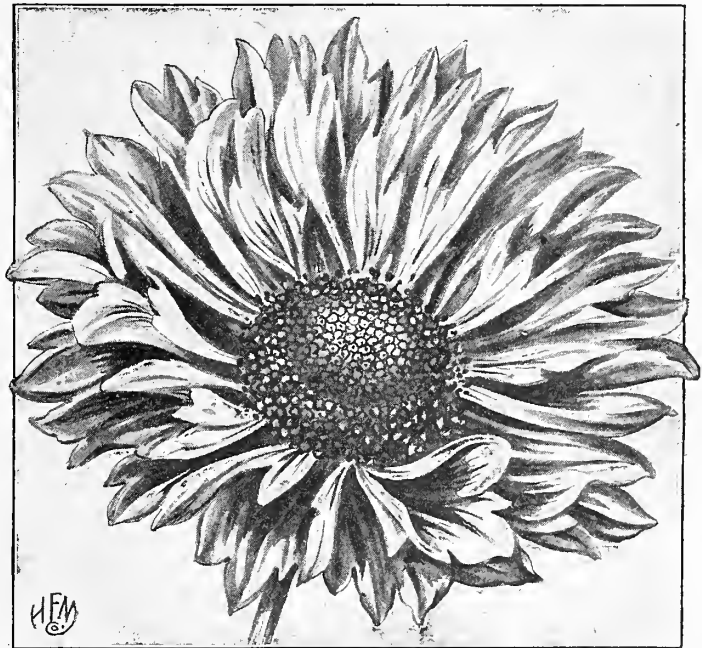

Gaillardia, Grandiflora Superba

GAILLARDIA (Blanket Flower)

Beautiful flowers are borne in profusion and make a striking effect. They last a long while as a cut flower, and are abundant from June until frost. Height, about 2 feet.

Grandiflora. Dark brown centre, petals on the outer edge are yellow, and the centre is surrounded with a rich orange disc. 25c. each; per doz., \$2.50; \$15.00 per 100.

GEUM (Avens)

Well-known plants noted for their rich coloring and freedom of flowering. Useful for cutting and the rockery or border. May to July.

Atrosanguineum Fl. Pl. Large blood-red flowers in open heads. 1 to 2 feet.

Coccineum, Mrs. Bradshaw. Twice the size of the old double scarlet, with huge frilled petals, giving a full, double appearance. 6 to 10 inches.

30c. each; per doz., \$2.50; \$18.00 per 100.

MICHELL'S HARDY PERENNIAL PLANTS

GILLENIA (Bowman's Root)

Trifoliata. A desirable strong growing perennial, suitable for the mixed border or for planting in connection with shrubs. Handsome trifoliolate foliage and numerous white flowers tinged with pink. 30c. each; per doz., \$2.50; \$18.00 per 100.

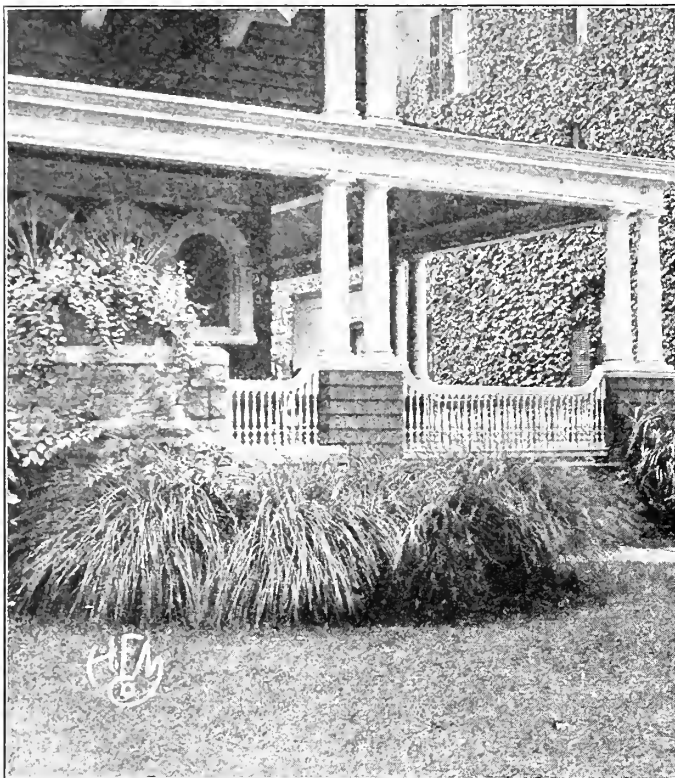

Pennisetum Japonicum

GRASSES (Hardy Ornamental)

The generous beautiful effect produced by the hardy Grasses is hard to describe. Plantings must be seen to be appreciated. Excellent as individual specimens.

Elymus Glaucus (*Blue Lime Grass*). A graceful growing type with narrow silvery blue foliage; a dwarf compact grower; height, 3 feet.

Erianthus Ravennae (*Plume Grass or Hardy Pampas*). Deep green narrow foliage, growing about 10 feet high.

Eulalia Gracillima Univittata (*Japan Rush*). Graceful narrow foliage, growing 5 to 6 feet. Green, with silvery rib.

Eulalia Japonica Variegata. An attractive variety with a variation of markings of white, green, sometimes light pink and yellow; 4 to 5 feet high.

Eulalia Japonica. Like the variegated variety, except that it is entirely green.

Eulalia Japonica Zebrina. Dark green foliage, crossmarked horizontally golden yellow. One of the best of hardy Grasses.

Phalaris Arundinacea Variegata (*Variegated Ribbon Grass or Gardener's Garter*). This sort is especially suited for edging taller varieties, as it grows somewhat dwarf. The foliage is somewhat broad, variegated white and green. 12 to 15 inches.

Pennisetum Japonicum (*Hardy Fountain Grass*). One of the most valuable hardy Grasses, either for beds, mixed borders or as individual specimens. Height, 4 feet.

Price of Hardy Grasses, 35c. each; doz., \$3.50; \$22.00 per 100.

GYPSOPHILA (Baby's Breath)

During August and September this is a mass of delicate flowers. These may be used as fresh cut flowers, also for a semi-everlasting effect. They keep for months without water.

Paniculata. Feathery sprays of white flowers; useful for effects in bouquets. 30c. each; doz., \$2.50; \$15.00 per 100.

HELIANTHEMUM (Sun Rose)

A very pretty family of evergreen plants, covered during May and June, and more or less throughout the summer, with flowers of the most brilliant colors; valuable for rockeries.

Hyssopifolium. Copper colored flowers; large glossy leaves.

Perfoliatum Roseum. Salmon pink flowers with yellow center.

Vulgaris Flora Pleno. Yellow flowers; very double.

Price, 25c. each; doz., \$2.50; \$15.00 per 100.



Helioipsis

HELIOPSIS (Orange Sunflower)

This genus is very similar to the *Helianthus*. They are tall-growing plants, well suited for the back of flower borders, where they flower beautifully throughout the summer.

Pitcheriana. One of the best hardy plants for the perennial border. Daisy-shaped flowers of deep orange color, on good stems for cutting. 2 to 3 feet.

Scabra Excelsa. A new variety with very rich chrome-yellow flowers, turning to a bright yellow as they mature. These are almost double, having from 4 to 5 rows of petals, and are produced very profusely. The plant is of robust growth, about 3 feet high. Mid-July to the end of August.

Price, 30c. each; doz., \$2.50; \$18.00 per 100.



Helanium, Autumnale Superbum

HELENIUM (Sneezewort)

These desirable perennials succeed in almost any soil, in a sunny location. The flowers are splendid for cutting.

Autumnale Rubrum. Bright, terra-cotta red; 5 feet.

Autumnale Superbum. Massive spreading heads of deep golden yellow flowers; August-October; 5 feet.

Riverton Beauty. Rich lemon-yellow, with large purplish-black cone; August and September; 4 feet.

Price, 30c. each; per doz., \$2.50; \$18.00 per 100.

HEUCHERA (Alum Root or Coral Bells)

Sanguinea. Bright crimson flowers, borne in graceful sprays; excellent for cutting. 30c. each; doz., \$2.50; \$18.00 per 100.



Helianthus Multiflorus Fl. Pl.

HELIANTHUS (Hardy Sunflower)

Very effective in borders, among shrubbery or as clumps on the lawn, etc. They produce masses of flowers during summer until frost, which are splendid for cutting and decorative purposes.

Maximiliana. The latest of all, blooming profusely in October; the fine golden yellow flowers appear in long graceful sprays; splendid for cutting; 5 to 7 feet.

Meteor. Large double orange-yellow flowers with bold yellow guard petals; 5 feet; August and September.

Multiflorus Fl. Pl. Large, double golden yellow; July-August; 4 feet.

Orgyalis (Willow Leaved or Skyrocket Sunflower). Long, graceful foliage, bright yellow flowers on short stalks. 6 to 8 feet. October.

Rigidus Japonicus. One of the most desirable varieties, beginning to bloom early in July and continuing until fall; flowers golden-yellow, with dark centres; 5 feet.

Price, 30c. each; doz., \$2.50; \$18.00 per 100.

HEMEROCALLIS (Yellow Day Lily)

Lily-like plants, flowering in great profusion during the summer, making a fine cut bloom.

Aurantiaca. Large, trumpet-shaped, orange yellow flowers; reverse of petals bright Indian yellow; sweet scented.

Dr. Regel. Handsome, rich-orange-yellow flowers in May, very fragrant and fine for cutting.

Dr. Sovereign. Lovely chrome-yellow flowers during June and July.

Fulva (Tawny Day Lily). Trumpet shaped flowers; coppery orange shaded crimson; June and July.

Kwanso Flore Pleno (Double). Coppery red; July; 3 feet high. Price, 30c. each; doz., \$2.50; \$15.00 per 100.

HIBISCUS (Mallow)

Giant Flowering. A wonderfully improved form of our greatly admired Marsh Mallows. They are unusually attractive and form real show plants during their flowering season. They attain a height of 6 to 7 feet, have beautiful lacinated foliage and monstrous flowers, measuring from 6 to 8 inches in diameter. We offer these in separate colors. Red, pink, and white. 35c. each; doz., \$3.50; \$25.00 per 100.

Mixed all colors, 25c. each; doz., \$2.50; \$15.00 per 100.

HYPERICUM (St. John's Wort)

Moserianum. A most desirable border plant, of free and graceful habit, producing long, slender, much-branched stems, leafy to the base and all drooping towards the ends, apparently from the weight of the flowers and buds, although the flowers face, so none of their beauty is lost. Free-flowering, of large size, measuring from 2 to 2½ inches in diameter; color rich golden yellow, which is rendered still more effective by the numerous yellow stamens and crimson anthers; blooms continuously. 2 feet. Strong plants, 30c. each; per doz., \$2.50; \$18.00 per 100.



Michell's Double Hollyhock

HOLLYHOCKS (Double)

These thrive best in soil that is not too wet, which should be enriched with well-rotted stable or sheep manure. While perfectly hardy, we recommend protecting them slightly during the winter with leaves, long manure or straw. To guard against fungus or rust we recommend spraying the plants in early spring with Pyrox or Bordeaux Mixture.

Our strain of these is very fine, and we offer the following colors in double flowering only (each separate):

Yellow Crimson, Pink, White. 30c. each; doz., \$2.50; \$18.00 per 100.

IBERIS (Hardy Candytuft)

The Hardy Candytufts are low-growing plants, with evergreen foliage. In spring and early summer they are completely covered with dense heads of pure white flowers. For borders and rockeries they are unsurpassed.

Snowflake. Pure white, of fine form and compact habit; blooms very early; height, 9 inches.

Sempervirens. Pure white flowers; 1 foot. 30c. each; doz., \$2.50; \$18.00 per 100.

IRIS (Oriental and Siberian)

The flowers resembling the Spanish and English Iris. These make a bright show in the garden and are also excellent for cutting. They can be cut when in bud and will fully develop in water. Blooms from latter part of May until end of June.

Blue King. Clear blue. Found by Mr. Peter Barr in Japan.

Sanguinea. Intensely brilliant blue flowers, the bud being inclosed in conspicuous crimson spathe valves.

Superba. Large, violet blue; handsome foliage, reaching almost to the flowers. 2 to 3 feet.

Iris Siberica. Purplish blue; 3 feet high; very desirable. June.

Iris Siberica Alba. Fine white. June.

30c. each; doz., \$2.50; \$18.00 per 100.

IRIS PUMILA HYBRIDA

The first of the Iris to bloom, resembling in appearance the Germanica variety; the plants are about 6 inches high and are ideal when used as an edging for taller varieties or in borders or rockeries; they delight in a fairly dry, high situation, and once planted will increase in numbers rapidly.

Cyanea. Rich royal purple with blackish shadings.

Excelsa. A splendid pale lemon yellow.

The Bride. A large showy pure white.

Price, 30c. each; doz., \$2.50; \$18.00 per 100.

See next page for German and Japanese Iris.

MICHELL'S HARDY PERENNIAL PLANTS

IRIS GERMANICA (Fleur de Lis)

No garden or perennial border is complete without a planting of Iris; they thrive most anywhere, being absolutely hardy under most all conditions.

Aurea. Very large flower; finest yellow.

Bridesmaid. White, shaded silvery lilac.

Dr. Bernice. Brown with purple falls.

Eldorado. Yellowish bronze, shaded lavender.

Eugene Sue. Creamy white, spotted and striped purple.

Florentine Alba. Very free blooming white.

Gypsy Queen. Lavender bronze, veined white.

Honorabilis. Golden yellow, shaded rich bronze.

Innocenza. Pure white; early and very beautiful.

Laura. Beautiful shade of lavender blue.

Lohengrin. Lilac rose; very large flower. 50c. each; per doz., \$5.00.

Loute. Upright petals, light blue and heliotrope; falls reddish purple and bronze, a striking color.

Mad. Chereau. White, edged light blue.

Mad. Paquette. Deep claret red, nearly solid red.

Mrs. H. Darwin. White standards; violet blue falls, which are turned over in graceful fashion.

Ossian. Straw-yellow standard, with bluish violet falls.

Pallida Dalmatica. One of the finest of the Germanica type; of vigorous habit and bearing very large fragrant flowers; standards lavender, falls lavender shaded blue; one of the best. 35c. each; per doz., \$3.50; \$20.00 per 100.

Pallida Mandraliscae. Beautiful rich lavender purple; very large handsome flower. 35c. each; per doz., \$3.50.

Pallida Speciosa. Standards dark lavender with light purple falls; free flowering. 35c. each; per doz., \$3.50.

Parisiensis. Large, showy, deep purple flowers.

Queen of May. Light pink; very early.

Rhein Nixe. Standards pure white, falls deep violet blue, margined white. 50c. each; per doz., \$5.00.

Price of any of the above, except where noted, 25c. each; per doz., \$2.00; \$12.00 per 100.

Mixed German Iris. 15c. each; per doz., \$1.50; \$10.00 per 100.

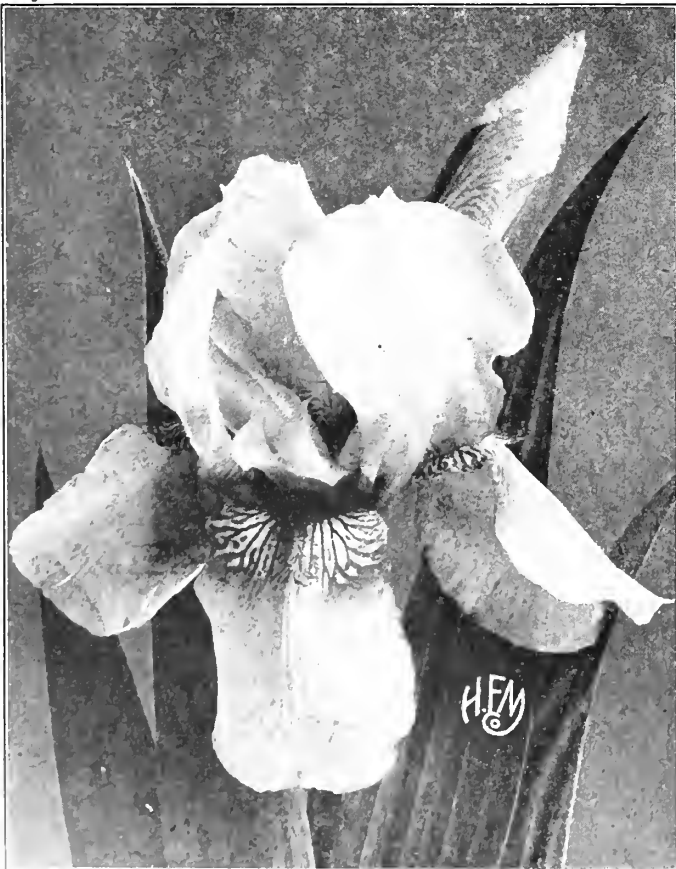

Iris Germanica

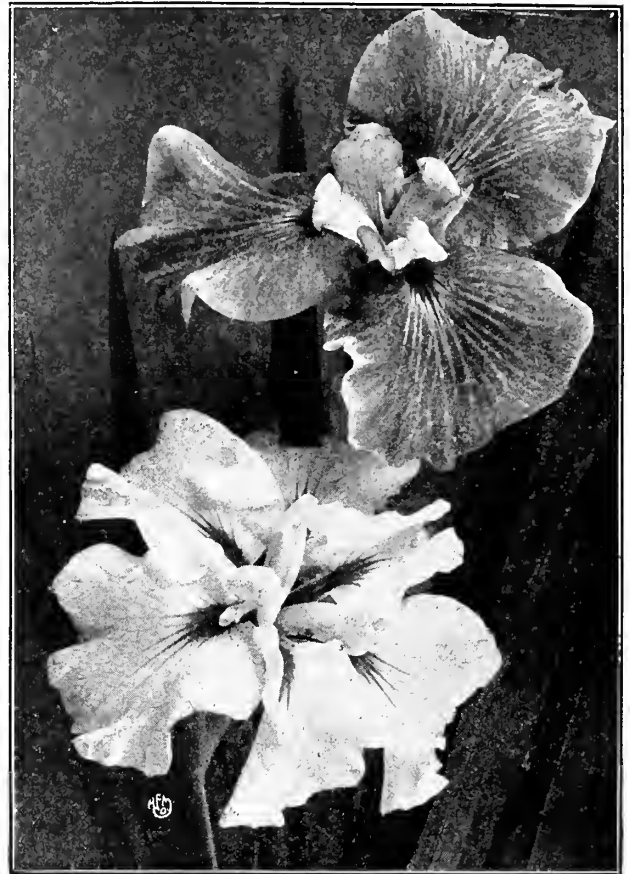

Iris Kaempferi

IRIS KAEMPFERI (Japanese Iris)

The King of all Iris and in popularity they can be classed with the Hardy Phlox and Paeonies; coming into flower about the middle of June, they continue for five or six weeks and are particularly welcome at this time. They succeed in almost any soil and like plenty of water when forming their flower buds. Valuable as cut flowers, but they should be cut in the bud state allowing the blooms to expand in water. If desired Japanese Iris may be ordered by the number prefixed to the variety.

1. **Bandai-No-Nami.** Clear white, with fringed center; double.
3. **Kichi-Cohuo.** White; single.
4. **Ho-o-Jo.** Rich velvety purple; double.
5. **O-Sho-Kun.** Dark tyrian blue; white veins; double.
6. **Shippo.** Rich tyrian blue, white lined; double.
8. **Yudo-No-Komura.** Deep rose pink.
10. **En-U-No-Sora.** Pink, reddish standards; single.
22. **Suiren.** Very light lavender; double.
34. **Sassa-No-Koe.** White, pink lined; single.
43. **Summa-No-Ura.** Light blue, darker spotted.
60. **Uchiu.** Light lavender; very double.
75. **Yedo-Jiman.** Dark violet, purple center; double.

Any of the above named sorts of Japanese Iris. 35c. each; doz., \$3.50; \$25.00 per 100.

Mixed Japanese Iris. All colors and shades. 20c. each; doz., \$2.00; \$15.00 per 100.

IRIS INTERREGNA

An entirely distinct type being a cross between a German Iris and Iris Pumila. It is medium early to bloom, flowering in between Iris Pumila and Iris Germanica. Plants grow about 18 inches high and are surmounted with large flower heads, on spikes, which grow well above the foliage, appearing in May.

Ceres. Standards and fall pearl white, orange beard.

Walhalla. Standards light blue, violet blue falls, yellow beard.

Price of the above, 30c. each; doz., \$2.50; \$18.00 per 100.

For other varieties of Iris, see page 125.

LATHYRUS (Everlasting or Perennial Sweet Pea)

The perennial pea is one of the hardiest and most easily cultivated species, thriving almost anywhere. It is a good trellis plant, and is adapted as a cover to wild, rough places.

Latifolius. Large deep red flowers on long stems in constant succession. 6 feet.

— **Albus.** White flowers.

— **Pink Beauty.** Clusters of large beautiful shell-pink flowers. Price, either of above, 30c. each; doz., \$2.50.

— **White Pearl.** Most beautiful of all everlasting peas with pure white flowers, which are about double the size of the ordinary *Lathyrus Latifolius albus*. Price, 50c. each; doz., \$5.00.

LAVENDULA (Lavender)

Vera. This is the true Sweet Lavender; grows about 18 inches high; delightfully fragrant blue flowers in July and August. 30c. each; per doz., \$2.50; \$18.00 per 100.

LIATRIS (Blazing Star, or Gay Feather)

Pycnostachya. Showy and attractive native plants, succeeding anywhere, producing large spikes of light rosy-purple flowers in July and August; 5 feet. 30c. each; \$2.50 per doz.; per 100, \$15.00.

LINUM (Flax)

Perenne. A desirable plant for the hardy border or rockery; light graceful foliage and large blue flowers all summer. 30c. each; per doz., \$2.50; \$18.00 per 100.

LOBELIA

Handsome border plants thriving in any good garden soil but preferring a moist loam where they will not suffer from drought.
Cardinalis (Cardinal Flower). Rich fiery cardinal flowers. 30c. each; doz., \$2.50; \$15.00 per 100.



Lupinus Polyphyllus

LUPINUS (Lupins)

These flower in May and June; are 3 to 4 feet high. In dry weather water liberally to prolong the bloom.

Polyphyllus Blue. Very showy.

Polyphyllus White.

Polyphyllus Pink.

Price, 50c. each; doz., \$5.00.

LYTHRUM

Roseum Superbum (Rose Loose-strife). A strong-growing plant, 3 to 4 feet high, thriving in almost any position, producing large spikes of rose-colored flowers from July to September. 30c. each; \$2.50 per doz.; per 100, \$18.00.

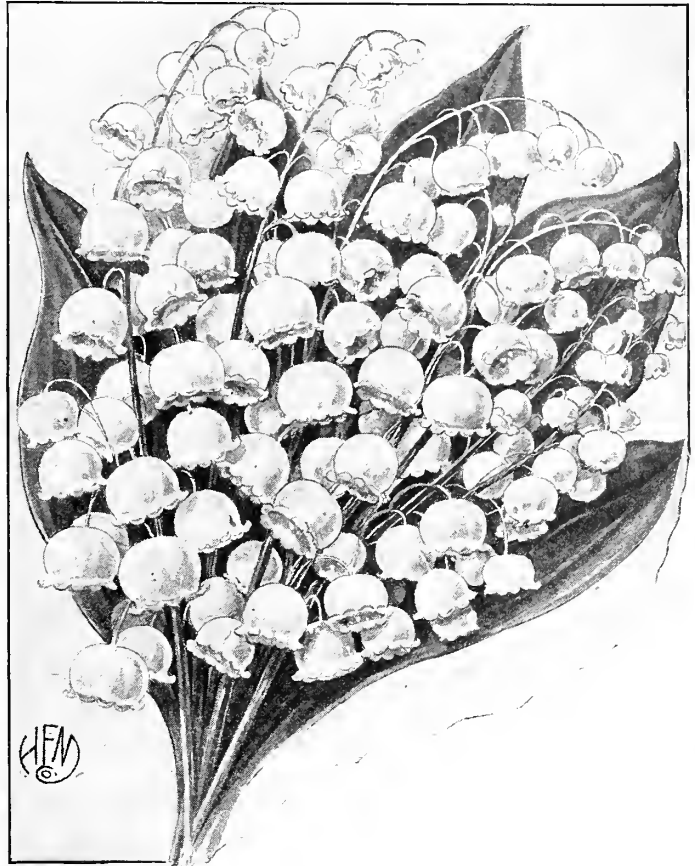

Lily of the Valley

LILY OF THE VALLEY

For outdoor planting in shaded places. Pure white flower bells appear on stems about 8 to 10 inches long, the latter part of May. Clumps, 50c. each; doz., \$5.00; \$40.00 per 100. Stock cannot be shipped after May 15th.

LYCHNIS (Campion)

All of the *Lychnis* are of the easiest culture, thriving in any soil and this, in addition to their brightness, has brought them into high favor with lovers of hardy plants.

Chalcedonica. A most desirable plant, heads of brilliant orange-scarlet in June and July. Grows 2 to 3 feet high.

Chalcedonica Alba. A white-flowered form of above.

Haageana Hybrids. Brilliant orange-scarlet flowers in May and June; 12 inches.

Viscaria. Forms a dense tuft of evergreen foliage, and in June sends up spikes of handsome, double, deep red flowers; 1 foot.

Price, 30c. each; doz., \$2.50; per 100, \$18.00.

LYSIMACHIA

Ciliata (Fringed Loose-strife). Yellow flowers in July; 2 feet.

Clethroides (Loose-strife). A fine hardy variety about 2 feet high, with long, dense, recurved spikes of pure white flowers from July to September.

Nummularia (Creeping Jenny, or Money-wort). Valuable for planting under trees or shrubs where grass will not grow, where it quickly forms a dense carpet.

Price, 30c. each; doz., \$2.50; \$18.00 per 100.

MATRICARIA (Feverfew)

Little Gem. Pure white, double flowers, splendid for cutting, flowering July and August; height, 12 inches; ideal for open sunny border. 30c. each; doz., \$2.50; \$15.00 per 100.

MERTENSIA (Blue Bells)

Virginica. An early spring flowering plant growing 1 to 1½ feet high with drooping panicles of handsome light blue flowers fading to clear pink; one of the most interesting of our native spring flowers; May and June. 30c. each; doz., \$2.50; \$15.00 per 100.

MICHELL'S HARDY PERENNIAL PLANTS

MONARDA (Bergamot)

Didyma Cambridge Scarlet (*Oswego Tea*). Crimson scarlet.
Didyma Rosea (*Bee Balm*). Flowers of a rose color, and sweetly fragrant foliage; 18 inches; July to September.
Fistulosa Alba (*Wild Bergamot*). Pure white flowers in whorls. Leaves cordate and highly scented; 3 feet; June to September. Price, 30c. each; doz., \$2.50; \$18.00 per 100.

MYOSOTIS (Forget-Me-Not)

These are most effective when intermingled with Pansies, English Daisies or amongst summer-flowering perennials. They bloom usually about the middle of April, and last well into the summer.
Alpestris Victoria. A grand variety, with fine heads of clear azure blue flowers; bushy and compact, a fine edging plant.
Palustris Semperflorens (*Perpetual Flowering Forget-me-not*). Blue with yellow throat; damp places; spread rapidly. 9 inches. 20c. each; doz., \$2.00; \$15.00 per 100.

NIEREMBERGIA (Cup Flower)

Rivularis. A lovely dwarf creeping Alpine plant, producing large cup shaped flowers, creamy white in color, from June till September. Very desirable for the rockery and also as a border plant. 30c. each; per doz., \$2.50; \$18.00 per 100.

OENOTHERA (Evening Primrose)

The evening Primroses are elegant subjects for growing in an exposed sunny position, either in the border or on the rockery, blooming the greater part of the summer.
Missouriensis. Large golden-yellow. 1 foot. 30c. each; per doz., \$2.50; \$15.00 per 100.

PACHYSANDRA

An evergreen trailing plant, with thick, glossy foliage forming a dense mat; one of the finest ground covers for either sunny or shaded locations.

Terminalis. Green; 6 to 8 inches high; small flower spikes of a grayish white, in May and June. 25c. each; doz., \$2.50; \$15.00 per 100.

PARDANTHUS (Blackberry Lily)

Very pretty perennial with lily-like flowers of handsome appearance. Requires a rich soil and a sheltered situation in winter.
Chinensis. Flowers orange-colored, spotted with purple-brown; 18 inches to 2 feet; flowers in June. 30c. each; doz., \$3.00; \$20.00 per 100.

PENTSTEMON (Beard Tongue)

Most useful showy perennials, either for the border or rockery. They are perfectly hardy.

Barbatus Torreyi. Spikes of brilliant scarlet flowers; height, 3 to 4 ft.; June to August.

Digitalis. Large spikes of long, purple-white flowers with purple throats, during June and July; 2 to 3 feet.

Gloxinoides, Sensation. A beautiful strain bearing spikes of large Gloxinia like flowers in a great variety of bright colors, including rose, cherry, crimson, purple, lilac, etc. The plants grow 2 ft. high and bloom from early Summer till frost.

Multiflorus Roseus. A compact growing variety, not over 2½ feet in height; the flowers are produced freely from June to August and are of a pleasing shade of coral-pink. Price, 30c. each; doz., \$3.00; \$18.00 per 100.

PHYSALIS (Chinese Lantern Plant)

Francheti. An ornamental variety of the Winter Cherry, forming dense bushes, about 2 feet high, producing freely its bright orange scarlet lantern-like fruits; highly interesting. 30c. each; per doz., \$2.50; \$15.00 per 100.

PHYSOSTEGIA (False Dragon-Head)

One of the most beautiful of our midsummer flowering perennials, forming dense bushes 4 to 6 feet high, bearing spikes of delicate tubular flowers, not unlike a gigantic heather.

Virginica. Bright but soft pink.

— *Alba*. Pure white; very fine.

Price, 30c. each; doz., \$2.50; \$18.00 per 100.

PINKS, HARDY GARDEN (Double)

These old-fashioned favorites, bearing their clove-scented flowers during the spring and early summer, are splendid cut blooms.

Elsie. Bright rose with maroon center.

Essex Witch. Delicate pink, finely fringed.

White Reserve. An everblooming variety, very double and pure white.

Price, 30c. each; doz., \$2.50; \$15.00 per 100.

NEW PERPETUAL FLOWERING HARDY PINKS (Dianthus Allwoodi)

This is a most important addition to worth while perennials. They are perfectly hardy and flower continuously from early Spring until late in the Autumn. The flowers are much larger than the old type of Hardy Pinks and are borne on long stems suitable for cutting; deliciously clove scented.

Harold. Large double white, of symmetrical form.

Jean. Pure white with purple center.

Mary. Pale rose-pink with light maroon center.

Robert. Delicate shade of old rose with light maroon center.

Good thrifty young plants of the above varieties. 50c. each; per doz., \$5.00.



Oriental Poppy

ORIENTAL POPPIES (Papaver Orientale)

These are the royal representatives of this popular genus, growing about 3 feet high and far surpassing in magnificence of bloom all the other types. For a display of brilliant coloring nothing equals them during their time of flowering, May and June, whether planted singly or in masses. They are easy of culture, almost any kind of soil suits them, but they do best in a rich deep loam. Plant them in the fall or early spring before May 1st; give them water during dry spells the first season, and mulch with leaves or stable litter in the fall; treated in this way, they will increase in size and consequently freedom of bloom for years to come. After they have finished flowering the plants die back, but appear again in September, or as soon as the weather gets cool; during this resting period care should be taken when cultivating the beds that the roots are not disturbed.

Goliath. One of the most effective; flowers of a rich scarlet; the largest flowered of this class.

Mrs. Perry. A soft shade of salmon rose; a beautiful large flower. This variety should be in every garden.

Perry's White. Pure satiny white with a bold crimson blotch at the base of each petal.

Orientalis (The Type). Brilliant scarlet with a black centre. Price, 35c. each; doz., \$3.50; \$18.00 per 100.

ICELAND POPPIES (Papaver Nudicaule)

The graceful foliage is surmounted with a mass of stems a foot high, which terminate in a beautiful cup-shaped flower. Flowers the entire summer.

Orange, Yellow, White; each color separate. Price, 30c. each; doz., \$2.50; \$18.00 per 100.

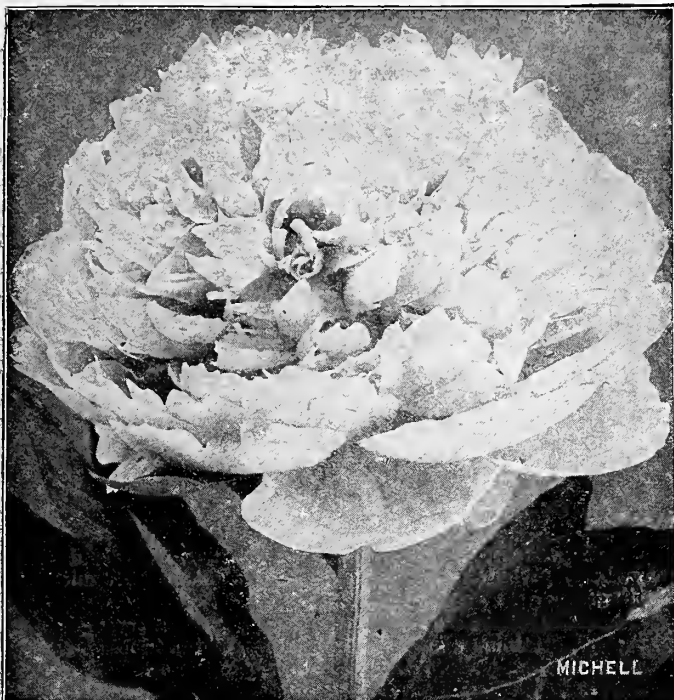

Paeony

No disease or insect ever troubles these plants. They delight in a sunny location and in deep rich soil. After planting, water regularly until you feel they are established and always take care to see that the crown or top of root is not more than 1 to 2 inches below the surface when covered. The roots are perfectly hardy and once planted remain for years, increasing in size. Roots can be delivered beginning in April or in the autumn beginning in September.

Asa Gray. Midseason; center flesh pink, dotted car-Each Doz.
mine, guards salmon; large full bloom \$0.75 \$7.50

MICHELL'S SUPERB HARDY PHLOXES

Our list of these is larger than what we offer here, and we shall be pleased to submit same on request.

Baron von Dedem. Deep pink, suffused orange; immense trusses.
Beacon. Brilliant cherry-red; a new variety and one of the best.
35c. each; per doz., \$3.50; \$20.00 per 100.

Elizabeth Campbell. Bright salmon-pink, with lighter shadings and dark red eye. 50c each; per doz., \$5.00.

Eugene Danzavilliers. Delicate lavender; a very attractive and decorative color; immense flowers. The peer of its color.

Europa. Blush white, with a large deep pink centre; the flower truss is very large, while the florets are also of gigantic size.

Frau Anton Buchner. Very large pure white flower truss, with gigantic individual florets; very dwarf.

Jules Sandeau. Dwarf; very large flowering; pure pink; extra fine variety. 35c. each; per doz., \$3.50; \$20.00 per 100.

L'esperance. Light lavender-pink with white center.

Montagnard. Dark purple claret; large spikes and flowers. 35c. each; per doz., \$3.50; \$20.00 per 100.

Mrs. Jenkins. The best pure white.

Rheinlander. Deep salmon pink, with a distinct bright red eye.

Rheinstrom. A splendid new phlox with gigantic flowers of a bright pink. Quite tall; continues in bloom till frost.

Riverton Jewel. Lovely shade of mauve-rose with brilliant carmine-red eye.

Rosamundi. Immense trusses of beautiful soft rose colored flowers. 35c. each; per doz., \$3.50; \$20.00 per 100.

Selma. Pale rose with cherry-red eye, one of the best.

Thor. Deep salmon pink, suffused with scarlet; a white halo surrounds the aniline red eye. 35c. each; per doz., \$3.50; \$20.00 per 100.

Von Lassburg. The queen of all clear white phloxes; trusses and single flowers are immense in size; rather dwarf.

W. C. Egan. One of the prettiest in our entire collection, the color being a pale lilac with an intense solferino-red eye.

Boule De Neige. Midseason; milk white, sulphur centre, prominently flecked crimson.....	Each	Doz
	\$0.60	\$6.50
Dr. Bretonneau. Lilac rose with cream white centre, flecked crimson. Midseason; fragrant.....	.60	6.50
Duchesse de Nemours. Pure white, with a sulphur-white centre; very early; fragrant.....	.60	6.50
Edulis Superba. Beautiful shaped flower of a bright mauve pink color, with narrow edges of lilac. One of the best early sorts and very fragrant.....	.75	7.50
Faust. Delicate flesh pink, with salmon centre. Mid-season.....	1.00
Felix Crousse. The ideal self-colored bright red Paeony.....	1.00	10.00
Festiva Maxima. Beautifully shaped flower, 7 to 8 inches in diameter. Pure white, splashed red; late...	.75	7.50
Floral Treasure. Large, delicate shell pink; fragrant rose type; midseason; blooms freely.....	.60	6.50
Fragrans. Solferino-red; late and good cut flower; fragrant.....	.75	7.50
Humei. Cherry-pink with silver tips; late, with cinnamon fragrance.....	.60	6.50
La Perle. Very large; globular; deep lilac white, bluish centre, prominently flecked carmine; fragrant.....	.60	6.50
L'indispensable. Perfect shaped flower of a delicate creamy color, shaded pink. Mid-season.....	.75	7.50
Marie Lemoine. Delicate rose white, with a creamy centre, very late and fragrant.....	.75	7.50
Meissonier. Guard petals brilliant purple red, centre deep crimson.....	.75	7.50
Ne Plus Ultra. Fine bright pink; early and free.....	.60	6.50
Purpurea Superba. Carmine-rose; midseason.....	.60	6.50
Queen Victoria. Pure white with creamy-white centre.....	.50	5.00
Rose D'Amour. Hydrangea-pink; midseason; fragrant.....	.60	6.50
Solfatere. Sulphur-white; midseason, fragrant.....	.60	6.50
Triomphe De L'Exposition De Lille. Pale hydrangea-pink, fragrant, midseason.....	.75	7.50
Van Dyck. Mauve, shading to clear pink; midseason; fragrant.....	.60	6.50

PAEONIES TO COLOR

	Each	Doz.	100
Double Pink	\$0.35	\$3.50	\$25.00
Double Red35	3.50	25.00
Double White35	3.50	25.00

Price of all varieties Hardy Phloxes, except where noted, extra strong roots which will flower the first season, 30c. each; doz., \$2.50; \$15.00 per 100.

PHLOX SUFFRUTICOSA

These differ from the others, in that the foliage and stem are deep green and glossy, and they begin to blossom in June and remain in bloom until October.

Miss Lingard.
Pure white, with a lilac eye; very early. 30c. each; doz., \$2.50; \$15.00 per 100.

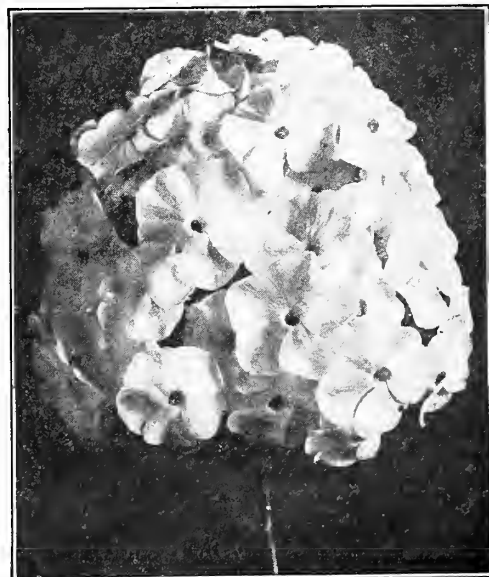

Hardy Phlox, Mrs. Jenkins

MICHELL'S HARDY PERENNIAL PLANTS

PHLOX SUBULATA

Alba. (*Moss Pink*). Moss evergreen-like foliage, tucking close to the ground and covered completely with white star-like flowers in May.

Lilacina. A beautiful shade of lilac.

Rosea. The same as above but with pure pink flowers.

Price of any of the above Phlox, 30c. each; doz., \$2.50; \$15.00 per 100.

MISCELLANEOUS VARIETIES OF PHLOX

Amoena. A beautiful plant, with soft rose-colored flowers; one of the best for rockeries or borders; 4 inches high; April-May.

Divaricata Canadensis. A patch of these makes a spring show hard to describe. The large heads of fragrant lavender flowers appear the latter part of April and in May.

Price, 30c. each; doz., \$2.50; \$15.00 per 100.

PLATYCODON

(Balloon Flower or Japanese Bell Flower)

The Platycodons are closely allied to the Campanulas, and form neat, branched bushes of upright habit.

Mrs. Ely says of them: "Do best if planted in early spring. They grow from 2 to 2½ feet high, and after the third season each plant will have from ten to twelve stalks covered with the lovely blue or white blossoms for nearly a month, beginning about July 10th. They are also free from attacks of insects, and if planted in good soil and well covered in late autumn with a litter of leaves or stable manure, will be found to be quite hardy."

Grandiflorum. Deep blue cupped, star-shaped flowers.

— **Album.** A white-flowered form of the above.

Price, 30c. each; doz., \$2.50; \$15.00 per 100.

PLUMBAGO (Lead-Wort)

Larpetae. One of the most desirable border and rock plants; it is of dwarf, spreading habit, growing 6 to 8 inches high, covered with deep blue flowers during the summer and fall months. 30c. each; doz., \$2.50; \$15.00 per 100.



Primula Veris

PRIMULA (Hardy Primrose)

One of the first of the early spring flowers. They delight in a rich soil, preferably in a semi-shaded location. Some of the varieties are richly colored, and are worthy of a place in every hardy garden. As a hardy border edging, as well as for rockery planting, it can be highly recommended.

Veris (*English Cowslip*). A mixture comprising the various shades of red and yellow; a splendid plant for the spring blooming garden.

Vulgaris (*English Primrose*). Beautiful light canary yellow; long flower stems with large trusses.

Price, 30c. each; doz., \$2.50; \$15.00 per 100.

PYRETHRUM (Giant Daisy)

Uliginosum. Grows 3 to 4 feet high and is covered with large white Daisy-like flowers, 3 inches in diameter, from July to September. 30c. each; \$2.50 per doz.; per 100, \$18.00.

PYRETHRUM HYBRIDUM

A good old-fashioned perennial resembling colored daisies, blooming in June. They will succeed in any good garden soil in a sunny position and do best when left undisturbed for 2 or 3 years, but they should be given an annual top dressing of well rotted manure.

Single Flowering. Mixed colors only, ranging from pure white to dark red. 30c. each; per doz., \$2.50; \$18.00 per 100.

RANUNCULUS (Crowfoot Buttercup)

Acris Fl. Pl. A double flowered form of our common buttercup; 2 feet; May and June.

Repens Fl. Pl. (*Bachelor's Buttons*). A pretty double flowering, bright golden buttercup, bearing masses of flowers during May and June.

Price, 30c. each; doz., \$2.50; \$18.00 per 100.

RUDBECKIA (Cone-Flower)

Indispensable plants for the hardy border; grow and thrive anywhere, giving a wealth of bloom, which are well suited for cutting.

Golden Glow. A well-known popular plant; a strong, robust grower, attaining a height of 5 to 6 feet, and produces masses of double golden-yellow, Cactus Dahlia-like flowers from July to September.

Newmani. Dark orange-yellow flowers, with deep purple cone, borne on stiff, wiry stems 3 feet high; flowers from July to September.

Nitida "Autumn Sun." An attractive single-flowering variety, growing 5 to 6 feet high, with long, broad petals of bright primrose-yellow; August to October.

Purpurea (*Giant Purple Cone-flower*). Flowers about 4 inches across, of a peculiar reddish-purple with a remarkably large cone-shaped centre of brown; forms bushy plants 3 feet high and blooms from July to October.

Price, 30c. each; doz., \$2.50; per 100, \$18.00.

SALVIA (Meadow-Sage)

Perennials with strikingly beautiful, orchid-like bloom, that make them welcome in the herbaceous border. Leaves are used in medicine and for the kitchen.

Azurea Grandiflora (*Rocky Mountain Sage*). Sky-blue flowers in greatest profusion during August and September; 6 feet.

Pitcheri. Similar to Azurea but of more branching habit and larger flowers of rich Gentian blue; 3 to 4 feet.

Virgata Nemorosa. An interesting plant for the hardy border; flower spikes bear many-flowered whorls of dark blue blossoms; the unexpanded buds are light violet blue, forming a pleasing color combination. It continues in flower for about six weeks during the early summer months; 18 inches.

Price, 30c. each; doz., \$2.50; \$18.00 per 100.

SAPONARIA (Soapwort)

Very ornamental, dwarf-growing perennials; very attractive for the rockery or as an edging plant. They are readily established in any soil and require little care.

Caucasica Fl. Pl. (*Double Flg. Bouncing Bet*). Double white flowers; 6 to 9 inches.

Ocymoides Splendens (*Rock Soapwort*). Dwarf creeping habit; rosy crimson flowers; 6 to 9 inches.

Price, 30c. each; doz., \$2.50; \$18.00 per 100.

SAXIFRAGA (Megasea)

Very useful plants, growing about 12 inches high, having broad, deep green foliage and thriving in any soil in almost any position. The pretty rose-pink flowers which appear very early in the spring, almost as soon as the frost is out of the ground, make this a valuable addition to the hardy garden. Makes an excellent plant for the front of the hardy border, or in the front of shrubbery. We offer strong plants at 30 cents each; per doz., \$2.50; \$18.00 per 100.

SCABIOSA

The hardy variety is even more wonderful and of greater beauty than the annual sort, commonly called Mourning Bride. The flowers are gigantic, measuring frequently 3 inches and more in diameter. It delights in a sunny position, and is a cut flower few perennials can equal. It lasts a long while in water; the average height is about 2½ feet. Very free flowering.

Caucasica (Blue Bonnet). A delicate shade of lavender blue, starting in flower in June and lasting well through the summer.

Caucasica Alba. White. Like the above, except the color.
Price, 30c. each; doz., \$2.50; \$18.00 per 100.



Sedum Spectabile, Brilliant

SEDUM (Stonecrop) DWARF VARIETIES

Suitable for the rockery and covering of graves, etc.

Acre (Golden Moss). Much used for covering graves; has green foliage and bright yellow flowers.

Album. Green foliage, white flowers.

Sieboldi. Round succulent glaucous foliage with bright pink flowers during August and September.

Stahli. A species with compact crimson foliage in the Autumn.

ERECT GROWING VARIETIES

Useful and pretty plants for the border, producing their interesting flowers during the late Summer and Fall.

Maximum Atropurpureum. Very desirable on account of its dark bronzy purple foliage; 15 inches.

Spectabile. One of the prettiest erect growing species, growing 18 inches high with broad light green foliage and immense heads of showy rose colored flowers in September and October.

Spectabile "Brilliant." A rich colored form of the above, being a bright amaranth red.

Prices of any of the above varieties. 30c. each; doz., \$2.50; \$18.00 per 100.

SENECIO (Groundsel)

Pulcher. Forms a neat tuft of foliage from which springs up from July to October, a succession of 2 feet high stems, with clusters of brilliant, rosy purple flowers, of good size. 30c. each; per doz., \$2.50; \$18.00 per 100.

SOLIDAGO (Golden Rod)

The Golden Rod in a cultivated form is one of the best hardy garden plants. We have discarded all other varieties except those listed below, as from observation we believe they fill every want for this plant.

Golden Wings. The finest of the Golden Rods; very showy; 5 feet high, with immense panicles of bright golden yellow flowers from July to September.

Virgaurea Compacta. Deep yellow flowers in August and September; very dwarf, only about 15 inches in height.

Price, 30c. each; doz., \$2.50; \$18.00 per 100.

SPIRAEA (Goat's Beard, Meadow Sweet)

Elegant border plants with feathery plumes of flowers and neat, attractive foliage; succeed best in a half-shaded location in rich, moist soil.

Filipendula (Dropwort). Numerous corymbs of white flowers on stems 15 inches high, during June and July; pretty fern-like foliage.

Filipendula Fl. Pl. A double flowering form of the above.

Palmata (Crimson Meadow Sweet). One of the most beautiful hardy plants; the deep purple red of the stems and branches passing into the crimson purple of the broad corymbs of flowers, which are produced very freely during June and July; 3 feet.

Ulmaria Fl. Pl. (Meadow Sweet). Double white flowers during July and August; 3 feet.

Price, 35c. each; doz., \$3.50.

STATICE (Sea Lavender)

Very ornamental genus of easy culture, but prefer a rather deep, loose soil. From the delicate nature of the flower panicles, the species are better suited to rockwork and isolated positions, than for mixing in a crowded border. Useful for cut blooms, especially for mixing with other flowers. July-August.

Latifolia (Great Sea Lavender). Handsome plants with heads of dark blue flowers; invaluable for cutting, the flowers when dried, lasting for months. 1 to 2 feet.

Eximia Fl. Alba (White Sea Lavender). Beautiful heads of light and graceful white flowers. Useful for table decoration. 1 foot.
Price, 30c. each; doz., \$2.50; \$18.00 per 100.



Single Sweet William

SWEET WILLIAM (Dianthus Barbatus)

This plant occupies a foremost position, producing, early in spring, quantities of bloom which make a grand effect, for just when they are in flower it is generally too soon for other perennials. For wild garden effect, Sweet Williams occupy first place.

Mitchell's Prize Mixture. In all colors.

Pink Beauty (Sometimes called Newport Pink). A splendid shade of salmon with immense flower trusses. When massed it is a striking feature of the perennial garden; an extra fine novelty.

Price of Sweet Williams, 25c. each; doz., \$2.50; \$15.00 per 100.

MICHELL'S HARDY PERENNIAL PLANTS

STOKESIA (Cornflower Aster)

The flower has the appearance of combining a giant cornflower and an aster. Plants are 18 inches high and are of spreading habit, blooming from June until frost. Succeeds in most any location.

Cyanea. Very light blue. | *Cyanea Alba*. Pure white.
Price of the above, 30c. each; doz., \$2.50; \$15.00 per 100.

TANACETUM

Vulgare (Tansy). Golden yellow flowers and beautiful sprays of fern-like foliage. 3 feet. June to August. 30c. each; doz., \$2.50; \$18.00 per 100.

THALICTRUM (Meadow Rue)

Very graceful, pretty flowered plants, with finely cut foliage; great favorites for planting in the hardy border; the dwarf varieties also being effective and useful in the rockery.

Adiantifolium. A beautiful variety, with foliage like the Maiden Hair Fern and miniature white flowers in June and July; 1½ to 2 feet.

Glaucum. Finely cut glaucous foliage; bronzy-yellow flowers in June; 2 feet.

30c. each; per doz., \$2.50; \$18.00 per 100.

THERMOPSIS

Caroliniana. A showy, tall-growing plant, attaining a height of 3 feet, producing long spikes of yellow flowers in June and July. 30c. each; per doz., \$2.50; \$18.00 per 100.

Tradescantia (Spider Wort)

Virginica. Produces a succession of blue flowers all summer; 1½ to 2½ feet.

Virginica Alba. A white flowered form.

30c. each; per doz., \$2.50; \$15.00 per 100.



Thalictrum

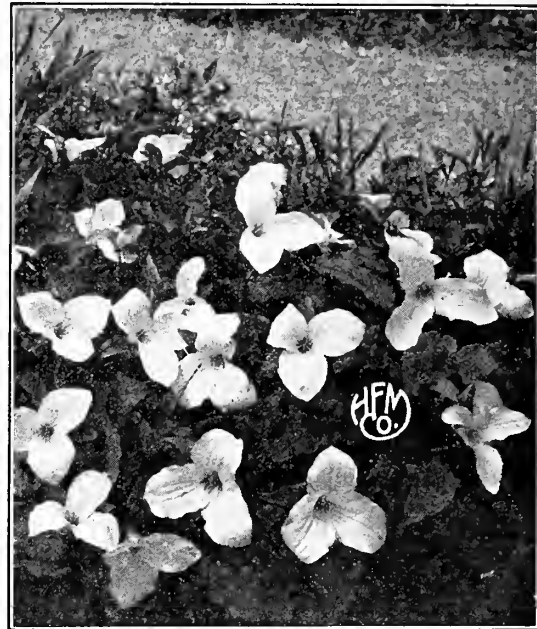

Trillium

TRILLIUM

(Wood Lily, or Wake Robin)

Excellent plants for shady positions in the hardy border, or in a sub-aquatic position, flowering in early spring; 12 to 18 inches.

Erectum. Broad foliage with dark purple flowers.

Grandiflorum. The largest white; probably the handsomest.

20c. each; per doz., \$2.00; \$12.00 per 100.

TRITOMA

(Red-hot Poker, Flame Flower or Torch Lily)

Pfizerii (The Everblooming Flame Flower). The early, free and continuous blooming qualities of this variety have made it one of the great bedding

plants, and when we consider that there are few flowering plants which are suitable for massing under our severe climatic conditions, it is little wonder that such an elegant subject should become so popular. Succeeds in any ordinary garden soil, but responds quickly to liberal treatment; hardy if given protection, but the most satisfactory method of wintering is to bury the roots in sand in a cool cellar. In bloom from August to October, with spikes 3 to 4 feet high, and heads of bloom of a rich orange-scarlet, producing a grand effect either planted singly in the border or in masses. 30c. each; per doz., \$2.50; \$18.00 per 100.

TROLLIUS (Globe Flower)

Desirable free-flowering plants, producing their giant Buttercup-like blossoms on stems 1 to 2 feet high from May until August; succeed admirably in the border in a half-shady position, in well drained, preferably light soil.

Goldquelle. Rich golden yellow.

Japanese Excelsior. A beautiful variety, with deep orange flowers.

35c. each; doz., \$3.50; \$25.00 per 100.

TUNICA

Saxifraga. A pretty tufted plant with light pink flowers, produced all summer; useful either for the rockery or the border. 30c. each; per doz., \$2.50; \$18.00 per 100.

VALERIANA (Valerian)

Coccinea. Showy heads of reddish flowers; June to October; 2 feet.

— *Alba*. A white-flowered form.

Officinalis (Hardy Garden Heliotrope). Produces showy heads of rose-tinted white flowers during June and July, with delicious heliotrope odor, 3 to 4 feet.

Price, 30c. each; per doz., \$2.50; \$15.00 per 100.

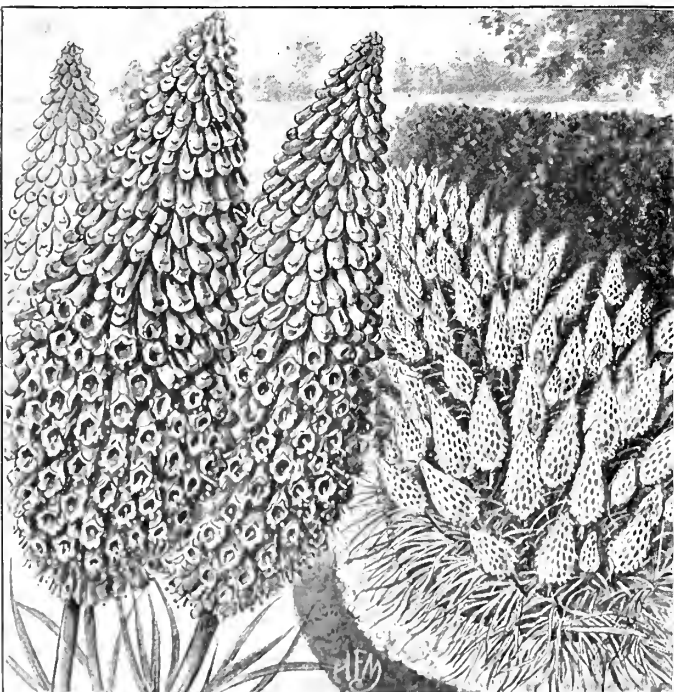

Tritoma, Pfizerii

See pages 110 to 115 for List of Hardy Roses.

VERBASCUM (Mullein)

Phoeniceum. A distinct and valuable species, with purple and pink flowers; 2 feet; June—July. 30c. each; doz., \$2.50; \$18.00 per 100.

VERONICA (Speedwell)

A large and much cultivated group of blue-flowered perennials, great favorites in the hardy garden. The taller forms are very pretty border plants, while the more dwarf spreading forms are well adapted to the rockery. Unexcelled for cutting purposes.

Amethystina. Amethyst-blue flowers on short spikes; one of the best; 2 feet; May to June.

Incana. White, woolly plant, tufted, with pale blue flowers; has a good appearance both in and out of bloom; useful in the rockery, border or geometrical garden; 1 foot to 18 inches; July to August.

Longifolia Subsessilis (Japanese Speedwell). This is destined to create as much furore in the flower world as did the Golden Glow. It is the handsomest blue-flowered plant we know of, growing to a height of two feet and completely studded with its spikes of blue flowers. Its flowers are fine for cutting. It is perfectly hardy and increases in strength and in beauty each succeeding year. It makes the best blue-flowered, hardy border plant obtainable; 2 feet; August to October.

Spicata. Regarded as one of the better border Speedwells, thriving in an open soil away from shade; clear blue flowers with purple stamens. 18 inches; June to August.

Price of the above, 30c. each; doz., \$2.50; \$18.00 per 100.

VINCA

(Periwinkle or Trailing Myrtle)

It is often a perplexing problem to find the plant that will do well in a dense shade; right there is where Vincas of the hardy class should be employed, also in lawn plantings under trees, in woodlands and on spots it is desired to cover where no grass will grow. It is valuable for planting on cemetery lots by reason of its dwarf creeping habit. The foliage is green all winter.

Minor. Green foliage, lavender flowers. Extra strong plants. 20c. each; doz., \$1.50; \$10.00 per 100.

Aurea. Identical in habit and value with the Minor type, except that the foliage is green, margined yellow. It is fast becoming very popular by reason of the brilliant show it makes. 30c. each; doz., \$2.50; \$15.00 per 100.



Veronica Longifolia Subsessilis

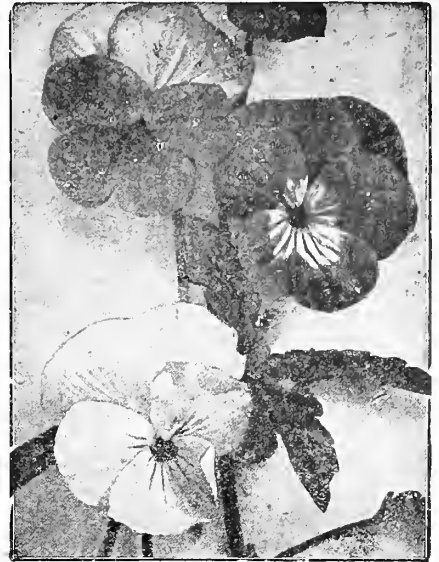

Viola Cornuta

Violas, or Tufted Pansies (Viola Cornuta)

The improved forms of Viola Cornuta are one of the important bedding plants of Europe, and are rapidly growing in favor here. They flower continuously for nearly eight months in the year, and while their flowers are not so large as those of the Pansy, their bright colors and free-flowering qualities make them welcome additions to any garden.

Blue Perfection. Deep purplish-blue.

Lutea Splendens. Rich golden yellow.

White Perfection. A fine white. 20c. each; per doz., \$1.50; \$10.00 per 100.

HARDY VIOLET

Double Russian. This is the hardy old-fashioned double blue violet admired by everyone, producing in early spring, large quantities of delightfully fragrant flowers. 25c. each; per doz., \$2.50; \$15.00 per 100.

WALLFLOWERS

The old fragrant favorite; mixed colors, including yellow, brown, etc. 30c. each; per doz., \$2.50; \$18.00 per 100.

YUCCA (Adam's Needle)

This plant sets off to best advantage if used as individual specimens, either on the lawn or in the shrubbery border. The foliage is of an evergreen nature, is slender and pointed. The tall flower-spikes rise 4 to 5 feet above the plant and are decked with cream-white bell-shaped drooping flowers during July and August. A majestic plant, especially fine for producing tropical effects.

Filamentosa. White, with reflexed flower bells. Extra strong plants, 35c. each; doz., \$3.50; \$25.00 per 100.

MICHELL'S COLLECTIONS OF HARDY PERENNIALS

We offer customers who are not acquainted with the different sorts the following collections, at greatly reduced prices, all good, strong plants, which once established will, with little care, keep the garden gay with flowers from the time frost leaves the ground until late in the autumn.

These collections are according to our own selection at the prices named.

For Sunny, Shaded or Partially Shady Perennial Border.

Collection No.

1	12 Hardy Perennials in	12 distinct named species for . . .	\$2.50
2	25 Hardy Perennials in	25 distinct named species for . . .	5.00
3	50 Hardy Perennials in	50 distinct named species for . . .	8.00
4	100 Hardy Perennials in	100 distinct named species for . . .	15.00

When ordering give number and collection wanted and state if for sunny or partially shaded position.



Yucca Filamentosa

Vines play an important part in the landscape of the home. There are so many purposes they fill that we cannot recommend too highly their general use.

AKEBIA—Quinata. Quick-growing vine; small, fine-lobed, half-ever-green leaves, and purplish brown or chocolate-colored flowers, which have a delicious odor. This plant is highly desirable where a dense shade is not desired. Extra strong plants, 50c. each; doz., \$5.00.

AMPELOPSIS—Quinquefolia (*Virginia Creeper*). The large handsome, dark green leaves are deeply cut into five lobes. In the autumn the foliage turns a beautiful rich crimson; especially adapted to covering tree stumps and trunks. Extra strong plants, 40c. each; per doz., \$4.00.

AMPELOPSIS—Veitchii (*Boston Ivy*). The popular climber for brick and stone buildings and walls. The leaves are a beautiful deep green which in the autumn turn to a coppery red. Strong plants, 35c. each; per doz., \$3.50; \$25.00 per 100.

ARISTOLOCHIA—Sipho (*Dutchman's Pipe*). Handsome light green leaves, giving a quick, dense shade. The brown flowers are shaped like the bowl of a pipe. Large plants, \$1.00 each.

BIGNONIA (*Trumpet Vine*). These are strong-growing vines, with rich green foliage and trumpet-shaped flowers.

Radicans. Free flowering; dark red, throat shaded orange. Strong plants, 50c. each.

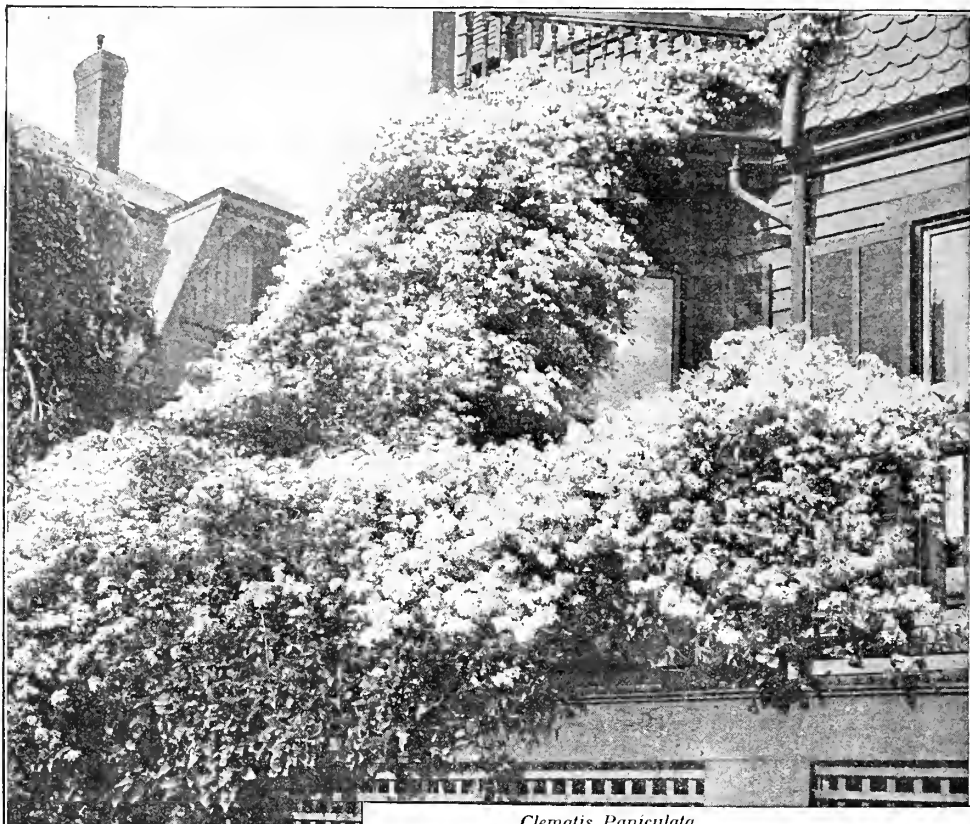

Clematis Paniculata

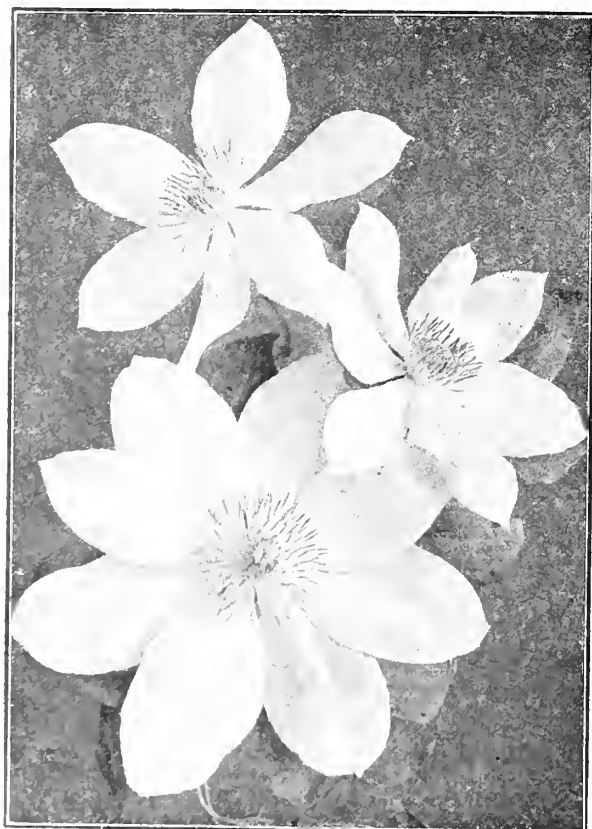

Large Flowering Clematis

CELASTRUS (*Bittersweet or Waxwort*)—**Scandens.** A vine of rapid growth. In the early summer it produces yellow flowers, which by autumn have turned to bright, orange-colored fruits, with red markings. Extra strong plants, 50c. each.

CLEMATIS. This family of Climbing Plants are probably more popular than any other. Some of the small flowering varieties are exceedingly fragrant. The large flowering types make a glorious effect on account of their gigantic blooms and striking appearance. All Clematis delight in plenty of sunlight, rich soil and plenty of water in dry weather. Great care should be exercised in planting the large-flowering varieties. During the process of transplanting, the stem is likely to get broken below the eye shoots, which would render the plant useless. To guard against this, place a few stakes around the plant to protect it after planting. In the winter put a covering of straw, long manure or leaves around the roots.

Crispa. This variety bears sweet-scented, lavender flowers. 50c. each; doz., \$5.00.

***Henryi.** Creamy white; large single flowers, borne in great profusion. Extra strong pot grown plants, \$1.00 each.

***Jackmanni.** Violet-purple; intensely colored, gigantic flower. Extra strong pot grown plants, \$1.00 each.

***Mme. Baron Veillard.** Large flowering; rich, reddish purple. Extra strong pot grown plants, \$1.00 each.

***Mad. Edouard Andre.** Velvety red. Flowers are well formed and of great substance; the blooms are gigantic. Extra strong pot grown plants \$1.00 each.

Paniculata (*Japanese Virgin's Bower*). A strong, luxuriant grower, with light green foliage. At the close of August innumerable star-like flowers cover the vine in a sheet of fragrant white. Strong plants, 30c. each; per doz., \$3.00; \$18.00 per 100. Extra strong plants, 50c. each; per doz., \$5.00; \$35.00 per 100.

Non-Warranty on Clematis

The large flowering types of Clematis those marked * are injured very easily often when being tied up, by animals and otherwise. We ship these plants in perfect order, after which we must respectfully ask our customers to relieve us of any responsibility in the matter of them growing or thriving.

CINNAMON VINE. Free growing climber, with small white flowers deliciously scented; makes a quick, dense shade. These can be mailed. Extra strong roots, 10c. each; per doz., \$1.00; \$7.00 per 100.

COBEA—Scandens (Annual). A beautiful blue, cup-shaped flowering annual climber; very desirable for lattice covering, etc. Extra strong plants, 4-in. pots, 30c. each; per doz., \$3.00.

EVONYMUS Kewensis. A new variety, with small dark green foliage; valuable as a rock plant or ground cover, as it does well under trees where grass will not grow. 30c each; doz., \$2.50; \$18.00 per 100.

— **Radicans.** Self-clinging vine, suitable for covering walls, stumps or rockeries, or wherever a vine of slow growing habit is desired; green foliage. 30c. each; doz., \$2.50; \$18.00 per 100.

— **Variiegata.** Leaves are variegated; otherwise like the above variety. 30c. each; doz., \$2.50; \$18.00 per 100.

— **Vegeta.** This plant is regarded far too little in importance as a strictly A-1 variety for climbing stone walls of buildings or otherwise; it ranks favorably with English Ivy, except that it is evergreen and does not winter kill or shed its foliage. The foliage is larger than that of the type *Radicans*, and the plant produces an orange-colored berry, which remains on the plant the most part of the winter. *Evonymus Vegeta* should be planted more extensively than it is. 30c. each; doz., \$2.50; \$18.00 per 100.

HONEYSUCKLE. This favorite requires very little comment or description, always yielding a wealth of fragrant bloom.

Chinese Evergreen. Yellow and white variegated flowers; very fragrant; blooms the entire season.

Halliana (Hall's Honeysuckle). Flowers pure white, turning to yellow; hardy evergreen; flowers from June until frost.

Red Coral or Scarlet Trumpet. Bright red, trumpet-shaped flowers. Blooms all summer. Extra strong plants only. 75c. each; doz., \$7.50.

Variiegated (Aurea Reticulata). Foliage beautifully mottled yellow and green; flowers white and yellow.

Price of any of the above Honeysuckles (except where noted), 4-in. pot-plants, 30c. each; doz., \$3.00; \$22.50 per 100. 6-in. pot-plants, 75c. each; doz., \$7.50; \$50.00 per 100.

HOP VINE (Japanese). A rapid grower, with dark green foliage, and bearing a profusion of seed-pods, suitable for many domestic purposes. Strong pot-plants, 30c. each; doz., \$2.50.

IVY (English). This is an invaluable plant for covering brick and stone walls and buildings. It rarely ever dies out and needs no attention. 4-in. pot-plants, 35c. each; per doz., \$3.50; \$25.00 per 100. 6-in. pot-plants, \$1.50 each; doz., \$15.00; 7-in. pots, \$2.00 each.

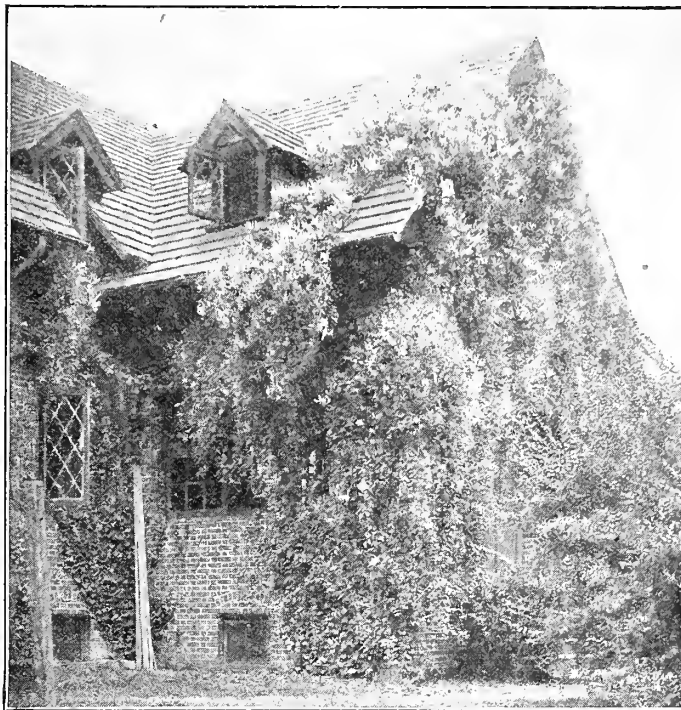

Polygonum Auberti

KUDZU (Pueraria). This vine grows a foot a day and makes a dense covering; exceedingly attractive. Towards the end of summer it produces small, rosy-purple flowers. 30c. each; doz., \$2.50; \$18.00 per 100.

LATHYRUS (Hardy Pea). This is a splendid plant for training on pillars, columns and similar places; it flowers during the greater part of the summer, and is a really splendid cut flower, lasting well, and very effective.

Latifolius. Rich red. 30c. each; doz., \$3.00.

— **Albus.** Pure white. 30c. each; doz., \$3.00.

— **Pink Beauty.** Beautiful rose pink. 30c. each; doz., \$3.00.

— **White Pearl.** Pure white, giant flower trusses. 50c. each; doz., \$5.00.

LYCIUM (Matrimony Vine)—Barbarum. A dense growing climber, somewhat shrubby in nature. In late summer the small purple flowers are followed by a crop of red berries, which remain until late winter. 35c. each; doz., \$4.00.

MADEIRA OR MEXICAN VINE. The tubers if planted deep and protected during the winter are hardy. The leaf is very deep green, and grows very dense; the flower is very small, white in color. Strong roots, 10c. each (single roots, mailed free); per doz., \$1.00; \$7.50 per 100 by express.

MOON VINE—Noctiflora (Annual). A pure white variety, blooming toward evening and in the forenoon; the flowers are frequently 6 inches in diameter. Extra strong plants, 30c. each; doz., \$2.75; \$17.50 per 100.

POLYGONUM

Auberti. For porches, lattice work, fences, pergolas and buildings. A useful vine which is perfectly hardy and free from disease or pests. It is quick growing, a small plant will make twenty-five to thirty feet of growth the first summer; snowy white flowers, borne in long clusters, which turn rose color with age. The foliage is clean looking and apart from its wonderful flower effect will please everyone. It will not cling to the wall, but will ramble over anything that will support it. Extra strong pot-grown plants, \$1.00 each.

WISTARIA. This flowers in the latitude of Philadelphia during May. A strong developed vine produces hundreds of flower panicles, while no foliage is visible until after the flower is faded. They thrive best in the sun, and with an application of cow manure once or twice a season they respond marvelously.

Chinensis (Chinese Wistaria). Pale blue; somewhat fragrant. Extra strong plants, 75c. each.

Chinensis Alba. A beautiful white flowering form of the above. Extra strong plants, 75c. each.

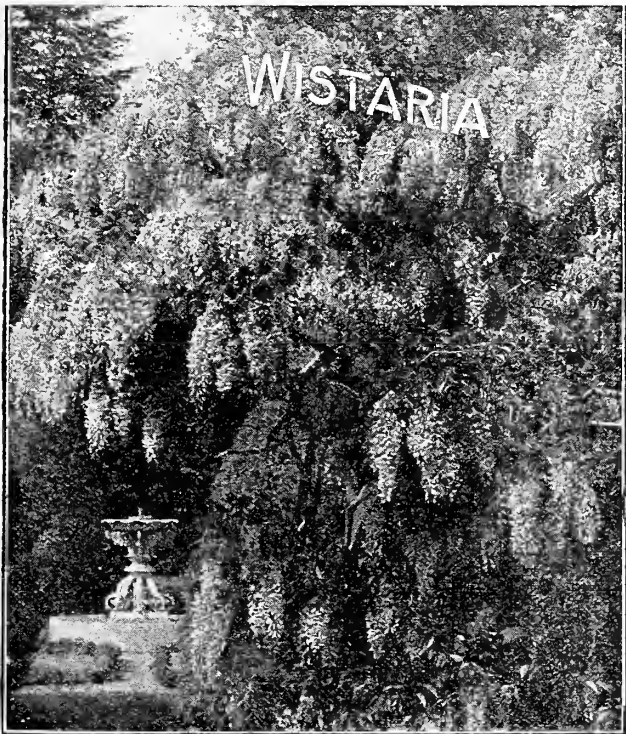

MICHELL'S CHOICE THRIFTY HEDGE PLANTS

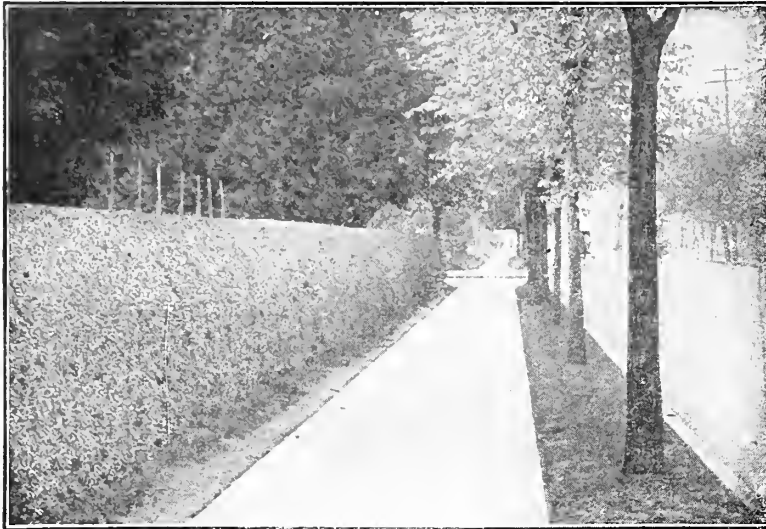

A privet hedge is much more attractive than the best fence

BERBERIS THUNBERGII (Japanese Barberry)

A good hardy plant of low dense growth. There is an air of grace and refinement to the Barberry Bush which is not embodied in any other hedge plant. It is a brilliant light green from early spring to winter. It should be regarded as a shrub, can be planted individually in lawn or border. The slender branches are prickly, with small thorns, and tend to make a defensive hedge that few animals will attempt to penetrate. In autumn the foliage is a bright crimson; when it falls a profusion of scarlet berries, which remain throughout the winter, are revealed on the branches.

Height	Each	Doz.	100
9-12 inches	\$.025	\$2.50 \$18.00
12-18 inches35	3.50 22.50

HYDRANGEA HORTENSIS

This class of Hydrangeas is planted extensively at many of the Atlantic seashore resorts and while it is perfectly hardy there it is not reliably hardy inland, even in the latitude of Philadelphia, unless planted at the side of a porch or building where it has some protection from the winter sun. Outside of these favored locations we recommend tub culture as the most satisfactory.

They should be left outside as late in the fall as possible, care being taken, however, to avoid sharp frosts which would injure the buds.

They should then be removed to a cool, light cellar where they will have a temperature of about 40 degrees and given only enough water to keep the roots from drying up and the branches from shriveling. The plants should be brought out in the early spring and well watered; provision should be made, however, to protect them from late frosts.

In some soils these will flower blue naturally and in other soils the flowers will be pink.

If you wish to have blue flowers when they naturally come pink this may be attained by incorporating with each bushel of soil one-half pound of lump alum broken into small pieces.

Otaksa. This is the old-fashioned favorite Japanese variety that usually flowers pink. It produces enormous flower trusses in great numbers. The plant increases in size and flowering ability each year and is the ideal variety for planting extensively at the seashore.

	Each	Doz.	Each
2½-in. Pot-plants	\$.025	\$2.50	7-in. Pot-plants.....\$1.50
4 -in. Pot-plants	.50	5.00	11-in. Tub-plants..... 5.00
6 -in. Pot-plants	1.00	10.00	

FRENCH VARIETIES

Baby Bimbenet. Large compact trusses of silvery-rose flowers.

General de Vibraye. Enormous flowers of a bright rose color.

Mme. Emile Moulliere. Pure white, with rich carmine eye.

Radiant. Brilliant rose pink; bright and showy.

Trophee. Brilliant carmine; very free flowering. One of the most desirable.

	Each	Doz.	Each	Doz.
2½-in. Pots	\$.025	\$2.50	6-in. Pots.....\$1.00 \$10.00
4 -in. Pots50	5.00	

BOXWOOD, Dwarf for Edging

We have a quantity of dwarf edging, nice bushy stock, for edging beds and paths. Boxwood grows into value and adds charm to the garden that no other plant can do.

	Each	Doz.	100
3- 5 inches high	\$0.35	\$3.50 \$25.00
6- 8 inches high50	5.00 40.00
10-12 inches high	1.00	10.00 75.00

CALIFORNIA PRIVET

Unlike a fence, which needs painting, repainting, etc., and then never looks well, this hedge is no further expense after planted, and it adds dignity and charm to any home, and increases the value of real estate. Being absolutely hardy, it increases in beauty with each successive year. Privet is somewhat of an Evergreen nature and looks attractive until real winter sets in. Plants should be set 12 inches apart in double rows, in zig-zag fashion, so that the plants are diagonally opposite each other; this practically places them 6 inches apart, which is desirable to get a quick, dense growth. Plant from October 15th till the ground freezes, and from March 15th to May 15th.

Height	Doz.	100	1000
1-yr. old, 18 to 24 inches	\$1.25	\$6.00 \$50.00
2-yr. old, 24 to 30 inches	1.50	8.00 70.00
2-yr. old, 30 to 36 inches	2.00	10.00 90.00

GOLDEN OR VARIEGATED PRIVET

Like the California variety, but each leaf is margined and blotched golden yellow, giving it, from a distance, a striking appearance. We recommend it especially for placing among shrubbery or for planting on the lawn; the contrast between the grass and golden foliage is beautiful.

Bushy Plants, 75c. each; doz., \$7.50.

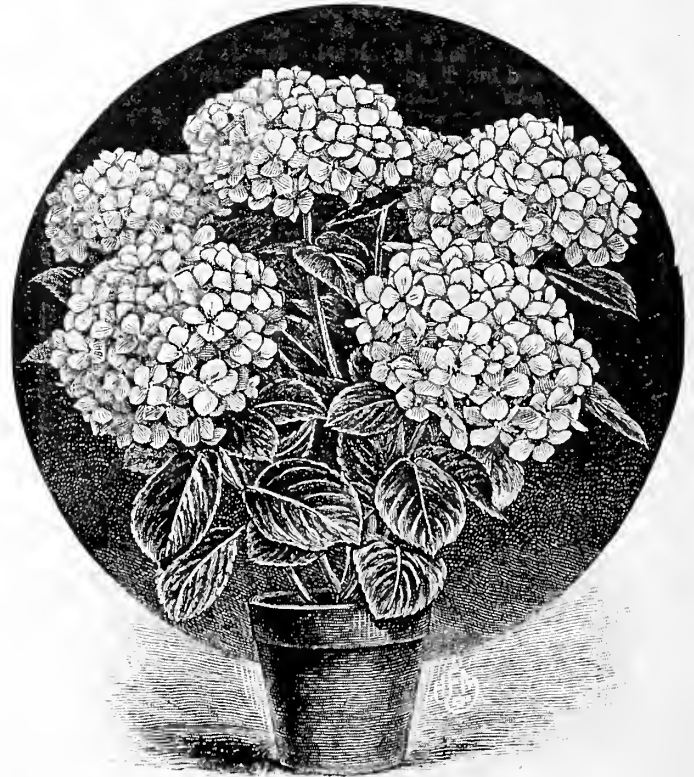

French Hydrangea

NOTE.—Except on southern orders or in cases where customers have greenhouses, we do not ship this class of hydrangeas out until May unless especially requested to do so. Where customers desire them shipped prior to our usual shipping date, we can forward but assume no responsibility in connection therewith.

These play an important part in the arrangement of the home grounds and should be planted extensively; they are ornamental even when not in flower. The varieties which bloom should be cut back after flowering to form new wood that will bloom the following year; we shall be glad to suggest assortments that will be attractive from spring until snow time.

Shipping Seasons are usually from March 15th to May 1st and from October 15th to November 15th.

ALTHEA (*Rose of Sharon*). These thrive almost anywhere, producing their bloom from July till September.

- **Alba Plena**. Pure white; double.
 - **Atropurpurea Plena**. Double purple.
 - **Duchess de Brabant**. Double; deep red.
 - **Lady Stanley**. Semi-double; pale pink, splashed with carmine.
 - **Totus Albus**. Single; pure white.
- Plants, 2 to 3 feet high, 75c. each; doz., \$7.50.

AMYGDALUS—Alba Flore Pleno (*Flowering Almond*). Erect, slender branches, which are covered in May with small, very double, fragrant white flowers. Strong plants, 2 to 3 feet, \$1.00 each.

— **Rosea Flore Pleno**. Identical with the above, but bearing pink flowers. Strong plants 2 to 3 feet, \$1.00 each.

BERBERIS—Thunbergii (*Japanese Barberry*). A good, hardy plant for lawn or border. The slender branches are prickly with small thorns, and tend to make a defensive hedge that few animals will attempt to penetrate. In autumn the foliage is a bright crimson; when it falls, a profusion of scarlet berries, which remain throughout the winter, are revealed on the branches.

Height	Each	Doz.	100
9-12 inches.....	\$0.25	\$2.50	\$18.00
12-18 inches.....	.35	3.50	22.50

BUDDLEIA—Variabilis

Magnifica. (*Butterfly Bush*). This is perhaps the most popular of our garden and hardy border shrubs. It flowers almost uninterruptedly from late in May until almost frost. The long panicles contain hundreds of miniature florets, of a beautiful lilac shade. There is considerable fragrance to them and they attract butterflies in great numbers, from which fact the shrub has earned its name. The bush grows

about 4 ft. high and contains hundreds of flower heads or spikes. After frost the bush should be cut back to the ground to insure new vigorous growth the following year. Strong pot plants, 30c. each; doz., \$3.00; \$20.00 per 100. Extra strong pot plants, 50c. each; doz., \$5.00;

1 year old field grown plants, \$1.00 each.

CALLICARPA PURPUREA (*Beauty Fruit*). A beautiful shrub growing about 3 feet high, with graceful branches that are covered in August with tiny pink tinted flowers. These are followed in late September by violet purple berries born in clusters from the axil of every leaf; these remain on the plant until the middle of the Winter. 75c. each; doz., \$7.50.

CALYCANTHUS—Floridus (*Sweet Shrub*). Chocolate-colored double flowers, with a peculiar agreeable odor. Blooms in June. 3 to 4 feet, 75c. each; doz., \$7.50.

CERCIS—Canadensis (*Judas Tree or Red Bush*). A tall, slender growing shrub, developing eventually into a large tree. Very early in the spring the leafless branches are covered with delicate deep pink flowers. 4 to 6 feet plants, \$1.00 each.

CHIONANTHUS—Virginica (*White Fringe*). In May and June the tree is covered with long, fluffy panicles of fine white bloom. Strong plants, 2 to 2½ feet, 75c. each; doz., \$7.50.

SPECIAL NOTICE ON GUARANTEE

We spare no effort to supply decorative shrubs of the best quality in first-class living condition. On account of the many causes beyond our control we regret we cannot guarantee this stock to live and establish itself, as that is usually entirely within the power of the buyer or planter. If customers desire us to guarantee decorative shrubs to live we will assume such guarantee at an advance of 25 per cent, over and above our usual prices, but not otherwise, and such guarantee will expire within 90 days from date of shipping.

CLETHRA—Alnifolia (*Sweet Pepper Bush*). Of low and dense growth; has numerous spikes of small white fragrant flowers appearing in July; desirable for moist places or along water edges. One of the prettiest of our native shrubs. 2 to 3 feet, 75c. each; doz., \$7.50.

CORNUS (*Dogwood*). This plant is so well known that it hardly needs description. The flowers appear before the foliage in May. In autumn it takes on a rich crimson shade.

— **Florida** (*White Flowered Dogwood*). Strong plants; 4 to 5 ft., \$1.50 each; doz., \$15.00.

— **Rubra** (*Pink Flowered Dogwood*). 3 to 4 ft., \$2.50 each.

— **Elegantissima** (*Variegated Dogwood*). A beautifully variegated shrub which should be planted more freely. Strong plants, 3 to 4 feet high, \$1.50 each; doz., \$15.00.

— **Lutea** (*Golden-Twigged Dogwood*). Bright yellow branches in Winter. Strong plants, 3 to 4 feet high, \$1.50 each; doz., \$15.00.

— **Sibirica** (*Siberian Dogwood*). Branches a bright, coral red which are quite ornamental for Winter effects. Strong plants, 3 to 4 feet high, 75c. each; doz., \$7.50.

CYTISUS—Laburnum (*Golden Chain*). A large shrub with shining green leaves and long drooping racemes of yellow flowers, which appear in the early summer. \$2.00 each.

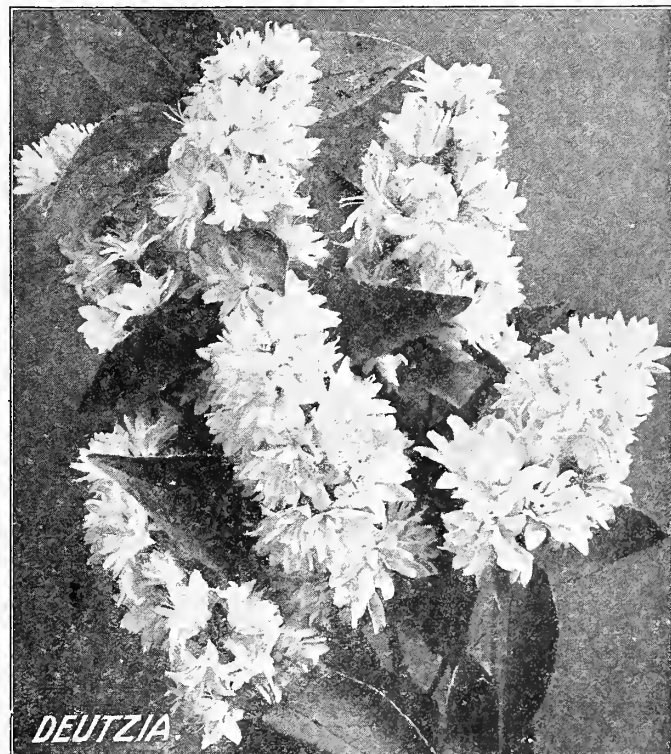
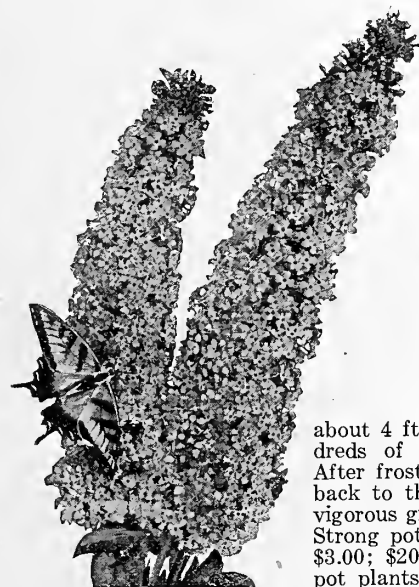

DEUTZIA. The Deutzias are among the most useful of our summer flowering shrubs. For planting either individually or in masses they are very attractive.

— **Candidissima Fl. pl.** Abundant racemes of double, pure white flowers in June; luxuriant foliage, and fine habit. 3 ft. plants.

— **Crenata Rosea Fl. pl.** Double flowering; white tinged pink. 3ft.

— **Gracilis**. Of dwarf, bushy habit; white flowers. 18 inches. Price of any of the above, 75c. each; doz., \$7.50.

— **Pride of Rochester**. The flowers, borne in large panicles, are pinkish white, with under-side of the petals rose. June. 75c. each; doz., \$7.50.

- EVONYMUS ALATA** (*Cork-barked Evonymus*). Small delicate flowers in late Spring are followed by attractive red berries in the Fall. Curious corky bark, brilliant Autumnal foliage. Best for individual planting. 18 to 24 inches, 75c. each; doz., \$7.50.
- **Japonica**. Beautiful deep green foliage; a splendid evergreen. 12 to 15 inch plants, \$1.00 each; doz., \$10.00.
- **Argentea Variegata**. A variety of the former, the leaves being beautifully variegated with silvery white. 5-inch pot grown plants, \$1.00 each.
- **Aurea Variegata**. Similar to the above with golden variegated foliage. 5-inch pot grown plants, \$1.00 each.
- EXOCHORDA GRANDIFLORA** (*Pearl Bush*). A medium sized shrub, producing white flowers in graceful clusters, early in the Spring; very graceful and fine for cut flowers. Strong plants 18 to 24 inches, 75c. each; per doz., \$7.50.
- FORSYTHIA** (*Golden Bells*). Bright golden yellow, star-shaped flowers burst into bloom just as winter is leaving and while the bush is otherwise bare.
- **Fortunei**. Erect growing with dark green foliage; strong plants, 4 ft., 75c. each; doz., \$7.50.
- **Intermedia**. April. Vigorous grower with slender, erect or arching branches. Considered by many as the best of the family. 75c. each; doz., \$7.50.
- **Suspensa**. Graceful, drooping tendency. Frequently planted on banks and slopes. Beautiful as specimens or in masses. 75c. each; doz., \$7.50.
- **Viridissima**. Erect shoots, spreading branches and excellent foliage that assumes a rich Autumnal tint and persists until early Winter. 75c. each; doz., \$7.50.



- HYDRANGEA—Arborescens Grandiflora Alba** (*Snowball Hydrangea*). The snow-white blooms are of the largest size, coming into flower early in June and lasting until late in August. Is more hardy than any other sort and especially suited for shaded places. 2 to 2½ ft., 75c. each; doz., \$7.50.
- **Paniculata Grandiflora**. The large panicles of white flowers are at their best during August; later they take on a reddish cast. These plants look fine used as single specimens on the lawn or grouped in large beds. Strong bush form, 2 ft. plants, 75c. each; per doz., \$7.50. Extra strong stock, 3 ft., \$1.25 each; per doz., \$12.00.
- **Paniculata Grandiflora** (*Standard or Tree Shaped*). These are fine, planted as individual specimens in the lawn or in the centre of beds, containing other plants. Stems 2 to 2½ feet long, with shapely heads, \$1.50 each.
- **Quercifolia** (*Oak-leaved Hydrangea*). A handsome spreading shrub with striking foliage, turning in Autumn to a beautiful red. The flowers are produced freely in August, in flat white clusters. Strong plants 18 to 24 inches, \$1.50 each.
- JASMINUM—Nudiflorum**. A fine shrub for sheltered positions, bearing fragrant yellow flowers very early in Spring. Hardy south of Philadelphia. 75c. each; doz., \$7.50.
- **Officinale** (*Common White Jessamine*). Vigorous grower with a profusion of white flowers; deliciously fragrant. 75c. each; doz., \$7.50.

- LONICERA—Fragrantissima** (*Honeysuckle*). March and April. Delightfully fragrant white flowers that come with the first breath of Spring. A broad, many-branched shrub. 75c. each; doz., \$7.50.
- **Morrowi**. An open bush with irregular branches. The foliage is dark green with small white flowers, which appear during May. During the late summer and early autumn the plant is covered with bright red berries. Plants, 3 feet, 75c. each; doz., \$7.50.
- **Ruprechtiana**. A free flowering variety producing pure white flowers during May and June, followed by red fruit. 75c. each; doz., \$7.50.
- MALUS** (*Crab*)—**Bechtel's Double Flowering**. Grows medium height, producing large double flowers of wonderful fragrance. 2 to 3 ft. high, \$2.00 each; 3 to 4 ft. high, \$3.00 each.
- PHILADELPHUS—Coronarius** (*Mock Orange*). Handsome foliage and beautiful, fragrant white flowers in May and June. 2 ft. plants, 75c. each; doz., \$7.50.
- **Grandiflorus**. A robust growing variety, bearing large white flowers. 3 ft. to 4 ft., 75c. each; doz., \$7.50.
- PYRUS—Japonica** (*Japan Quince*). This shrub is a beautiful sight when covered in the early spring with cherry-red flowers, about the size of an apple blossom. After the flowers fall, many of them set fruit, which is edible, making the finest Quince jelly or preserves. Extra strong plants, 2 ft., 75c. each; doz., \$7.50.
- RHUS—Typhina Laciniata** (*Dwarf Cut-leaved Sumac*). Low growth and fern-like foliage make this variety distinctive. Foliage is brilliantly colored in the fall months. 75c. each; doz., \$7.50.



Spirea, Van Houttei

- SPIREA—Anthony Waterer**. Of dwarf, dense habit, bearing a profusion of crimson flowers. 18 inches, 75c. each; doz., \$7.50.
- **Prunifolia** (*Bridal Wreath*). The pretty double white flowers are all along the almost leafless stem about May 1st, just as the leaves are budding. 3 feet, 75c. each; per doz., \$7.50.
- **Thunbergi**. One of the prettiest of the dwarf shrubs, with fine delicate foliage and a profusion of small white flowers in the early Spring. 12 to 18 inches, 75c. each; per doz., \$7.50.
- **Van Houttei**. The most beautiful of all white Spireas, flowering in May, when it is a complete fountain of white bloom. 3 to 4 feet, 75c. each; per doz., \$7.50.
- SYMPHORICARPUS—Racemosus** (*Snowberry*). Small red flowers are succeeded by many white berries, remaining on the plant through half the winter. Strong plants, 75c. each; doz., \$7.50.
- **Vulgaris** (*Red fruited or Indian Currant*). This is a well known shrub, bearing pink flowers followed by bright red fruit. 75c. each; doz., \$7.50.
- TAMARIX—Africana**. Strong, slender, upright growth, with panicles of feathery pink flowers in May. 3 to 4 feet, 75c. each; doz., \$7.50.
- **Hispidus Aestivalis**. A distinct variety, bearing delicate sprays of soft pink flowers in July and August, very light and feathery. 2 ft. to 3 ft., 75c. each; doz., \$7.50.



VIBURNUM OPULUS (*High Bush Cranberry*). One of the most popular shrubs, bearing clusters of white flowers in June, followed by bright scarlet berries in Autumn, which are very attractive throughout the Winter. Strong plants, 2 ft. to 3 ft., 75c. each; doz., \$7.50.

— **Opulus Sterilis** (*Snowball or Guelder Rose*). This is the popular white Snowball, filled with large globes of white flowers in May. Strong plants, 2 ft. to 3 ft., 75c. each; doz., \$7.50.

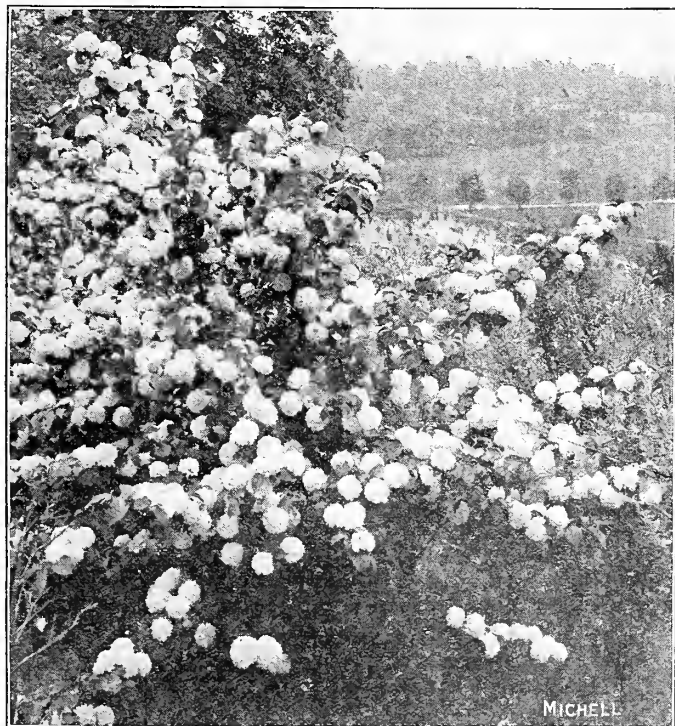

Viburnum Plicatum

VIBURNUM Plicatum (*Japanese Snowball*). A desirable shrub. Should be in ever garden or on the lawn; perfectly hardy; blooms in June. Extra fine plants, 2 to 3 feet, 75c. each; doz., \$7.50.

— **Tomentosum**. Distinct from all other varieties of Snowball, both in foliage and flower; the latter are more flat than those of the other varieties and followed by decorative red fruits, changing to black as they ripen. Strong plants, 2 to 3 feet, 75c. each.

SYRINGA (*Lilac*)—**Charles X**. A strong growing variety; bearing large trusses of reddish purple flowers. \$1.00 each.

— **Japonica**. A very desirable free flowering tree, bearing during June and July fragrant white flowers in large panicles. 75c. each; doz., \$7.50.

— **Marie Legraye**. A dwarf growing variety, producing immense trusses of beautiful creamy white flowers; one of the most popular single white sorts. \$1.00 each.

— **Vulgaris**. Common purple, sweet-scented lilac. 75c. each; doz., \$7.50.

— **Vulgaris Alba**. Pure white type of the above, but more fragrant. 75c. each; doz., \$7.50.

VITEX AGNUS CASTUS (*Chaste Tree*). A shrub or small tree, with strong aromatic odor; dense spikes of pale lilac flowers from July to September. Strong plants, 2 to 3 feet, 75c. each.

HOW TO CARE FOR SHRUBS

When received plant them to the depth they were when in the nursery; cut them back to within 18 inches from the ground, put a quantity of fertilizer such as bone meal or sheep manure around the roots, firm the soil about them well and water thoroughly two or three times a week until they are established. The flowering varieties should be planted in a sunny position. Each season after they have flowered, prune them back to ensure a wealth of flowers the following season.



WEIGELIA—**Candida**. Flowers abundantly in June and July; additional bloom is also shown during the autumn months. The tube-shaped flowers are pure white; fine for cutting. Plants, 4 feet, 75c. each; doz., \$7.50.

— **Eva Rathke**. Of erect form and vigorous habit. The deep carmine-red flowers are the best of the red-flowering sorts; 2 to 3 feet, 75c. each; doz., \$7.50.

— **Rosea**. Remarkably showy flower; numerous spreading branches and dark green leaves. The rose-colored blooms are produced in great abundance. 75c. each; doz., \$7.50.

— **Rosea nana variegata**. Silvery variegated leaves and pale pink flowers. 75c. each; doz., \$7.50.

Shipping seasons are usually from March 15th to May 1st, and from October 15th to November 15th.

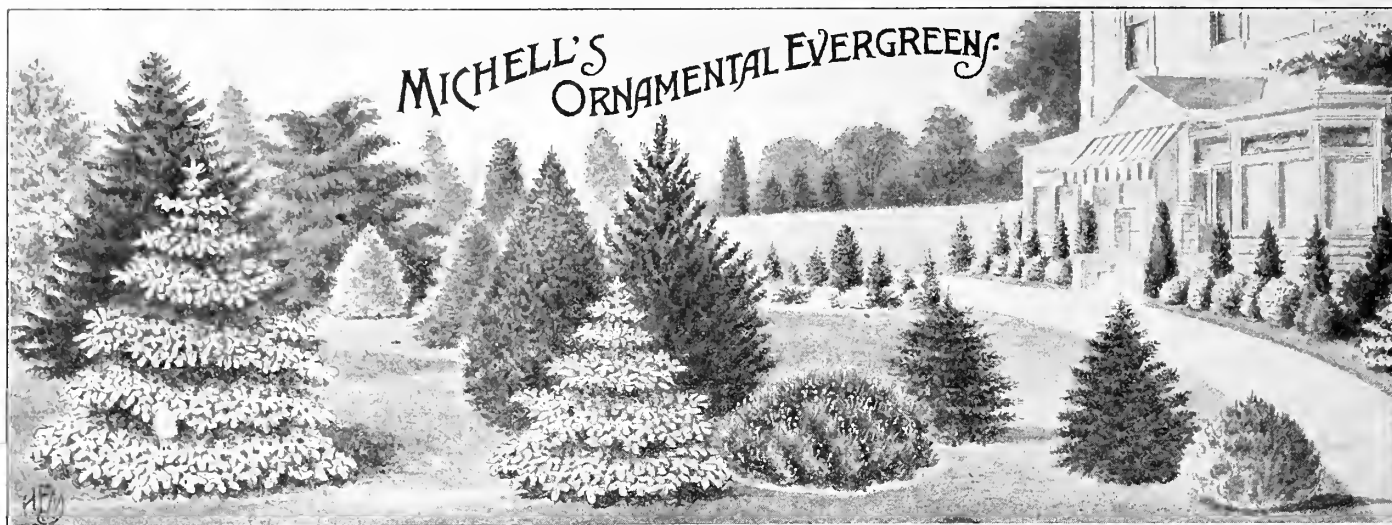

Evergreens offer a wide variety and brilliant diversity of color, every shade of green and blue foliage; then there are the rich, golden tints, the soft silvery grays and those varieties with the dainty white-tipped leaves.

Evergreens are much desired for specimen lawn trees; they are also extensively used for massing, shelter belts, screens and hedges. The taller varieties form perfect backgrounds for the showy flowering shrubs and trees of early spring, the berries of autumn, the bright bark and twigs of winter, or the light green, golden or silver-blue growth of smaller evergreens.

This list includes the varieties mostly in demand.
We can furnish all other sorts.

JUNIPERUS (*Juniper*). These possess remarkable vigor and thrive in bleak situations, in poor, stony soils and barren lands, in low and damp places at the seashore, in fact, most anywhere.

— **Excelsa Stricta** (*Greek Juniper*). Close growing, pyramidal form, with gray green foliage. Excellent in the formal garden. 12 to 15 inch, \$2.75; 15 to 18 inch, \$3.50.

— **Hibernica** (*Irish Juniper*). Very useful in formal planting, screenings for small yards and cemeteries. 1 to 2 feet, \$2.25; 2 to 3 feet, \$4.50.

— **Pfitzeriana**. A beautiful new form, with graceful dark green foliage. One of the most attractive of evergreens. 1½ to 2 feet, \$4.50; 2 to 3 feet, \$6.00.

PICEA (*Spruce*). Probably better known and more largely planted than any of the other evergreens; they are hardy, tall and rapid growers; reliable in almost any locality, living for many years. Suitable for planting as specimens, while some varieties are used for hedges and windbreaks.

— **Canadensis** (*Hemlock Spruce*). A rapid grower; very hardy and not particular as to soil. If trimmed, it becomes dense and bushy, making beautiful hedges. 2 to 3 feet, \$5.00; 3 to 4 feet, \$7.00.

— **Excelsa** (*Norway Spruce*). Rapid grower; does well in most soils. It is highly valued for shelters, windbreaks or hedges. 2 to 3 feet, \$3.00; 3 to 4 feet, \$4.00.

PINUS (*Pine*). These will endure a wide range of climatic conditions, being native in the lowlands or the mountains, and will withstand cold, bleak winds. Useful on lawns and on public grounds. They are in variety so that a suitable sort may be selected for almost any purpose.

— **Austriaca** (*Austrian Pine*). Tall, massive, with spreading limbs and long, stiff needles. Thrives along the coast, inland, and under city conditions. Handsome for specimen or open group planting. We offer an especially fine lot of these desirable trees. 3 to 4 feet, \$5.00.

— **Excelsa** (*Bhotan Pine*). Somewhat like the White Pine, having graceful branches, silvery gray green in color; very suitable for massing. 3 to 4 feet, \$5.00.

— **Mughus** (*Mugho Pine*). A low growing, broad spreading tree; in fact it is more of a large pine bush than a tree, and is very ornamental. 1 to 2 feet, \$5.00.

See Page 141 for Special Notice on Guarantee.

RETINOSPORA (*Cypress*). The many varieties vary considerably in their general appearance and nature of growth; all of them can be clipped occasionally to keep them within growing boundary. The shades of colors are numerous, so that an assortment of them makes a handsome effect.

— **Filifera** (*Thread Branched Retinospora*). Broad and bushy, with pendulous, dark green foliage of a thread-like nature. 1½ to 2 feet, \$4.50; 2 to 2½ feet, \$6.00.

— **Plumosa** (*Plume-like Cypress*). A splendid bushy variety with pyramidal outline, slender, graceful branches and light green leaves. 1½ to 2 feet, \$3.75; 2 to 2½ feet, \$4.50.

— **Plumosa aurea**. The most popular and generally useful of all the golden evergreens. Especially ornamental, the soft, plume-like golden foliage being particularly bright in spring. 12 to 18 inches, \$2.25; 2 to 3 feet, \$5.00; 3 to 4 feet, \$6.25; 4 to 5 feet, \$9.50.

TAXUS (*Yew*). These are a small growing evergreen, highly ornamental; effective in groups or bed plantings.

— **Cuspidata** (*Japanese Yew*). One of the hardiest of Yews. Upright, rather open growth, with rich green foliage; can be kept uniform and symmetrical by occasional shearing. 12 to 18 inch, \$3.50; 18 to 24 inch, \$5.00.

— **Cuspidata brevifolia**. The branches are spreading and the general aspect is less dense than the common Yew. Perfectly hardy. 12 to 15 inches, \$3.75; 15 to 18 inches, \$4.50.

THUYA (*Arborvitae*). These are chiefly of upright habit, not growing overly tall; exceedingly hardy; of a brilliant green all through the bleakest winter; splendid for back-grounds, windbreaks or garden fences.

— **Aurea** (*Golden Arborvitae*). Golden foliage retained well throughout the year. Attractive as a specimen, or to produce color contrasts in groups or beds. 18 inch, \$3.75; 24 inch, \$4.50.

— **Globosa** (*Globe Arborvitae*). Light green foliage of a grayish cast. The neat globular outline adapts this Arborvitae for formal plantings, tub and window box use, as well as in the foreground of Evergreen groups. 12 inch, \$3.00; 15 inch, \$3.50.

— **Occidentalis** (*American Arborvitae*). A well-known, popular evergreen for ornamental hedges; rapid growth. 2 to 3 feet, \$2.25; 3 to 4 feet, \$4.50; 5 to 6 feet, \$7.50.

— **Occidentalis pyramidalis** (*Pyramidal Arborvitae*). The most narrow, columnar-like evergreen; medium growth; very distinct light green, compact foliage. 2 to 3 feet, \$4.50; 3 to 4 feet, \$7.50.

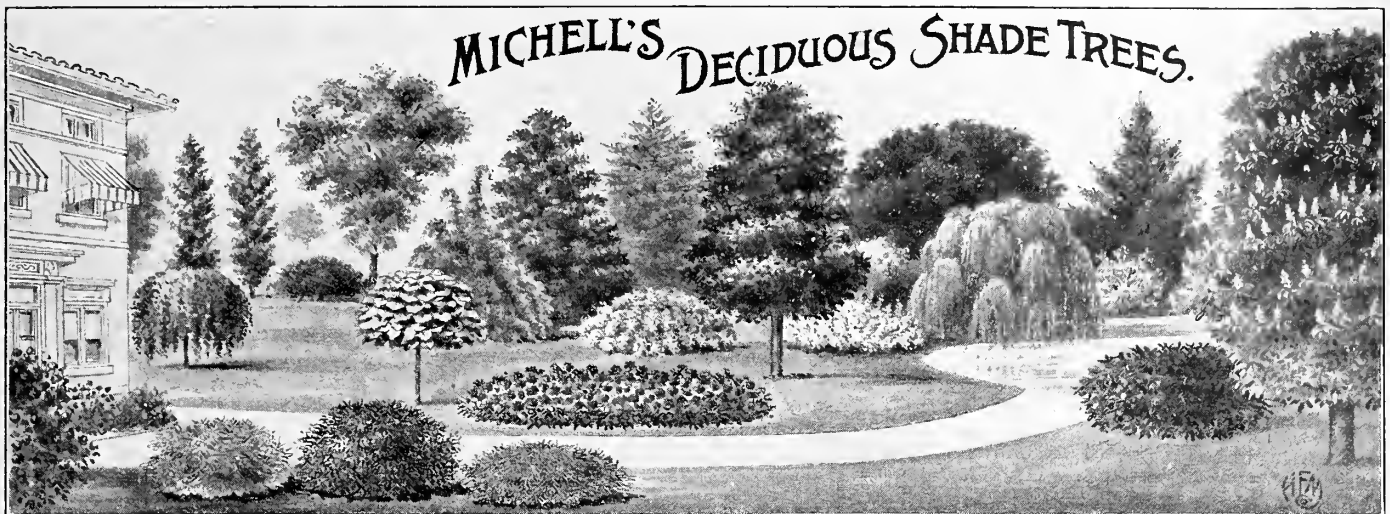

MICHELL'S DECIDUOUS SHADE TREES.

This list includes the varieties mostly in demand.
We can furnish all other sorts.

Beech, Purple (*Fagus sylvatica purpurea*). The foliage in spring is a deep purple, changing later to green. Should be closely pruned when transplanted. 4 to 5 feet, \$3.50.

Birch, Cut-Leaved Weeping (*Betula laba laciniata pendula*). Tall, slender, with graceful drooping branches, silvery-white bark and delicately cut foliage. 4 to 6 feet, \$2.00.

Crab, Betchel's Double Flowering (*Malus Ioensis Bechtelii*). The tree is of medium growth; the flowers are of immense size and of a beautiful pink color; highly fragrant. Very double. 2 to 3 feet, \$2.00; 3 to 4 feet, \$3.00.

Crab, Parkman's Flowering (*Malus Parkmanii*). Rose-colored buds open into little rosy-white flowers; these are succeeded by decorative fruits. The tree is of a rather spreading, irregular nature. 2 to 3 feet, \$2.00; 3 to 4 feet, \$3.00.

Dogwood (*Cornus*). See Page 137.

Elm, American (*Ulmus Americana*). One of the finest street shade trees in the world. 8 to 10 feet, \$2.50.

Horse Chestnut (*Aesculus hippocastanum*). The flowers are large, white spotted with purple and produced in large, compact spikes. A fine shade tree. 4 to 6 feet, \$3.00.

Larch, European (*Larix decidua*). A conifer with deciduous needle-like leaves; bright green very early in spring, and clear yellow in autumn. 3 to 4 feet, \$2.50.

Linden, American (*Tilia Americana*) (*Basswood*). The largest-growing Linden. Suitable for parks or streets. When in blossom, its yellow flowers are intensely fragrant. 8 to 9 feet, \$3.00; 10 to 11 feet, \$5.00.

Linden, European (*Tilia vulgaris europaea*). Leaves smaller and darker than those of the American Linden; forms a dense shade. 8 to 10 feet, \$4.00; 10 to 12 feet, \$5.00.

Magnolia Soulangeana. A low spreading tree, covered early in the spring before the leaves appear with large flowers, purple at the base and white in the upper half of the petals. 3 to 4 feet, \$10.00.

Maple, Norway (*Acer platanoides*). One of the finest park, street or lawn shade trees in America; of rounded form, compact habit and stout, vigorous growth. 8 to 10 feet, \$3.00; 10 to 12 feet, \$4.50; 12 to 13 feet, \$6.00.

Maple, Sugar (*Acer saccharum*). Its upright habit of growth, dense shade and adaptability to different soils have rendered it one of the most extensively used. The autumn effect of the foliage is particularly handsome. 8 to 10 feet, \$3.50; 10 to 12 feet, \$4.00.

Maple, Silver (*Acer dasycarpum*). Of rapid growth; extensively planted for ornament and shade. 8 to 10 feet, \$2.50; 10 to 12 feet, \$2.75.

Mountain Ash (*Sorbus aucuparia*). A handsome native tree; in autumn and early winter it is clothed with large clusters of red berries. 6 to 8 feet, \$2.50.

SPECIAL NOTICE ON GUARANTEE

We spare no effort to supply trees, plants and shrubs of the best quality in first-class living condition. On account of the many causes beyond our control we regret we cannot guarantee this stock to live and establish itself, as that is usually entirely within the power of the buyer or planter. If customers desire us to guarantee plants, trees and shrubs to live we will assume such guarantee at an advance of 25 per cent, over and above our usual prices, but not otherwise, and such guarantee will expire within 90 days from date of shipping.

Mulberry, Tea's Weeping (*Morus alba pendula*). Forms a perfect umbrella-shaped head, with slender, willowy branches, drooping to the ground. 1 year heads, \$3.75; 2 year heads, \$5.00.

Oak, Pin (*Quercus palustris*). Foliage deep green and finely divided; the leaves become a shade of scarlet and yellow in autumn. It thrives in almost any soil. 8 to 10 feet, \$4.50.

Oak, Scarlet (*Quercus coccinea*). A large, well-shaped tree; in the fall the foliage changes to a brilliant scarlet. 6 to 8 feet, \$3.75; 8 to 10 feet, \$5.00.

Plane, Oriental (*Platanus orientalis*) (*Buttonwood*). A favorite tree for avenue and seashore planting; of large spreading habit and rapid growth; not affected by insects. Leaves large, smooth and handsome, affording abundant shade. 8 to 10 feet, \$3.00; 10 to 12 feet, \$5.00; 12 to 14 feet, \$6.00.

Poplar, Carolina (*Populus Caroliniana*). Good in almost any location. 8 to 10 feet, \$2.50.

Poplar, Lombardy (*Populus nigra italica*). Its tall form, sometimes reaching 120 feet, makes it indispensable in landscape effects for breaking monotony of outline. 6 to 8 feet, \$2.00; 8 to 10 feet, \$2.50; 10 to 12 feet, \$3.50.

Salisbury, Adiantifolia (*Maiden Hair Tree*). One of the oddest and most peculiar of all hardy exotic trees. Its leaves are deciduous, fan-shaped, broad and notched, resembling those of the Maiden Hair Fern. 6 to 8 feet, \$2.50; 8 to 10 feet, \$3.00.

Tulip Tree (*Liriodendron tulipifera*). A popular native deciduous tree, sometimes attaining a height of 75 to 100 feet. 6 to 8 feet, \$3.00; 8 to 10 feet, \$5.00.

Umbrella Tree (*Catalpa bungei*). For the lawn the *Catalpa bungei* is very effective. Has a dense, perfect, half-globular or umbrella-shaped head, high on a straight upright stem. On terraces when used in connection with the California Privet hedge the effect is most pleasing. Price, 5 to 6 feet stems, 1-year heads, \$3.75 each; 5 to 6 feet stems, 2-year heads, \$6.25 each; 6 to 7 feet stems, 4-year heads, \$9.50 each.

Weeping Willow, Common (*Salix babylonica*). This is the well-known Weeping Willow, whose long pendulous branches droop so gracefully, and sway to the slightest breeze. Grows well in wet or dry places. 6 to 8 feet, \$2.00; 8 to 10 feet, \$3.00.

Weeping Willow, Thurlow's (*Salix Elegantissima*). Similar to *Babylonica*, but more upright. 8 to 10 feet, \$2.00; 10 to 12 feet \$3.00.

MICHELL'S SELECT FRUITS

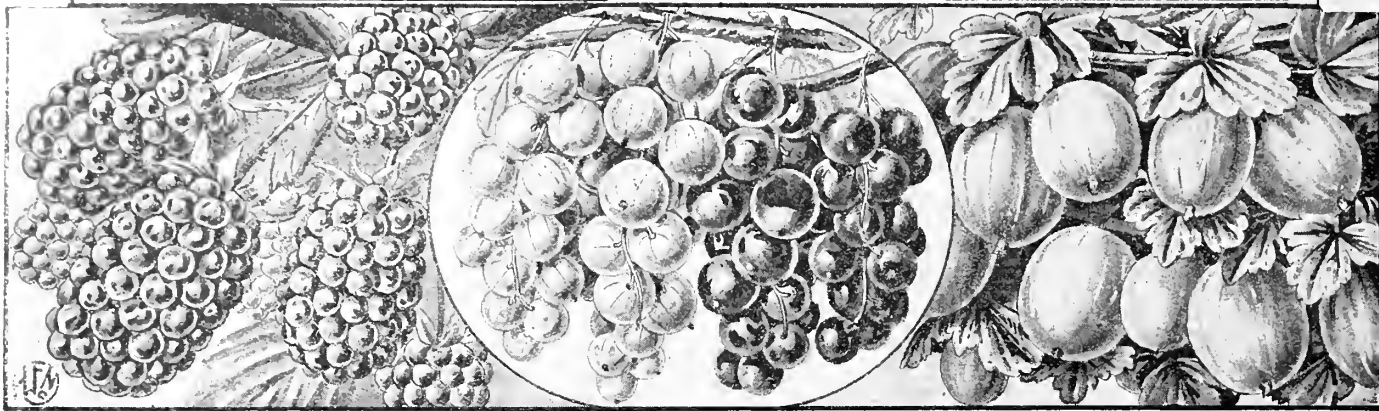

Blackberry, "Eldorado"

Currants

Gooseberries

HAVE YOUR OWN FRESH PICKED FRUIT

Unquestionably one of the joys of living in the country or suburbs is the fact that one can plant a plot of fruit; the space at command will of course govern what you may have, but in the wide variety there is at least one or more for which space should be made. None bought in the market can compare with those picked fresh by yourself when you want them. Any surplus that cannot be consumed may be put up for winter use.

NOTE.—Owing to the peculiar laws of Florida and Mississippi concerning the shipping of nursery stock into those States, we regret **WE ARE UNABLE TO ACCEPT ORDERS FOR NURSERY STOCK or SMALL FRUITS FOR SHIPMENT WITHIN THOSE STATES.**

SPECIAL NOTICE ON GUARANTEE

We spare no effort to supply "small fruit" bushes of the best quality in first-class living condition. On account of the many causes beyond our control we regret we cannot guarantee this stock to live and establish itself, as that is usually entirely within the power of the buyer or grower. If customers desire us to guarantee these and trees and shrubs to live we will assume such guarantee at an advance of 25 per cent. over and above our usual prices, but not otherwise, and such guarantee will expire within 90 days from date of shipping.

BLACKBERRIES (Extra Strong Plants)

Blackberries thrive most anywhere. The plants are subject at times to attacks of rust, particularly during prolonged wet spells in summer. A spraying, especially underneath the foliage, with copper solution, usually arrests this. However, if the disease spreads too much, it is best to dig up the bushes, burn them and plant new ones in another part of the garden. If they are sprayed before being affected it is the best plan.

Bushel Blackberry. Perfectly hardy. A delicious, large berry of finest flavor, and a very heavy cropper. In growth it is like the Black Diamond. Must be trained on poles or trellis.

Eldorado. A very vigorous grower, free from mildew or rust; very productive; fruit large, excellent quality and without core.

Iceberg. Each home garden should boast some white blackberries, and this is unquestionably the best yet produced. Clusters of white berries are produced very profusely in midseason and are both sweet and tender. It is not as hardy as some of the black varieties. As the blossoms are lacking in pollen, it should be planted near some black fruited variety in order to yield freely.

Mersereau. Remarkably strong grower. An enormous producer of extra size berries, which are brilliant black, and retain their color under all conditions; very sweet and without core. Unsurpassed as a shipper and keeper.

Ward. An extra strong grower; produces an enormous crop of extra large, glossy black berries, which are rich, sweet, and tender and with no hard core.

Price of Blackberries, \$1.00 per doz.; per 100, \$7.00.

Note.—If Blackberries are desired by Parcel Post, allow 15c. per dozen for postage, as we send out only extra strong plants which generally bear some the first season.

GOOSEBERRIES (Extra Strong Plants)

Gooseberries should be cultivated during the growing season and fertilized with manure in the early spring or late fall. Poultry or Pigeon manure is splendid fertilizer for the plants, and where it cannot be readily obtained we recommend a liberal application of Sheep manure. They will repay you for this trouble with an extra big crop.

Downing. Medium to large; whitish green; flesh soft and juicy.

Red Jacket. Berries medium; color, pale red; tender and good.

A wonderful cropper, with clean, healthy foliage.

Price. 30c. each; doz., \$3.00; \$20.00 per 100.

Note.—If Gooseberries are wanted by Parcel Post, please add 25c. per doz. for mailing charges.

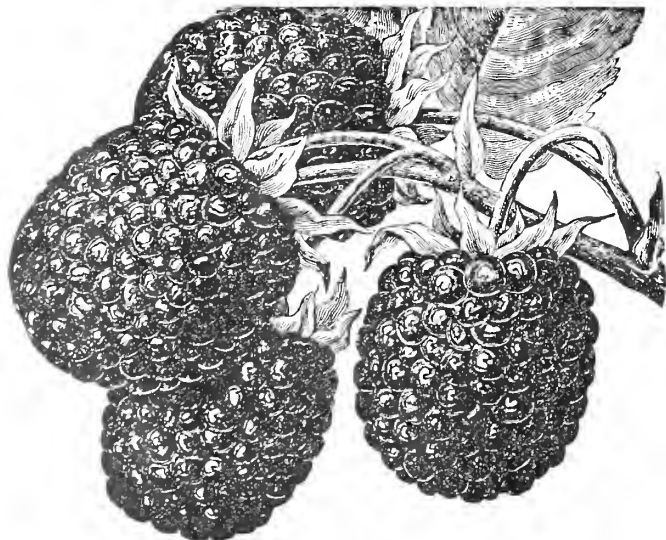

Blackberry, Mersereau

CURRANTS (Extra Strong Plants)

Currants like good, rich soil. They are particularly susceptible to scale, and steps should be taken to keep them free from this by liberal spraying, when the bushes are dormant.

Red Dutch. An old and well-known standard variety; clusters average about three inches long; berries medium in size; dark red.

Price. Strong 2-year old, 35c. each; per doz., \$3.50; \$20.00 per 100.

Note.—If Currants are desired by Parcel Post, add 20c. per doz. for postage, as we send out extra strong bushes.

PLEASE NOTE.—Some States forbid the shipment of Gooseberries into their boundary. Before ordering it might be well to ascertain if there is such a law in your State.

Shipping Seasons for small fruits are usually from March 25th to May 15th and from November till freezing time.

RASPBERRIES (Extra Strong Plants)

Raspberries should be carefully staked, to get large crops. We also recommend that well-rotted manure or other suitable fertilizer be dug around the bushes, either in the fall or early spring. **Cumberland (Blackcap).** The largest raspberry known.

Selected specimens measure an inch in diameter.

Cuthbert. Berries very large, measuring 3 inches around; conical; rich crimson; an old-time favorite.

King. In this extra early variety are united earliness, bright color, firmness and excellent quality of its berries with vigorous growth, productiveness and hardness of cane. Its crimson berries are exceedingly bright in color, firm to endure long shipment.

Red Ranere or St. Regis See Page 144.

Welch. So sweet and rich in flavor, this was at one time offered as "Honey Raspberry." A mid-season variety with berries of extra large size, good, bright crimson color and honey sweetness, melting and luscious. It is not firm enough to ship well a long distance. The canes are vigorous, hardy and productive. Superb for the home garden.

Price, \$1.00 per doz.; per 100, \$7.00.

If Raspberries are wanted by mail, add 15c. per doz., postage.

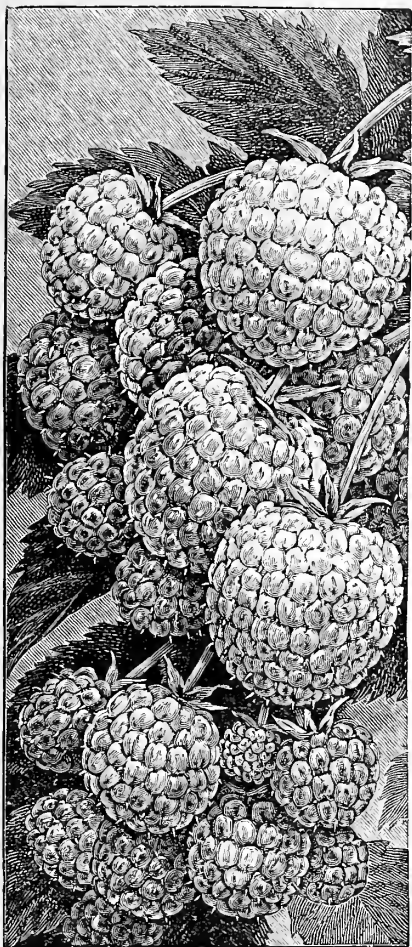

Raspberry, Cuthbert

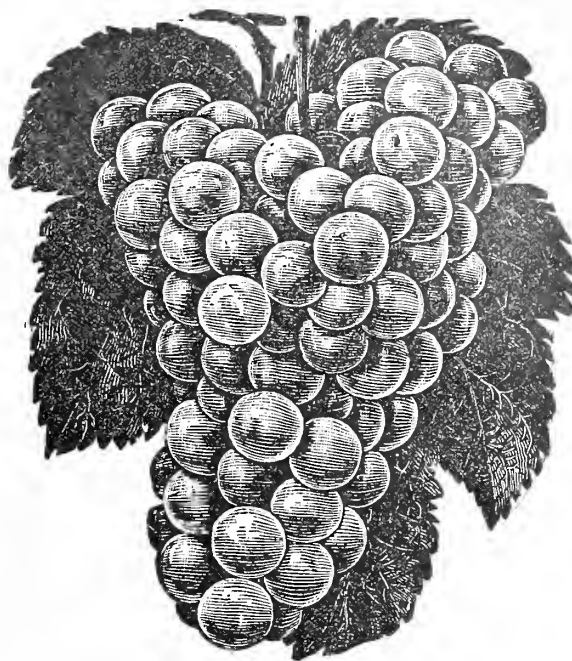

Grape, Caco

GRAPE VINES

A few of these planted in the garden, after several years will yield abundant crops, and they last for years with little attention except pruning and spraying.

Caco. The most delicious of all Grapes—perfectly hardy; has been pronounced by America's most expert grape growers to equal in high quality and melting texture the finest varieties grown under glass. When one considers the price of the greenhouse product and realizes that the wonderful Caco can be grown in the back yard, almost without attention, the force of the above statement is apparent. The large berry is wine-red. Bunch of good size, compact and of good form. Ripens in ten days to two weeks in advance of Concord; rich in sugar, excellent in flavor. Vine very strong, vigorous grower, healthy and prolific. This is a very fine variety and is easily worth the slight advance in price over the older varieties, \$1.00 each; doz., \$10.00.

Campbell's Early. A valuable and delicious grape; vine very strong, hardy and vigorous, with thick, healthy foliage; berries large, black, with light purplish bloom; skin thin; few and small seeds; flavor rich and delicious.

Catawba. Delicious flavor; medium size, red berry.

Champagne. A sterling variety of greatest merit. Color a coppery red. Berries very large. Immense producer. Seasons in which other varieties did not fruit, this variety stood out bearing an immense crop. Very strong grower, fifteen to twenty feet or more a season being common. Has never been known to winter kill. \$1.00 each; doz., \$10.00.

Concord. The well-known standard purple variety; succeeds wherever grapes will grow.

Ives. One of the most prolific bearers; medium size; color, purplish black.

Moore's Diamond. A strong healthy grower, hardy and productive; color, white; berries large, flesh tender, juicy, but with little pulp; ripens before Concord.

Niagara. An unusually strong grower; bunches very large and compact; berries large, light greenish-white, semi-transparent; has very little pulp and is sweet to the center.

Prices.—Any of the above, excepting Caco and Champagne, 2-year old vines, 50c. each; doz., \$5.00. If Grape Vines are wanted by mail, add 5c. each for postage charges.

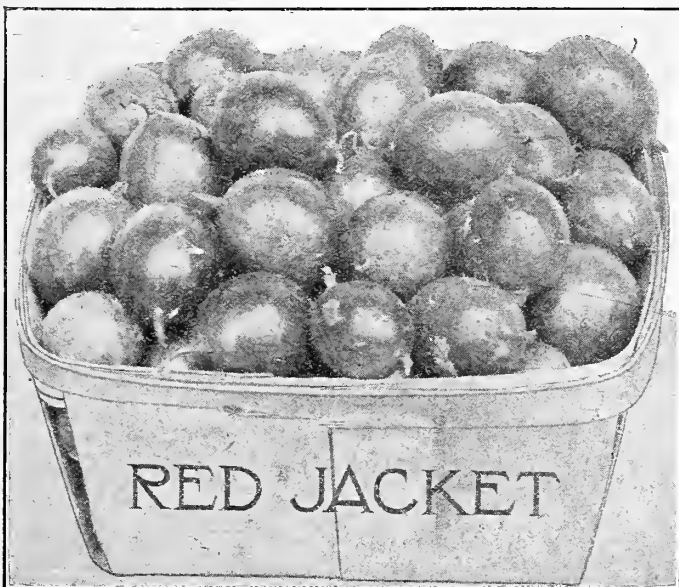

Gooseberry, Red Jacket (See page 142)

Jamison, Pa.

I am sending you a picture of a Bartlett pear tree, two years old, that was bought from you last fall; today, October 2nd, it has two large pears on it. I shall always buy my fruit trees from you.

Mrs. H. S.

MICHELL'S SELECT FRUITS

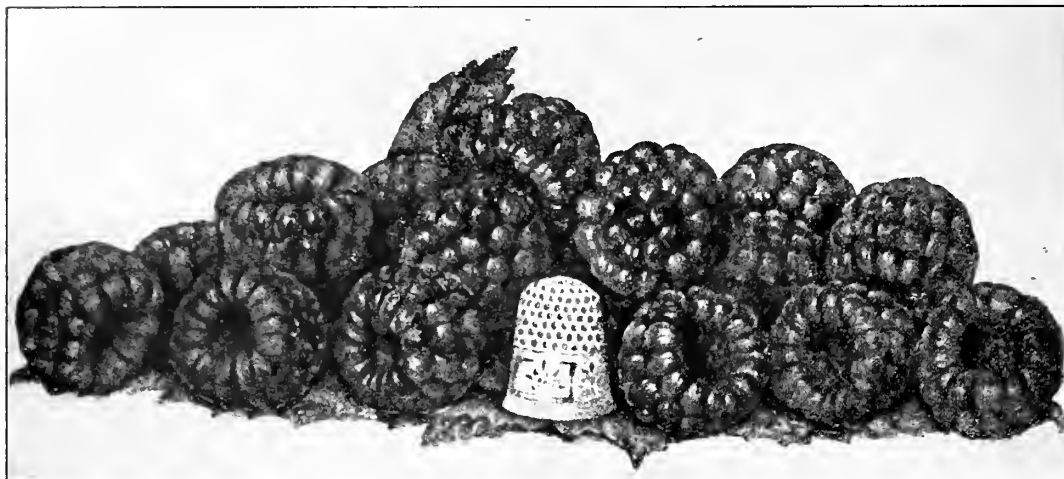

Everbearing Raspberry Ranere

STRAWBERRY PLANTS

There are two types of Strawberry Plants, one known as "Pot Grown," usually ready for shipping in July and August, and the other known as "Layer Plants," usually shipped in the spring months and the latter is what we are offering here. Layer plants set out in the early spring usually bear a few berries the first season, while the main and succeeding crops come the following season and later. The layer plants should be set out in April, when possible, about 1 foot apart, in rows two feet apart.

EARLY VARIETIES

Early Jersey Giant (*Perfect*). Brilliant scarlet-crimson in color, and exceptionally firm. Berries very large, conical with pointed tip. A very heavy yielder.

Premier (*Perfect*). This variety has no weak points, it is a vigorous grower, doing well on all types of soil. The plants are enormously productive, commencing early and bearing through a long season. The berries are beautiful in appearance, having a glossy rich red color extending clear through, and a bright green cap; the flavor is delicious. We consider this one of the very best berries in cultivation.

Senator Dunlap (*Perfect*). One of the first to yield and continues well into the height of the season.

MID-SEASON VARIETIES

Big Joe (*Perfect*). The merits of this splendid variety are great vigor of plant, splendid root system, exceptional productiveness, large size of fruit, excellent flavor, and length of bearing season. The berries are perfect beauties, of very uniform, conical shape, and rich red in color.

William Belt (*Perfect*). Succeeds on all soils, invariably yields heavily, and continues for a long period; the berries are always of large size and highest quality; deep crimson in color and very firm. Continues to bear until almost the close of the season.

LATE VARIETIES

Gandy (*Perfect*). Very large, solid and of a beautiful crimson color; especially good for family garden planting.

Stevens' Late Champion (*Perfect*). "Very large; fine flavored; bright color; good shipper; heavy yielder; good fruit stem." This berry has averaged 7556 quarts per acre.

Price of the above Layer Strawberry Plants. 75c. per doz.; 25 for \$1.00; \$1.50 for 50; 100 for \$2.00; \$17.50 for 1000. We can supply most all other popular varieties though not offered here. If strawberry plants are wanted by mail, add 5c. per doz. or 15c. per 100, for parcel post.

FALL BEARING STRAWBERRIES

Progressive. The berries are medium in size and delicious in quality. The plants continue to bear until freezing weather.

Price of the Fall Fruiting Varieties, 75c. per dozen; 25 for \$1.00; \$1.50 for 50; per 100, \$2.75; \$22.50 per 1000.

If layer Strawberry Plants are wanted by mail, add 5c. per doz. and 15c. per 100 for mailing charges.

EVERBEARING RASPBERRY "RED-RANERE" or "St. REGIS"

The most popular Raspberry in cultivation, bearing continually from July until well into November. Its main crop is produced in the earlier period, but substantial quantities may be harvested almost every day until sharp frosts appear. The fruit is of good size, luscious in taste and excellent flavor, in fact there is no good quality any of the regular varieties of raspberries possess that is lacking in Ranere; a few dozen bushes will supply the average family with sufficient for

table use and a surplus for canning, the color is a brilliant red. Strong plants, \$1.00 per doz.; per 100, \$7.00. If wanted by mail, add 15c. per doz. for postage.



Strawberry Premier

POT GROWN STRAWBERRY PLANTS

Ready usually after July 1st.
Price will be established later.

SPECIAL NOTICE ON GUARANTEE

We spare no effort to supply trees of the best quality in first-class living condition. On account of the many causes beyond our control we regret we cannot guarantee this stock to live and establish itself, as that is usually entirely within the power of the buyer or planter. If customers desire us to guarantee trees to live we will assume such guarantee at an advance of 25 per cent. over and above our usual prices, but not otherwise, and such guarantee will expire within 90 days from date of shipping.

APPLES

- Baldwin.** Large round, deep red, late variety.
Ben Davis. A late keeper; handsome striped fruit.
Fall Pippin. Large, yellow, rich and delicious. A good bearer when it reaches maturity. Likes a moist, well-drained soil; a good Autumn apple.
Grimes' Golden. Deep golden yellow; fine for Christmas.
Hyslop (Crab). Deep crimson with blase bloom.
Red Astrachan. An old popular variety; tart, juicy; flesh tinged with red; very early.
Stayman's Winesap. Fine variety; good keeper; deep red on a yellow ground.
Transcendent (Crab). Yellow, striped red; good yielder.
 Price of Apple Trees: 6 to 8 feet high, \$1.75 each; 6 for \$9.00; \$15.00 per dozen.

APRICOTS

- As fresh fruit few varieties equal in lusciousness the apricot; should be planted more generally where there is room for trees.
Alexander. Orange yellow with faint blush; firm, coarse flesh.
Catherine. Early; oblong shaped; rich orange with red cheek.
J. L. Budd. Early; light orange, similar to Catherine.
 Price of Apricot Trees: \$2.00 each; 6 for \$9.00; \$15.00 doz.

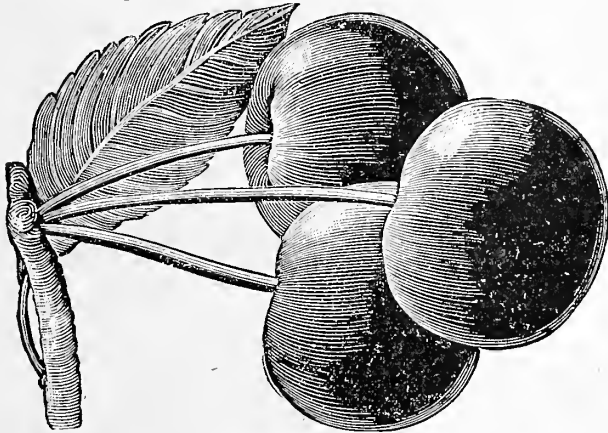

Black Tartarian Cherry

CHERRIES

- In planting cherries care should be taken to set them in ground that is not continuously wet or they will not thrive; in planting see that there is plenty of room for the roots to spread easily, but water them daily for a week after planting to insure quick establishment.
Black Tartarian (Sweet). Large, purplish black; immense bearer.
Early Richmond (Sour). Dark red, medium size; splendid flavor.
Large Montmorency (Sour). Light red; very productive.
Schmidt's Bigarreau (Sweet). A good late variety. Fruit large; flesh dark red, very firm; sweet, rich and of good quality.
Napoleon (Royal Ann). The best and most profitable yellow sweet cherry. Flesh very firm, juicy and delicious.
 Price of Cherry Trees: 5 to 7 feet, \$2.00 each; 6 for \$9.00; \$15.00 per dozen.

PEACHES

- Belle of Georgia.** Free-stone; rich creamy white, red cheek.
Carman. Early; pale yellow, red blush; very fine.
Champion. August. A magnificent white peach; extremely rich and juicy; very popular. Should be included in every home orchard. Free-stone.
Crawford's Late. Greenish yellow with dull red cheek.
Elberta. Medium; very large; yellow with red cheek.
Fox Seedling. Late September. Skin and flesh white. Free-stone. Fruit large and of high quality.
 Price of Peach Trees: 5 to 6 feet, \$1.25 each; 6 for \$6.00; \$10.00 per dozen.

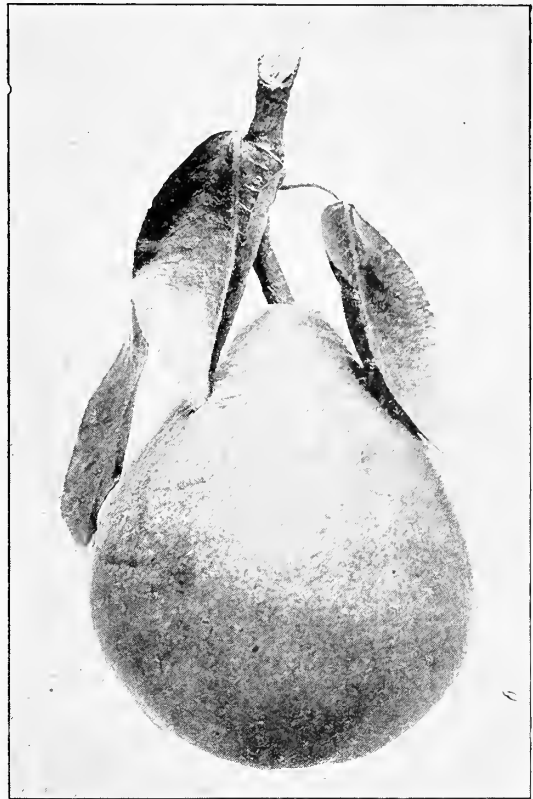

Bartlett Pear

PEARS

- Bartlett.** Yellow, shaded blush; very sweet and juicy; early.
Kieffer. A fine variety for late autumn, and for canning.
Lawrence. Canary yellow; sweet and a splendid keeper.
Sekel. Small; yellowish brown; very sweet and juicy.
 Price of Pear Trees: 5 to 7 feet, \$2.00 each; 6 for \$10.50; \$17.50 per dozen.

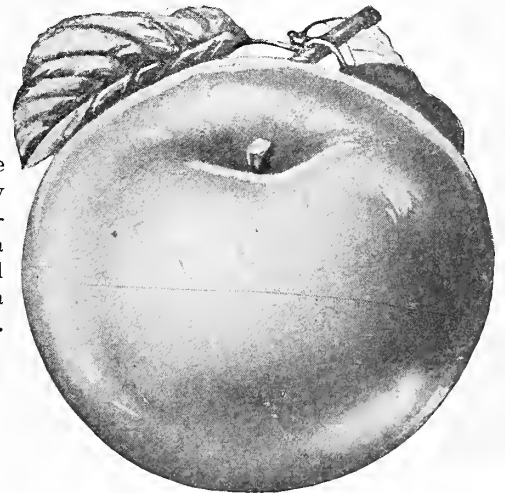

PLUMS

- Abundance.** Amber, turning to a rich, bright cherry color.
Burbank. Orange yellow, overlaid red; rich and sugary.
Imperial Green Gage. Middle of August. A delicious, good-sized free-stone, sweet and juicy. Greenish in color.
 Price of Plum Trees: 5 to 6 feet, \$2.00 each; 6 for \$10.50; \$17.50 per dozen.

QUINCES

- Champion.** Very prolific bearer; large fruit.
Orange. Round; golden yellow; fine for preserving.
 Price of Quince Trees: 4 to 5 feet, \$2.00 each; 6 for \$10.50; \$17.50 per dozen.
NOTE.—We can also supply all other varieties of Fruit Trees.

MICHELL'S FARM AND GARDEN TOOLS

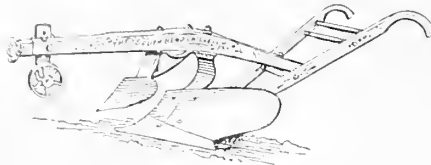

SOUTH BEND PLOWS

For garden, farm or truckers' work it meets every requirement; made of chilled steel in various sizes to meet all conditions.

No. 1B. Wood beam plain, one horse. \$8.75
 No. 2F. Wood beam plain, 1-horse, heavy; or 2-horse, light. 11.50
 No. 3F. Wood beam plain, two-horse. 15.00
 No. 4F. Steel beam, two-horse. 17.00

The prices above are for plain plows with clevis only.

The Nos. 3 and 4 Plows can be equipped with wheel and jointer at the following additional cost: Wheel only, \$2.00; jointer only, \$3.75.

SOUTH BEND PLOW PARTS

	Shares	Mouldboards	Beams
No. 1B	\$0.50	\$2.15	\$1.80
No. 2F	.55	3.15	2.10
No. 3F	.65	4.10	2.30
	Complete Handles	Jointer-points	Land-sides
No. 1B	\$2.00		\$0.75
No. 2F	2.25	\$0.35	1.15
No. 3F	2.25	.35	1.30



SINGLE AND DOUBLE TREES

No.	Description	Price
11	Wood Single Trees, 26 inches, hooks or rings.	\$1.25
11	Wood Single Trees, 28 inches, hooks or rings.	1.35
2	Wood Double Trees, heavy, 36-inch, hooks or rings.	4.25
3	Steel Single Trees, 26-inch, hooks or rings.	2.25
1	Steel Double Trees, 34-inch, hooks or rings.	6.00

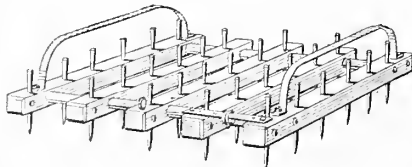

GARDENER'S SPIKE TOOTH HARROW

Though old-fashioned in appearance and construction, this harrow is still preferred by many; fitted with runners, upon which it may be turned to take it from place to place.

24 teeth. \$12.00 | 32 teeth. \$14.00

DISC HARROWS

Discs	Diameter	Cut	Price
8	16 in.	4 ft.	\$55.00
10	16 in.	5 ft.	60.00
12	16 in.	6 ft.	67.50

Prices include pole; if Fore Truck is wanted in place of pole, add \$12.00 to the above prices.

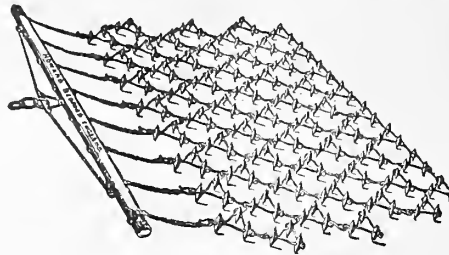

SCOTCH CHAIN HARROW

One of the best implements for pulverizing the surface soil, leveling and smoothing; also splendid for covering grass seed, etc. Used on driveways and race tracks, it smoothes the surface, eliminating ruts and footprints.

No.	Size	Weight	Price
1F.	One-horse size, 5 x 6 ft.	126 lbs.	\$40.00
2F.	Medium two-horse, 6 x 7 3/4 ft.	236 lbs.	55.00
3F.	Full two-horse size, 9 x 11 ft.	357 lbs.	70.00

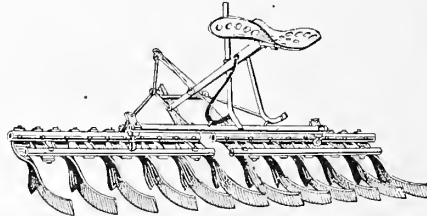

ACME PULVERIZING HARROW

This will be found by those having a large acreage an indispensable implement for pulverizing and crushing the ground.

No.	Description	Price
23.	6 ft. covering area, 2-horse.	\$27.00
G.	3 ft. covering area, 1-horse.	14.00

Extra blades or coulters, \$1.00 each.

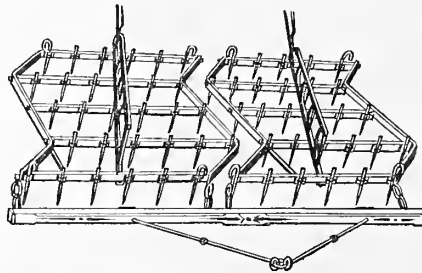

NATIONAL SPIKE TOOTH HARROWS

These are equipped with a lever for lessening or increasing the depth of cultivation and are adjustable instantly. The teeth are equipped so as to readily pass any obstruction in the soil.

Tooth	Sections	Price
25	1	\$14.00
30	1	16.00
50	2	27.50
60	2	30.00

INTERNATIONAL SPRING TOOTH HARROWS

Tooth	Sections	Price
15	2	\$35.00
17	2	37.50
9	1	25.00

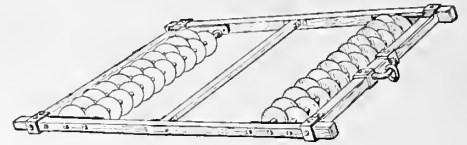

MEEKER DISC HARROW

This harrow leaves the soil a fine seed bed as good as could be prepared with a rake, the ideal tool or implement for dragging over the garden after it has been harrowed; splendid also for dragging over grass field or lawn, prior to sowing grass seed on sod.

No.	Description	Price
1.	4 ft. 6 in. x 4 ft.—46—8 in. discs. . .	\$37.50
2.	6 ft. 8 in. x 6 ft.—58—8 in. discs. . .	42.50
3.	8 ft. x 6 ft.—82—8 in. discs.	50.00
4.	8 ft. x 6 ft.—58—10 in. discs.	52.50

SPECIAL MEEKER HARROW

For use on lawns and golf grounds equipped with 28-8 in. discs, which cut 1 1/2 in. deep under maximum load or weight. 3 ft. x 6 ft. 8 in. for one horse. Equipped with wheels for transporting from place to place readily. Price upon application.

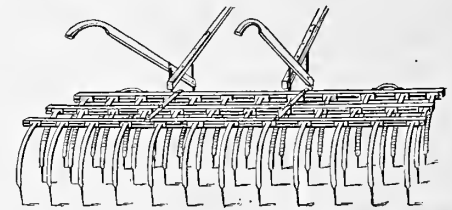

THE KEYSTONE WEEDER

Surface cultivation stirs the soil, keeps down weeds and prevents evaporation of moisture. This weeder can be adjusted to cover a 7 1/2-ft. stretch. Any of the teeth can be easily removed, if it is desired not to cultivate very finely. Excellent for preparing a piece of ground prior to sowing lawn seed, etc. Equipped for one horse. Price, \$15.00. (Extra teeth, 40c. each.)

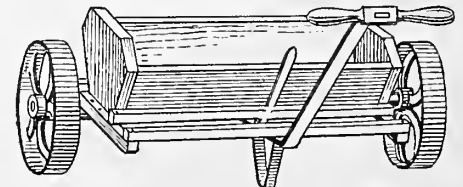

STEVEN'S FERTILIZER DISTRIBUTOR

For distributing bone meal, wood ashes and other commercial fertilizers on fields, lawns, golf courses, etc., also for sanding putting greens. Insures perfect and even distribution, requiring less time than by the broadcast hand process.

Hand Machine. Holds about 1 3/4 bu., covering area 3 feet wide. Nicely finished. Price, \$25.00.

Horse Machine. For use on large lawns, fields and golf grounds. It has a device for either one or two horses, as may be desired. 5-ft. 10-in. spreading area, price, \$70.00; 8-ft. 3-in. spreading area, price, \$75.00, f. o. b. factory.



WHEELBARROW GRASS SEEDER

The distributing box is very near the ground, which is an important feature, preventing the seed from blowing away and thus coming up unevenly. No. 9 (especially for Grass Seed), sows a width 14 ft., \$15.00.



BROADCAST SEED SOWERS

For accurately sowing Timothy, Clovers, Millets and heavy seeds of grass and other farm crops. Can be regulated to sow any required quantity per acre.

	Each
Cahoon.....	\$6.50
Rittenhouse.....	2.75



Prices on Road Scoops

No.	Capacity	Price
1.	Ingham, 7 cu. ft.....	\$14.00
2.	Ingham, 5 cu. ft.....	12.50
3.	Ingham, 3 cu. ft.....	11.50



PEN-VEL FERTILIZER SOWER

A hand power Fertilizer Sower that will sow evenly, accurately and any desired amount all brands of pulverized dry fertilizers. The Fertilizer Box, or Hopper is made of heavy Galvanized Metal and holds fifteen pounds. Any amount of fertilizer up to 2500 pounds can be sown to the acre. The amount sown is under absolute control of the operator, to a fraction of a pound. It is equipped with an Agitator, as well as Force Feeders.

Another feature about the Fertilizer Sower that will find especial favor with the user is that it sows equally well whether being pushed or pulled—that is backward or forward. Attention is called to the cultivator teeth, shown in the engraving; these teeth cultivate the ground as the fertilizer is sown. It is also invaluable for sowing Ground Lime, Ground Sheep Manure, and all Dry Commercial Fertilizers on Lawns and Grass Plots in private and public grounds. Price, \$6.00.

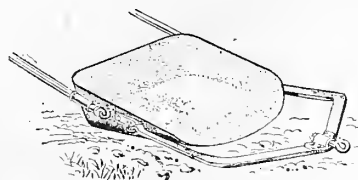

STEEL ROAD SCOOPS

For dragging soil from one place to the other, grading, filling in, etc. See prices opposite.

AMERICAN HAND CORN PLANTER

A great seed economizer and labor saver. Price, \$3.50.

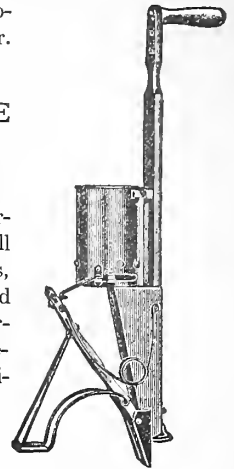

American Hand Corn Planter

J. I. CASE. ONE HORSE DISC CORN DRILL

Equipped with a fertilizer attachment; will also plant peas, beans, etc. Can be furnished however, without a fertilizer attachment if desired. Price upon application.

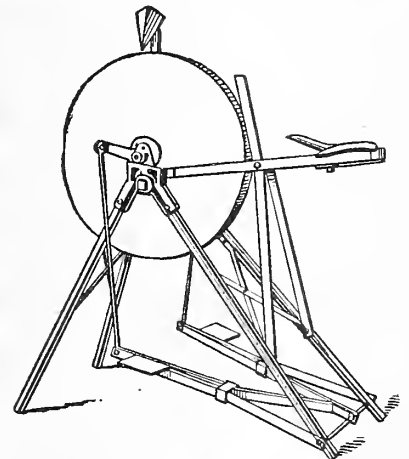

STERLING MOUNTED GRINDSTONE

Substantially made; heavy steel frame, with seat and double treadles; fitted with improved ball bearings, of the very best quality, encased so they will keep clean. Stone, 19 to 22 inches diameter, 1 3/4 to 2 1/4 inches thick. Weight 100 lbs.

Shipped knocked down, crated. Price, \$11.50.

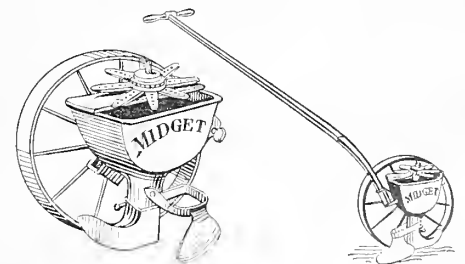

THE MIDGET SEED DRILL

The Midget Seeder will pay for itself in a short time, because it saves seed by sowing accurately. It drills almost any kind of garden seed, including peas and beans. The Midget opens the furrow, sows the seed and covers up, all in one operation. Weight 6 pounds. No. 1. Without handle, \$4.50.

PLANET JR. SEEDERS AND WHEEL HOES

No. 3 PLANET JR. HILL AND DRILL SEEDER
Price, \$16.75

Holds 3 qts. of seed. A favorite among onion growers and market gardeners.

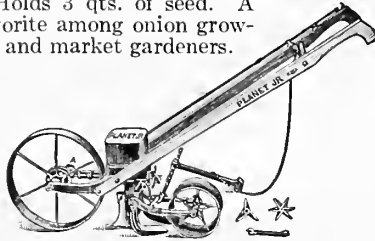

The flow of seed is instantly started or stopped by the cut-off rod. Sows in large or small quantities in drills or in hills.

No. 4 PLANET JR. HILL AND DRILL SEEDER, WHEEL HOE, CULTIVATOR AND PLOW
Price, \$17.25



Sows all garden seeds, plows, opens furrows and covers them, hoes and cultivates.

No. 4D SEEDER. Price, \$13.75.
As above less the cultivating attachments.

No. 25 PLANET JR. COMBINED HILL AND DRILL SEEDER, WHEEL HOE AND CULTIVATOR
Price, \$21.25



A splendid combination for the family garden, onion grower or large gardener.

No. 31 PLANET JR. COMBINED DRILL SEEDER AND SINGLE WHEEL HOE
Price, Complete, \$11.75
No. 31D as a DRILL SEEDER only \$9.25

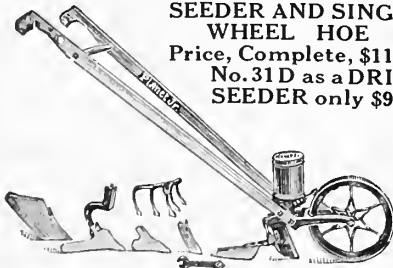

This new tool is of great value to gardeners who have never felt able to own either a seed drill or a wheel hoe. It will sow even a small packet of garden seed with great precision.

No. 11 PLANET JR. DOUBLE AND SINGLE WHEEL HOE, CULTIVATOR, PLOW AND RAKE
Price, Complete, \$14.00



Straddles crops till 20 inches high, then works between.

No. 12 PLANET JR. DOUBLE WHEEL HOE. Price, \$10.75

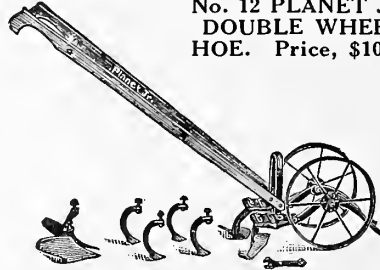

No. 16 PLANET JR. SINGLE WHEEL HOE, CULTIVATOR, RAKE AND PLOW. Price, \$8.75



No. 17 PLANET JR. SINGLE WHEEL HOE. Price, \$7.25
This is the same as No. 16, but without the rakes and leaf lifter.

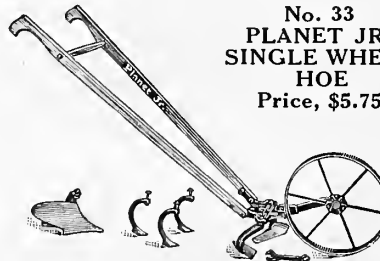

No. 33 PLANET JR. SINGLE WHEEL HOE
Price, \$5.75



No. 35 PLANET JR. SEEDER ATTACHMENT

Ever since the wheel hoe has replaced the hand hoe there has been a demand for a small seeder that could be attached to the wheel hoe. Particularly suited for planting short rows and in small quantities. With one bolt it fastens to any Planet Jr. Wheel Hoe or Garden Plow, or you can bolt a home-made handle to the bracket on the rear of the hopper and go ahead. Price, \$5.50; with handle, \$6.00.

No. 13 DOUBLE WHEEL HOE
This is like No. 12, except that it is equipped with 1 pair side hoes only. \$7.75.
No. 17 1/2 SINGLE WHEEL HOE
Price, \$6.50.
No. 18 SINGLE WHEEL HOE
This is like No. 17, except that it is equipped with 1 pair side hoes only. \$5.50.

No. 14 PLANET JR. DOUBLE WHEEL HOE
Price, \$12.75



The disc leaves the ground fine and level. The prong teeth do fine, deep work. The plows open furrows and cover them.

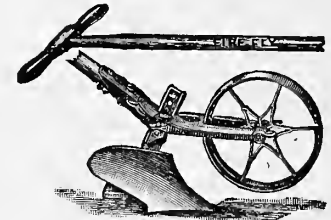

FIRE-FLY GARDEN PLOW

Useful to owners of small gardens, and to chicken raisers for plowing up scratching yards. Price, \$3.75.

PLANET JR. STAR PULVERIZER
Price, \$6.00

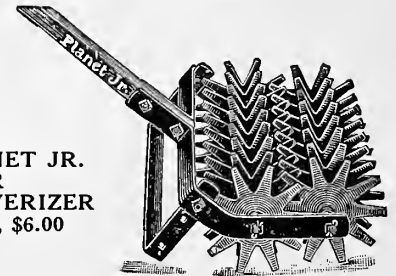

No. 119 PLANET JR. GARDEN PLOW AND CULTIVATOR
Equipped with a 24-in. diameter wire wheel, 1 cultivator tooth, 1 scuffle, 1 2-tooth rake, 1 hilling plow, 1 opening plow. \$4.75.

PARTS OF PLANET JR. WHEEL HOES

Disc Hoes.....	pair	\$3.00
4 1/2-inch Hoes C. & D1.....	"	1.00
6 " Hoes C. & D1.....	"	1.20
7 " Hoes C. & D1.....	"	1.35
8 " Hoes C. & D1.....	"	1.60
Peat Land Hoes.....	"	2.25
3-prong Cultivator Teeth.....	"	2.00
Cultivator Teeth, Regular, No. 1395, all steel, each.....		.35
Narrow Cultivator Teeth, No. 2775, all steel, each.....		.35
Rakes, Three Tooth.....	per pair	1.10
Rakes, Five Tooth.....	per pair	1.50
Plows for Double Wheel Hoes....	pair	1.35
Plows for Single Wheel Hoes....	each	1.35
Double Mouldboard Plows.....		2.00
Handles.....	per pair	1.25

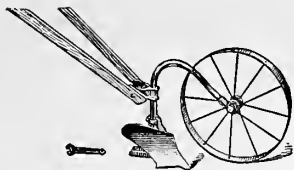

**IRON AGE No. 11
WHEEL PLOW**

The work of hilling up crops in the garden by the hand hoe method is acknowledged difficult by any one who has tried it. Not only will the Wheel Plow do this work with less effort and more rapidity, but does it much better. Price, \$4.50.

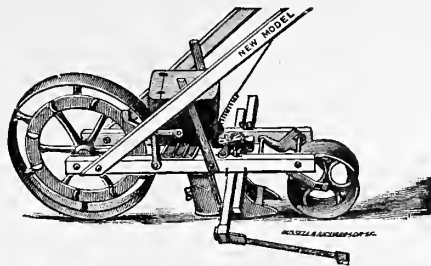

MODEL SEED DRILL

The depth of sowing can be easily regulated. A typical market gardener's drill, having a large capacity for seeds. Price, \$15.00.

**No. 104 PLANET JR.
HORSE HOE**

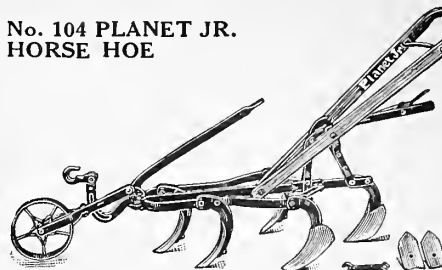

A strong, combined Horse Hoe and Cultivator, with lever wheel and lever expander; light and well adapted to many kinds of work where a heavy tool is not necessary. Price, complete, \$12.75.

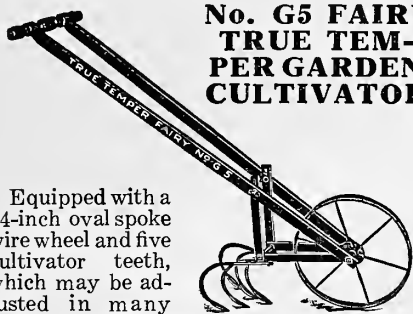

**No. G5 FAIRY
TRUE TEM-
PER GARDEN
CULTIVATOR**

Equipped with a 14-inch oval spoke wire wheel and five cultivator teeth, which may be adjusted in many ways, for cultivating rows from 8 to 10 inches apart. Price, \$4.00.

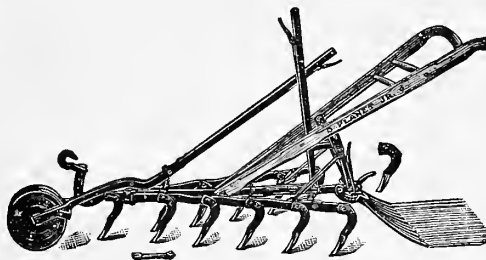

**PLANET JR.
12-TOOTH HARROW CULTIVATOR
AND PULVERIZER**

No. 90. Complete with Steel Wheel, \$16.75.
No. 90B. Without Pulverizer, \$14.00.
No. 90D. Without Pulverizer or Wheel, \$10.75.

With the Twelve-Tooth Harrow, you go as deep or shallow as you like and come up close to row without injuring plants. You widen and narrow as you please, between 12 and 32 inches.

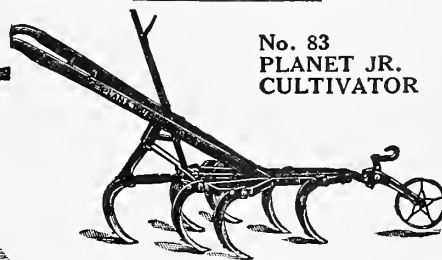

**No. 83
PLANET JR.
CULTIVATOR**

Many gardeners like the 7-tooth cultivator, because it prepares the soil better than does the five-tooth machine. Price, complete with cast wheel, \$14.25. No. 83D, without wheel, \$12.25.

PLANET JR. CULTIVATOR TEETH

Width	Price	Width	Price
1 1/4 inch.....	\$0.16	3 inch.....	\$0.24
1 3/4 inch.....	.18	4 inch.....	.28
2 1/4 inch.....	.21	All 8 inches long.	

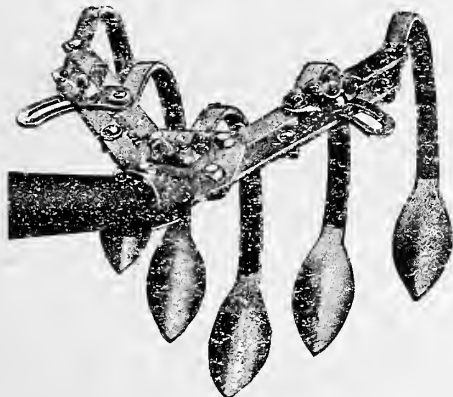

PULL-EASY CULTIVATOR

The teeth are adjustable to various widths; splendid for going between rows of young, growing crops. Can be shipped by express or freight only. No. P. E. 5. Price, \$1.50.

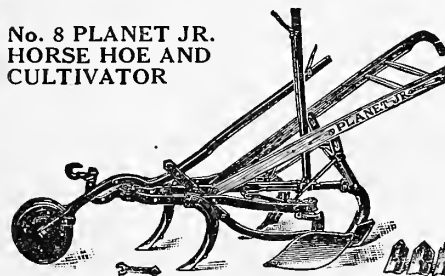

**No. 8 PLANET JR.
HORSE HOE AND
CULTIVATOR**

The lever wheel and depth regulator enable the operator to increase or lessen the depth of tilling by a mere stroke of the arm. A perfect five-toothed cultivator. Price, \$16.75.



**PLANET JR.
CELERY
HILLERS**

Double, for hilling one side of 2 rows. Price, \$27.75.

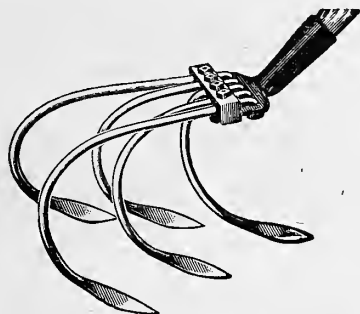

INVINCIBLE CULTIVATOR

This will be found a useful tool for weeding, loosening the soil, preparing seed beds, etc. Price, with long handle, \$1.10.

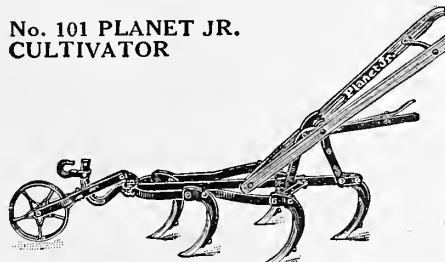

**No. 101 PLANET JR.
CULTIVATOR**

The latest Planet Jr. Plain Cultivator with improved expander. Price, as cut, \$10.50. No. 101D. Price without wheel, \$9.25.

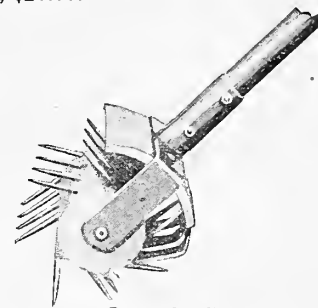

Patent Pending

PORCUPINE CULTIVATOR

A steel covered roller 7 1/2 inches wide, studded with rows of steel spikes, which enter the soil vertically to a depth of about two inches. As the roller revolves these spikes come up horizontally, bringing a section of the earth crust up against the stationary stripper-fingers, which crush and pulverize the soil thoroughly. Fine for loosening up bare spots in the lawn, working in a top dressing of fertilizer and for a dozen other uses which suggest themselves. Price, \$5.00.

MICHELL'S LAWN, GARDEN AND FARM ACCESSORIES

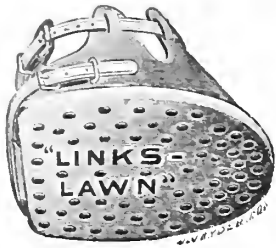

LINKS-LAWN BOOTS (For Horses)

Made of very heavy sole leather, waterproofed and finished black. The sole is reinforced with steel rivets.
 No. 2. 5½ inches inside.
 No. 4. 6½ inches inside.
 No. 6. 7 inches inside.
 Price, per set of four, \$15.00.
 Special Size Horse Boots made to order.

TENNIS COURT MARKER

Junior Line-o-graph. A perfect liquid lime tennis court marker especially designed for private courts; works perfectly on grass or clay. F. O. B., Philadelphia, \$42.50.

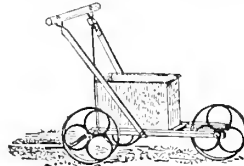

Junior Line-o-graph Tennis Marker

LAWN AND PUTTING GREEN CLEANER

The flexible rake bars are of wood, with steel springs and teeth; they rotate just like a lawn mower cylinder and clean up every particle of leaves, litter or rubbish, throwing it into a receptacle or bag in the rear, which is of large capacity.

24-in. Rake, or Sweeper, \$32.00.

36-in. Rake only, \$45.00.

Please specify when ordering if wanted for lawn or putting greens.



Sweeping Brushes. Can be readily attached to the Rake for sweeping lawns, putting greens, paths, etc. \$3.00 per set of three, when purchased separately. We can also supply the Philadelphia Horse Lawn Sweeper. Price upon application.

SOD PERFORATOR

For use in loosening soil where grass is worn out, for reseeding; makes a perfect seed bed which means quick growth of grass after the seed is sown. It is used like a tamper, its own weight being sufficient to properly perforate the ground; also desirable for use on putting greens, for renovating. Price, \$5.00.



Sod Perforator

SOD TAMPERS

When laying sod it is necessary to properly firm it down, so that it will take new root quickly. It is also convenient for firming the soil or lawn on places where a roller cannot be used; made of iron with wood handle; 12 inches square; weight, 20 lbs. Price, \$3.25 each.

KEYSTONE LEAF RACKS

This device can be used on wheelbarrows with removable sides. Convenient for gathering leaves, cut grass and rubbish. Has a capacity of 10 bushels; made of galvanized wire, bolted to a wooden base. Price, not including wheelbarrow, \$7.50.

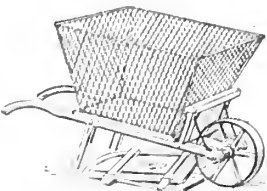

BARREL TRUCKS, ETC.

The price below includes barrel and truck. The latter is constructed so that the barrel may be detached quickly and the leaf rack attached.

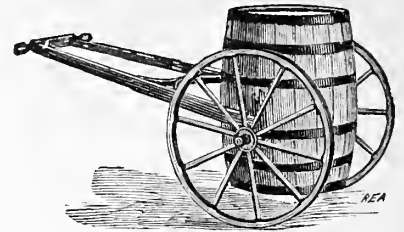

2½-inch tire truck, all iron wheels, with barrel..... \$20.50
 3½-inch tire truck, all iron wheels, with barrel..... 21.50
 Extra Barrels, with trunnions, open head..... 6.50



Wood Leaf Racks

Excellent for gathering leaves, litter, grass, etc. They can be attached to a water barrel truck, as shown above.

Leaf Rack only, no truck \$8.00

Leaf Rack with 2½-inch tire truck..... \$22.00

Leaf Rack with 3½-inch tire truck..... \$23.00

Truck with 3½-inch tire wheels, no rack or barrel..... \$15.00

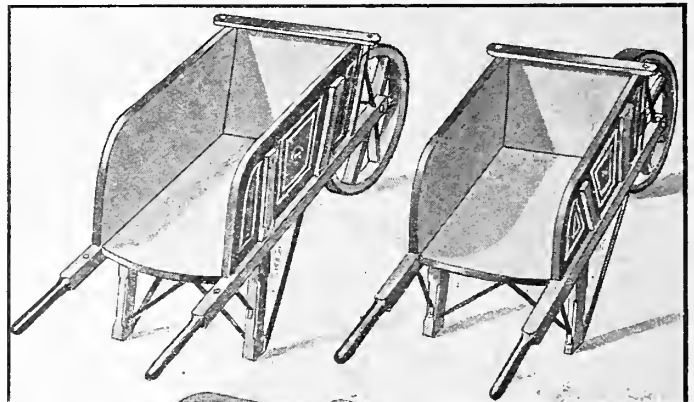

WHEELBARROWS

The measurements of barrows are understood, viz.: Length, meaning inside length of body; depth, inside depth at front; width, outside width at handles.

Ataboy. Steel Tray. Suitable for a lady or a child to use; very substantial; weighs 30 lbs. 48-in. long, 22-in. wide, 20-in. high with a steel wheel tire, 1½-in. Price, \$7.00.

Michell's Special. 26½-in. long, 21-in. wide, 11-in. deep. 1½-in. tire. Price, \$10.00.

Lansing Lawn. 32¼-in. long, 26¼-in. wide, 20½-in. deep. 1¾-in. tire. Price, \$20.00.

Canal. Side dump; bolted. Price, \$6.00.

Eastern. (Boys) No. 2. 21¼-in. long, 20-in. wide; 9¼-in. deep. 2-in. tire. Price, \$7.00.

Eastern. No. 3. 28-in. long; 22-in. wide; 11-in. deep. 1½-in. tire. Price, \$8.00.

Eastern. No. 4. 26¼-in. long; 27-in. wide; 11½-in. deep; 3-in. tire. Price, \$9.00.

Eastern. No. 5. 28¼-in. long; 27-in. wide; 11¾-in. deep; 3-in. tire. Price, \$9.50.

Michell's Greenhouse Style. Narrow body and handle width. Price, \$12.00.

THE MICHELL HIGH WHEEL BALL-BEARING LAWN MOWER

In answer to the call our trade has for years made upon us for a mower of our own name, we have had designed by the best lawn mower makers in the United States the "Michell" High Wheel Ball-Bearing. Of the best material throughout in every detail, there has been the thought to construct not only a mower that would appeal to the intending purchaser from a standpoint of looks, but to give him more for his money than we might be able to do in other makes. The "Michell Ball-Bearing High Wheel Lawn Mower" is made for us by John Braun & Sons, who are the originators and makers of the "Famous Pennsylvania Quality" machines.

It has a 5-blade cylinder of tool steel blades, each hardened and tempered in oil; it is equipped with internal driving gears on both sides, making it easy to push. The cones and cups in which the balls revolve are hardened tool steel, while the balls themselves are extra large, of the best quality. The drive wheels are 10 inches high, which ensures easy running; the bottom knife is self-sharpening with raised edge, of crucible steel, that will ensure long service. It can be regulated to cut the grass at a height of from 1/2 to 1 1/2 inches, by adjustment, while it mows grass with ease that is 6 inches high.

15-inch cut.....	\$19.50	19-inch cut.....	\$25.50
17-inch cut.....	22.50	21-inch cut.....	27.50

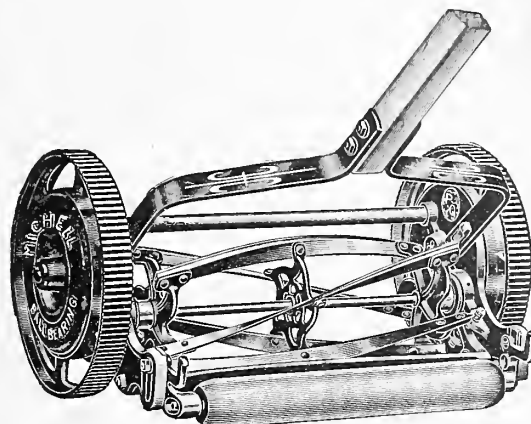

Michell's BB High Wheel Lawn Mower

PENNSYLVANIA LAWN MOWERS

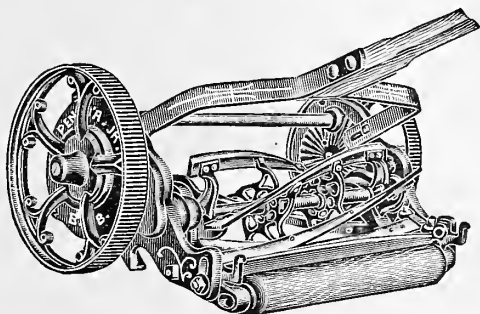

Penna. Jr. BB Lawn Mower

PENNA. JR. BALL-BEARING MOWER

To get the best results from this machine, which does exceptionally fine work, the lawn should be mowed at regular intervals. It cuts the grass shorter than the 4-bladed machine, hence requires mowing at stated periods when the grass is growing rapidly.

8-inch or low wheel, 5-blade cylinder, 5 1/2-inch diameter.			
12-inch.....	\$14.50	16-inch.....	\$20.00
14-inch.....	17.50	18-inch.....	23.00
10-inch or high wheel, 5-blade cylinder, 6-inch diameter.			
15-inch.....	\$25.50	19-inch.....	\$32.50
17-inch.....	28.50	21-inch.....	36.50

THE CONTINENTAL LAWN MOWER

The regulation style for every-day lawns. The Continental is double geared while the Pennsylvania is single geared. High wheel, 10 1/2 inch diameter.

15-inch.....	\$25.50	19-inch.....	\$32.50
17-inch.....	28.50	21-inch.....	36.50

PENNSYLVANIA GOLF LAWN MOWER

For putting greens and close cutting around golf courses, tennis courts, etc.; equipped with an iron roller of small diameter in three sections in place of the usual wooden roller.

17-in. High wheel, Ball bearing, 7 blade cylinder.....	\$34.00
19-in. High wheel, Ball bearing, 7 blade cylinder.....	38.00
21-in. High wheel, Ball bearing, 7 blade cylinder.....	42.00

See illustration opposite column.

Improved Clean Cut Lawn Mower Blade

An attachment which can be fastened to any hand machine that will leave an even, smooth cut turf. Price, for any size machine, \$1.65.

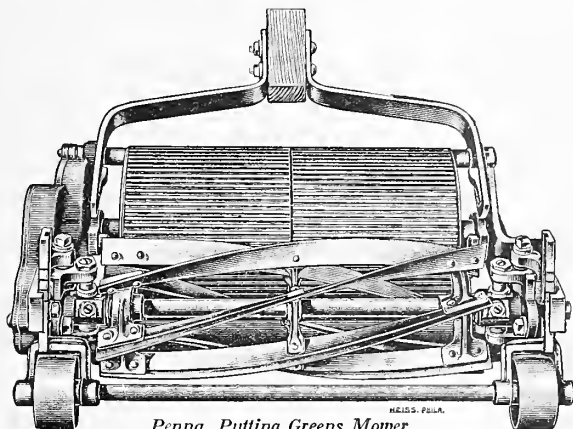

Penna. Putting Greens Mower

PENNA. PUTTING GREENS MOWER

For cutting wavy or undulating greens, which are very popular on some courses. It is gear driven, with 7-inch iron roller in the rear and a wooden roller in the front, to support the machine. The mower can be set to cut as close as 3-16 inch. Equipped with a 6-blade cylinder, 5 1/2 inches in diameter.

16-inch cut.....	\$34.00	18-inch cut.....	\$38.00
------------------	---------	------------------	---------

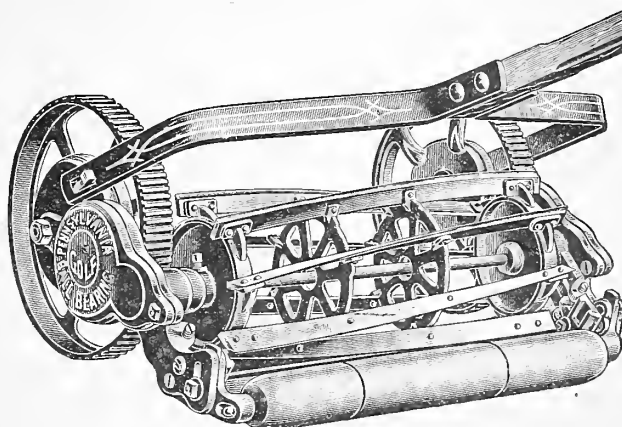

Penna. H. W. Golf Mower

For list of sizes and prices see opposite column.

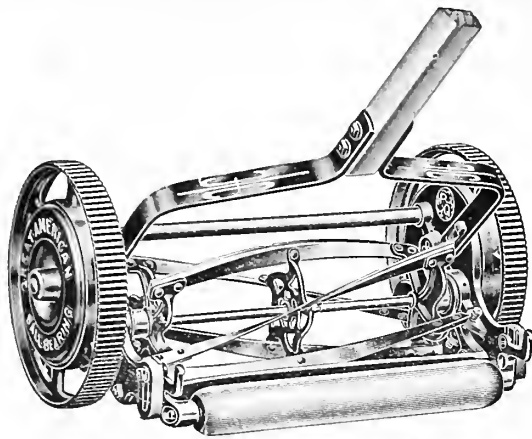

Great American Ball-Bearing Lawn Mower

GREAT AMERICAN BALL-BEARING LAWN MOWER

A high class machine at a medium price; it is regarded as the best all-around mower of its type. The perfectly fitting ball cups and cones insure an easy running machine. 10-inch wheels; 5 blade cylinder, 6 inches in diameter.

15-inch cut.....	\$18.50	19-inch cut.....	\$24.00
17-inch cut.....	21.50	21-inch cut.....	26.50

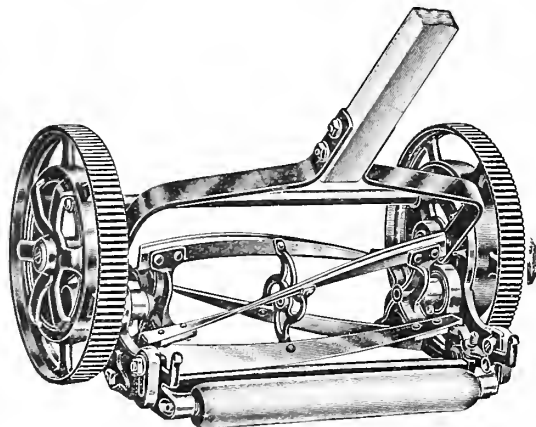

MICHELL'S "ORCHID" BALL-BEARING LAWN MOWER

A splendid moderately priced, high wheel machine; internally driven, making it easy running; four blade cylinder, equipped with the best crucible steel blades.

14 inch....	\$16.00	16 inch....	\$16.50	18 inch....	\$17.00
-------------	---------	-------------	---------	-------------	---------

TOWNSEND GOLF WONDER PUTTING GREENS MOWER

Unusual in appearance and construction, and preferred by many greenskeepers to machines of other makes or types. Can be supplied with or without grass box and deflector.

14-inch.....	\$22.00	18-inch.....	\$27.00
16-inch.....	24.00	20-inch.....	29.00

Grass Boxes and Deflectors for any of the above size Golf Wonders, \$6.50 each.

G. M. LAWN MOWER SHARPENER

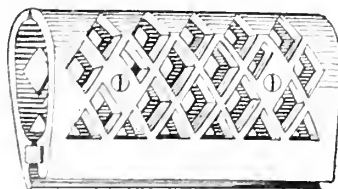

Can be adjusted for any thickness of blade and when properly set will give a uniform bevel, the sharpener following the twist of the knife. It will also sharpen the under blade or dead knife. Price, 75c. each, postpaid. Extra files, 15c. each.

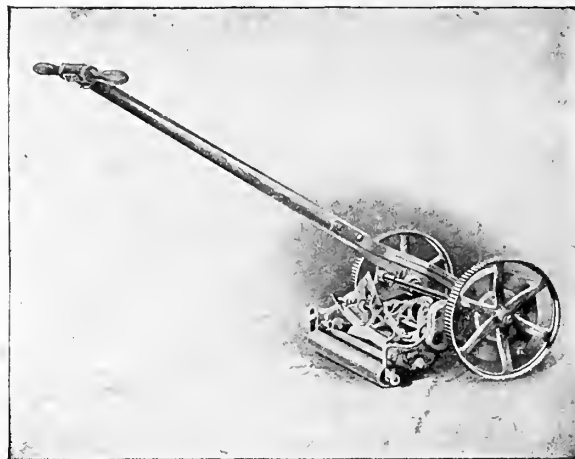

Coldwell Ball-Bearing H. W. Mower

COLDWELL BALL-BEARING HIGH WHEEL LAWN MOWER

The Coldwell line of mowers need no introduction for quality, service and reputation. Easy running, ball-bearing, four-blade cylinder, made to last and do fine work.

14-inch.....	\$17.75	18-inch.....	\$20.25
16-inch.....	19.00	20-inch.....	21.50

JEWEL LAWN MOWER

Made by the Coldwell L. M. Co., to meet the demands for a fairly good, low priced mower, where the size of the lawn does not justify a heavy outlay. High wheel, 4-blade cylinder.

12-inch....	\$7.50	14-inch....	\$8.50	16-inch....	\$9.00
-------------	--------	-------------	--------	-------------	--------

GRASS CATCHERS

Despite what is said to the contrary if you want a good looking lawn you should not allow the cut grass to remain upon it; there are two ways of accomplishing this, one is to rake it off "costly and tedious," the other is with the use of a grass catcher "simple and practical." The weight of the catcher loaded with grass is thrown on the machine proper so that it really adds very little to the labor involved in mowing.

Keen Kutter. Made of galvanized iron bottom and canvas sides.

For mowers 12 to 16 inches cutting width, \$1.65 each; for mowers 17 to 22 inches cutting width, \$2.00.

Braun Make. Galvanized bottom, canvas back and sides. Will fit any of the Pennsylvania line of hand mowers.

12-inch.....	\$3.00
14-inch.....	3.25
15-inch.....	3.50
16-inch.....	3.50
17-inch.....	3.75
18-inch.....	3.75
19-inch.....	4.00
21-inch.....	4.25

Catchers for Penna. Golf and Putting Greens mowers, all sizes, 14 to 21-inch, \$8.00 each.

Catchers for Penna. Horse and Pony mowers. 25-inch for Pony mower, \$5.50; 30-inch, \$30.00; 38-inch, \$38.00.



Showing how the K. C. Grass Catcher looks attached

PENNSYLVANIA LAWN TRIMMER

Made to meet the demand for a serviceable tool to take the place of grass shears and other devices for cutting the grass left at the edge of lawns or borders after mowing. This machine will cut to within $\frac{3}{8}$ of an inch of a wall or tree trunk, and mow any grass border wide enough to run one wheel on. The blades are of best crucible steel; it is ball bearing and self sharpening; built for long years of service, and so light a child can use it successfully; cuts a swath $5\frac{1}{2}$ inches wide; equipped with an 8-inch drive wheel and a four blade cylinder. Price, \$10.50.

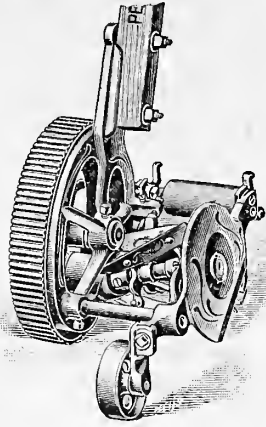

Pennsylvania Regular Lawn Trimmer

PENNSYLVANIA UNDERCUT LAWN TRIMMER

The unique construction of the undercut trimmer permits cutting not only close to a wall, fence, tree, etc., but it will get the grass under a fence or rock cut base of tomb stones, house foundations and other places hitherto out of reach of anything but hand shears. The slanting side plate and conical cylinder make it possible to cut all grass which the regular lawn mower will not reach. Ball bearing, with $9\frac{1}{2}$ in. drive wheel; four blade cylinder. Price, \$12.00.

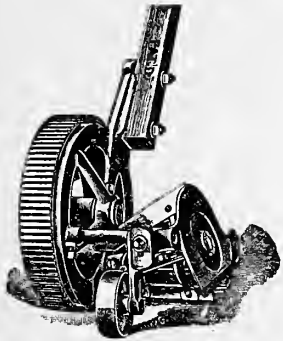

Pennsylvania Undercut Lawn Trimmer

COLDWELL LAWN TRIMMER

A practical machine for trimming along the edges of walks, drives, flower beds and borders; equipped with one large drive wheel and one small guide wheel; 8-in. cut. Price, \$9.50.

BORDER MOWER

A practical machine having a large light cylinder extending the full width of the mower, keeping the machine level with the surface and does perfect work; also a first-class machine for regular lawn work.

10-inch.....	\$18.00
12-inch.....	21.00
14-inch.....	24.00
16-inch.....	27.00
18-inch.....	30.00

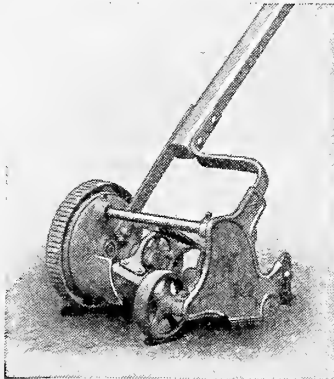

Coldwell Lawn Trimmer

COLDWELL GEM MOWER AND TRIMMER

For terraces and steep embankments, where it is hard to use a regular lawn mower, or for small plots this machine will suit very well; made of first-class material; cuts a swath 8 inches wide; ideal for a small child. Price, \$8.00.

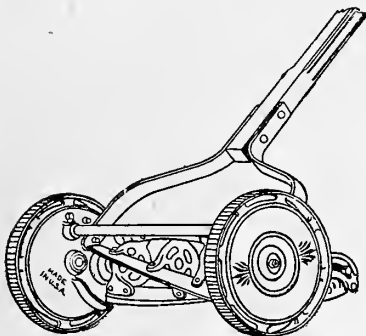

Coldwell Gem Mower and Trimmer

CAPITOL LAWN TRIMMER AND EDGER

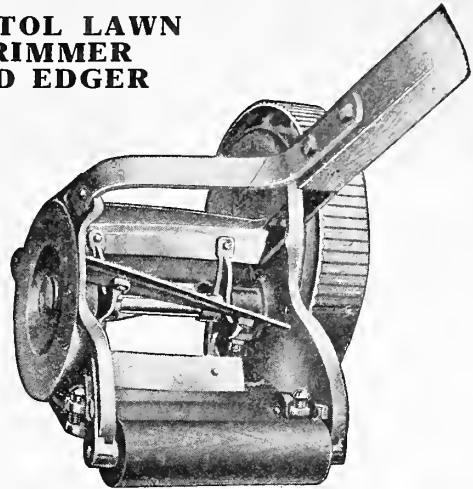

Capitol Lawn Trimmer and Edger

This is the original lawn trimmer and edging device. The steel disc can be adjusted in a few seconds to convert it into a first-class edging device, while for trimming along borders and walks as well as against buildings, fences, etc., it will prove to be an excellent tool; it cuts a swath 6 inches wide, and its purchase will be a lasting satisfaction. The disc is not shown in illustration. Price, \$11.00.



PLANET JR. No. 2, GRASS EDGER

A simple steel disc device, with a flange that runs on the cement path, to cut away the grass which hangs over the edge of the walk; this revolving disc operates very easily and does not cut away any of the soil which some people object to; can be used successfully on straight or curved cement paths. Price, \$1.50.

No. 136, IMPERIAL LAWN EDGE TRIMMER

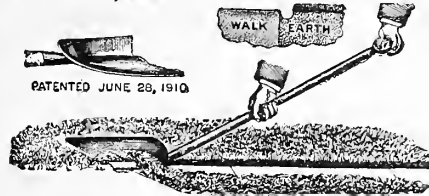

With this tool the rough straggling, overhanging grass along the edges of the walk can be trimmed in a few minutes. It plows a clean U-shaped trench, delivering the cutting on the side-

walk, making it appear as though a barber had performed the work. The edges along the curbing and walk of an eighty foot lot can be trimmed in twenty minutes, leaving the whole surroundings neat and attractive. No other tool will do the work like this. Try one and your neighbors will follow your example. Price, \$1.25.

JAPANESE BROOM RAKE

An ingenious device for cleaning the debris out of a lawn or grass plot, leaving it as free from refuse as though swept with a broom. In fact to get the best results is should

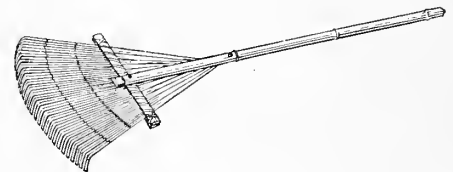

be used with the motion of a broom. No matter how large or how small your lawn is you will want to own one of these Japanese rakes after you have seen or tried them. Made of split bamboo, rigidly secured, with a suitable length handle; the life thereof we do not estimate as being less than five years. Just the thing for cleaning grass clippings from walks and flower beds and borders, and from the lawn too. Positively does this class of work more thoroughly than any other device. We are so enthusiastic as to the ability of this rake to perform better work than any other tool, that we recommend they be purchased with a view of giving them to your gardening acquaintances as gifts.

They cannot be shipped by Parcel Post.

Price each.....	\$ 1.00	} to one address
6 for.....	5.50	
12 ".....	10.00	

IDEAL MOTOR LAWN MOWER

The motor driven lawn mower is rapidly displacing the horse drawn machine on many large estates. Its advantages are readily obvious, chief among which are that when it is not working it costs nothing beyond the interest in the investment. A horse requires care and attention and must be fed every day of the year; a motor mower will cut about four times as much grass with the same size mower as will the horse machine; it leaves no hoof tracks, and keeps the lawn well rolled at the same time as cutting. The Ideal Motor Lawn Mower is equipped with the best and very latest devices, which render it almost fool proof. It comes in three sizes and may be purchased with or without a riding attachment. The company manufacturing these is very strong in every respect and from our own selling experience covering a period of four years, we have not had one dissatisfied customer. We shall be pleased to send complete detailed literature. Prices f. o. b. Philadelphia. 22-in. cut, \$225.00 (without riding attachment); 30-in.-cut, \$340.00 (without riding attachment); 86-in. cut, Triplex style. \$1100.00; Riding attachment for 30-inch machine only, \$25.00 extra.

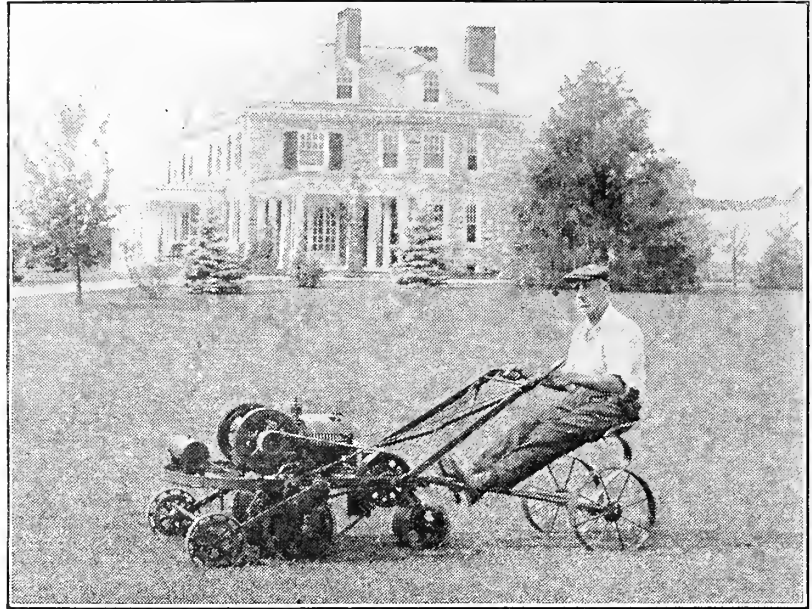

30-inch Ideal Motor Mower with Riding Attachment

4-ACRE POWER LAWN MOWER



It is the smallest, most compact and simple mower on the market today, weighing only 200 pounds, and occupying only a space of 18 x 35 inches when not in use. It cuts a swath of grass 24 inches wide, and travels by its own power at the rate of 3 to 3½ miles per hour, which gives it a cutting capacity of fully four acres per day at a fuel cost of less than 40 cents, and doing the work of 4 to 5 men.

Low first cost, low operating expense and big cutting capacity are the distinguishing features of the 4-Acre Power Lawn Mowers. Performance is the sole standard by which a lawn mower can accurately be judged. This 4-Acre Mower stands

pre-eminent among power mowers and renders exceptional performance under all conditions which a power lawn mower can be expected to work.

To operate the machine, a few turns of the starting crank starts the engine and the upward and downward movement of the clutch handle at steering handle starts or stops the traction of the mower, and by turning the Reel Clutch Handle located on the left side of the machine, the rotation of the reel also starts or stops. A miniature differential enclosed in one wheel makes the steering as easy as that of an automobile. The motor is so well muffled that it can scarcely be heard at a very short distance and with enclosed drive gears running in a constant oil bath the machine is practically noiseless in operation.

Power is transmitted from the engine to the traction wheels and cutting reel through two "cone type" clutches, working independently of each other. Traction can be obtained without revolving cutting reel, thus making it possible to cross graveled drives, sidewalks, etc., without danger of obstruction injuring knives. In case any sticks or stones become caught in the cutter blades while machine is in operation the reel clutch will slip leaving the knives uninjured.

GENERAL SPECIFICATIONS

1 H. P. Motor, 2 cycle, 3 port 2½ inch bore, 2½ inch stroke, 1000 R. P. M. at 3½ m. p. h.; consumes about 1 gal. gasoline per day; cuts 24 in. wide; capacity 4 to 5 acres per day; net weight 200 lbs., crated 250 lbs. Price f. o. b. Racine, Wis., with Grass Guard or \$275.00. Price f. o. b. Phila., freight shipment \$280.00.)

COLDWELL MOTOR MOWERS

Capable of propelling up grades as steep as 25 per cent. Model M. can be equipped with Coldwell's patented demountable cutting units. This device is an extra cutter part, composed of the revolving and stationary knives and the necessary parts to carry them.

Model M. 40 inch cutting area. F.o.b. Newburgh, N. Y. \$1300.00

Model C. 35-inch cutting area. F.o.b. Newburgh, N. Y. 475.00

Model H. 30-inch cutting area. F.o.b. Newburgh, N. Y. 425.00

Model L. 25-inch cutting area. F.o.b. Newburgh, N. Y. 325.00

COLDWELL HORSE MOWERS

30-in., seat and shafts. \$136.00 35-in., seat and shafts. \$157.25

All 4-blade cylinders; 6-blade cylinders, \$15.00 extra.

PENNSYLVANIA TRIO LAWN MOWER

Cuts a swath of 86 inches. So constructed that it does not raise off the ground when the horse starts. The gears are housed in a dust-proof case which is packed with grease, causing them to run noiselessly and free. The cylinder is 7 inches in diameter, equipped with 4 extra wide crucible steel knives hardened and tempered in oil. The wheels are 18 inches in diameter, with a 2½-inch head, giving ample traction surface, and are fitted with annular ball bearings, making it an easy machine on the horses. Weight, 860 lbs. Price, f. o. b. Philadelphia, \$400.00. Extra units, \$100.00 each.

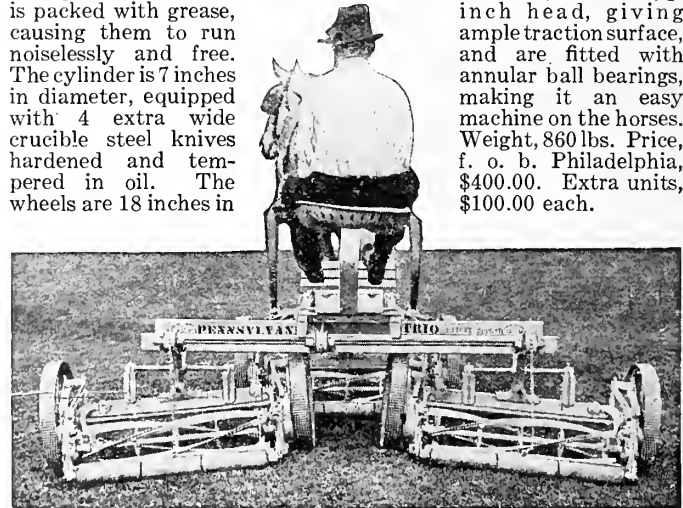

Pennsylvania Trio Mower

TOWNSEND TRIPLEX HORSE LAWN MOWER

This mower can very easily be operated by one horse and a driver; the sections can also be taken apart, so that even a single mow may be used; cuts a swath 86 inches wide; equipped with 5-blade cylinders.

Price, f. o. b. Bloomfield, N. J., \$375.00 complete.

Extra Cutting Units complete, Price, \$100.00.

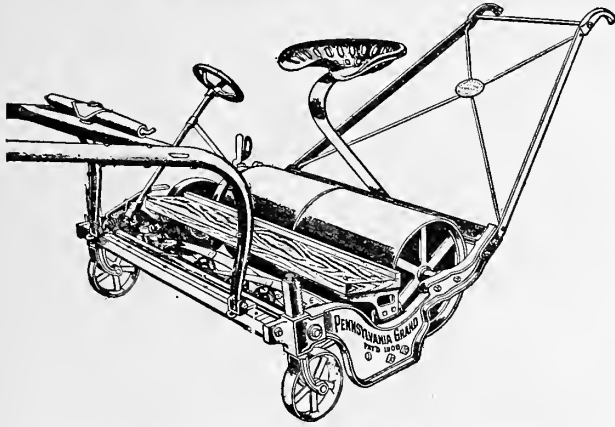

PENNSYLVANIA HORSE LAWN MOWERS

For many years regarded as the best made and they are still without a superior. The bottom and cylinder blades are made of the best crucible steel, tempered in oil. They are of easy draught and will be found more generally used than any other make of horse drawn lawn mowers. The Standard machine is adapted to hilly, rolling lawns, while the Grand style being heavier in construction and weight is the ideal machine for level lawns and grounds; its use serves as a lawn roller as well as a mower. Where there are few trees and little shrubbery a mower equipped with seat and shafts will be found desirable as a man will accomplish more if he can ride rather than walk.

Standard or Regular Style	4-blade cylinder
25-in. Pony, with wooden rear roller (draw bale only).....	\$60.00
30-in., with draw bale only.....	115.00
30-in., with seat and shafts.....	140.00
38-in., with draw bale only.....	150.00
38-in., with seat and shafts.....	175.00

Grand Horse Mower (See cut above)	
30-inch cut, with draw bale.....	\$130.00
38-inch cut, with draw bale.....	165.00
30-inch cut, with seat and shafts.....	165.00
38-inch cut, with seat and shafts.....	190.00

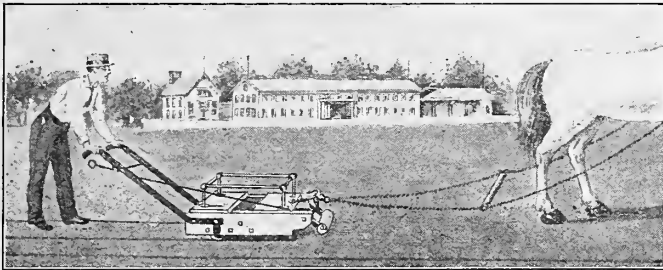

Champion Sod Cutter

CHAMPION SOD CUTTER

One man and a horse with this machine can cut more and better sod in one hour than 10 men can cut in a day with other methods. Has a **Reversible Knife**. The sides and bottom are made of one piece of steel, so that there are no openings that can get choked. A roller just over the knife regulates the thickness of the sod from 1 to 2 inches. The back roller works automatically. By holding up the handles and lever, the roller swings under the machine and takes the weight until you are ready to cut again; in cutting, the two rollers take the weight, thus preventing any friction or injury to the grass; the clearer and guide shoes are reversible and can be changed in a moment; the back is left open so that the knife can be cleaned without turning over the machine. Cut the first strip of sod without guide or clearer; then remove the strip about 1 inch to allow guide to run in. Put guide always in front and clearer behind knife where the loose bolts are. Place the guide and clearer always on opposite sides. See that the knife is kept clean; if the sod is very dry, put extra weights on to 200 lbs. For quick work it is not necessary to use guide and clearer; for good work cut and roll the ground well. This is the only sod cutter that will cut both ways; a whole field may be cut without removing any sod. Price, \$50.00. Extra knives for above \$9.00.

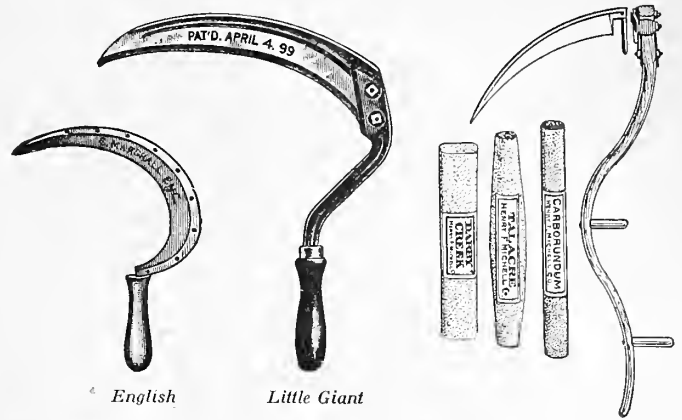

English Little Giant

SICKLES OR GRASS HOOKS

English Rivet Back, No. 2.....	\$1.15
English Rivet Back, No. 3.....	1.25
English Solid Back No. 2.....	1.00
Little Giant.....	.70
P. P. Wt., on Grass Hooks, 3 lbs., each.....	

FLAT FILES

For sharpening lawn mowers.	
P. P. Wt. Each	
8 inch..... 8 ozs.	\$0.35
10 inch..... 12 ozs.	.40
12 inch..... 1 lb.	.50

SCYTHES

Little Giant, 32-inch.....	\$2.25
Little Giant, 34-inch.....	2.25
Little Giant, 36-inch.....	2.25
Little Giant Brush or Briar.....	2.25

The Little Giant is the best American-made scythe for field and heavy grass work.

English, 32-in., rivet back.....	\$3.15
English, 34-in., rivet back.....	3.25
English, 36-in., rivet back.....	3.50

The English Scythes are best for fine grass or lawn work.

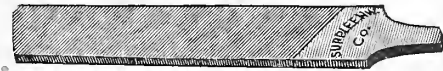

Flat File

SCYTHE STONES

	Each	Doz.
Waterloo (Talacre Style).....	\$0.35	\$3.50
Darby Creek.....	.30	3.25
Carborundum. Very fine.....	.35	4.00

SCYTHE HANDLES, ETC.

No. 50. Made of hard wood, well finished.....	\$1.75
Regular Scythe style.....	.25
Snath Clips.....	

LAWN MOWER OIL



Pure oil that will not gum or get sticky is an essential for the satisfactory operation of every mower. The oil sold by us has been selected with this point in view.

Prices: Per pint, 35c.; 50c. per quart; per 1/2 gal., 75c.; \$1.25 per gal.; 5 gals., \$4.50.

Lawn Mower Oil cannot be mailed

GEM OIL CANS

Finished, Brazed Steel.

	Capacity	Spout	Price
No. 1706.	8-oz.	6-in. (bent).....	\$0.65
No. 1706.	8-oz.	6-in. (straight).....	.65
No. C14AA.	8-oz.	5-in. (straight), Cop- pered.....	.55
No. 1606.	1/3-pt.	6-in. (bent), Steel....	.65
No. 1606B.	1/3-pt.	6-in. (bent), Brass....	1.00

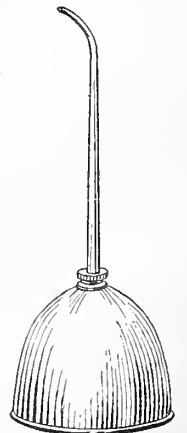

EMERY

For sharpening Lawn Mowers. Price, 15c. per lb.; 10 lbs., \$1.45.

MICHELL'S LAWN ROLLERS, ETC.

It is very essential to roll the lawn when the frost is permanently out of the ground, and again several times during the season. A first class roller will prove a good investment, as it will last almost a lifetime, especially if it is put under cover when not in use.

KEYSTONE HAND LAWN ROLLERS

Drums are equipped with five spokes; the face is ground smooth and carefully finished. The steel roller bearings are mechanically constructed making the roller operate so easily a child can handle it. The handle is made of steel and hard wood; is equipped with a balance weight, so that it is always in an upright position. The drum or roller part has a bevel edge so that it cannot tear up the lawn or ground when being turned.

No.	Diam. In.	Length Width In.	No. of Sects.	Weight Lbs.	Price
501	15	15	2	175	\$16.00
502	15	22	3	250	19.00
504	20	20	2	250	21.00
507	20	24	2	300	25.00
508	20	30	3	350	29.00
509	24	20	2	400	34.00
511	24	24	3	450	37.00
512	24	30	3	500	42.00
514	28	24	3	500	42.00

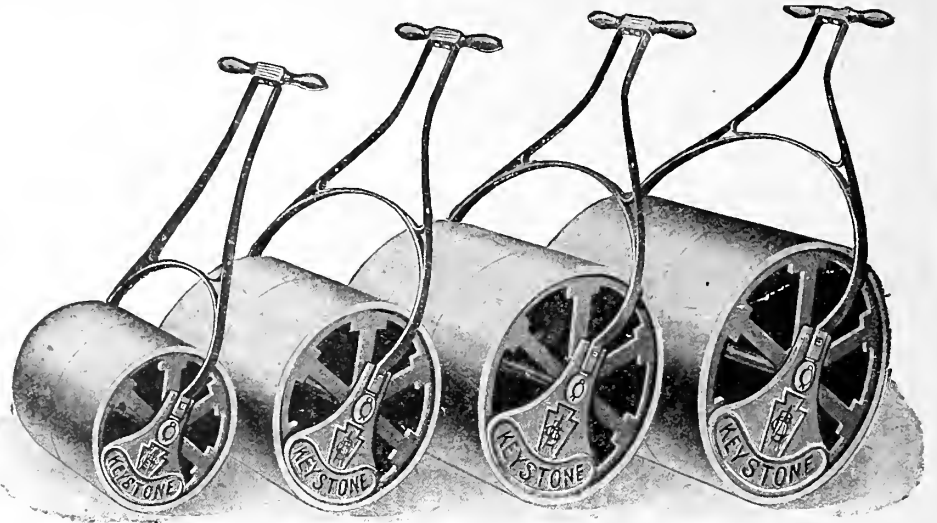

Keystone Hand Lawn Rollers

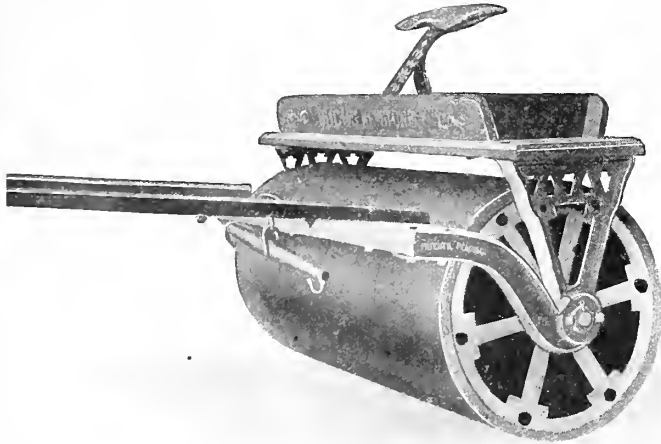

Keystone Horse Roller

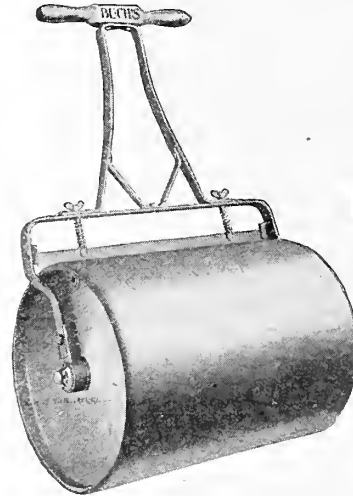

Keystone Water Ballast Roller

AN INVITATION
On the first floor of 516 Market St. (a very spacious show room), we have established what is probably the best arranged display room for Garden and Farm Tools and Implements—Come and see it.

KEYSTONE WATER-BALLAST ROLLERS

Fill it with water, which will weight it up to any number of pounds desired, as shown below. Equipped with feature for balancing handles, which always keeps the handle in position ready for use; ball axle bearings.

KEYSTONE GOLF GROUND AND LAWN HORSE ROLLERS

Made of cast iron carefully finished with beveled edge drums; sizes marked * are equipped with shafts for one horse, the other sizes can be equipped with shafts for one horse or pole for two horses; all sizes are equipped with weight boxes to permit the roller being made to weigh heavier than it is when factory finished.

No.	Diam. Inches	Length Inches	Sections	Weight Lbs.	Price
*341	24	40	4	800	\$61.20
*342	24	50	5	950	70.20
*344	28	40	4	1000	75.60
*345	28	50	5	1200	88.20
370	20	60	5	1150	85.50
371	20	72	6	1300	99.00
372	24	60	5	1450	110.70
373	24	72	6	1700	126.00
374	28	48	4	1350	100.80
375	28	60	5	1650	123.30
376	28	72	6	1950	144.00

No.	Sections	Diam. In.	Width In.	Weight Empty	Weight filled with water	Price
601	1	14	24	60	250	\$18.50
602	1	18	24	75	330	22.25
603	1	24	24	110	440	25.75
604	1	24	32	115	590	28.00

PUTTING GREENS ROLLER

Greens-keepers have found that a roller about 4 feet wide, weighing about 160 pounds, is right; evenly surfaced; will not leave a mark or ridge on the greens. Made of cast steel in 4 sections. \$35.00.

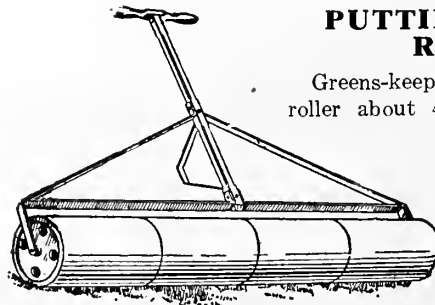

GARDEN AND LAWN TOOLS

Our house makes a specialty of these, and carries probably the largest assortment in practical styles to be found anywhere; the quality is only the very best obtainable and we can readily say our garden and lawn tools give splendid service.

LAWN BORDER SHEARS

Made of finest American steel. They take the place of edging knives and avoid the necessity of doing much stooping. At the same time while making an attractive finish to the grass edge of a walk or driveway, they cut the grass, only leaving the soil intact, in some respects this is desirable. The shear without wheel works equally as well as the one equipped with wheel, this feature is an item of individual preference only. There is one advantage possessed by this type of shear over the edging knife or trimmer, you can use them equally well, whether or not the soil is damp.

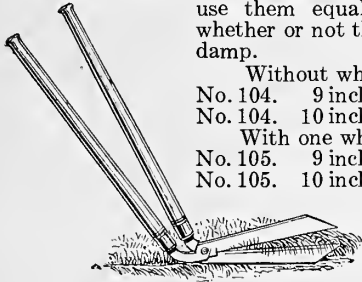

- Without wheel.
 No. 104. 9 inch. \$3.50
 No. 104. 10 inch. 3.75
 With one wheel.
 No. 105. 9 inch. \$4.25
 No. 105. 10 inch. 4.75

LAWN BORDER SHEARS

For trimming under shrubbery, fences and other out-of-the-way places. The two wheels permit the shears to move over the ground freely, backward and forward.



- No. 1062, 9-in. blade, long handle, \$4.25.
 Handles for Border Shears, \$1.00 per pair.



GRASS SHEARS

Do not buy a cheap grass shear, they do not last long, nor do they keep a sharp edge, which is an essential in trimming grass; our list comprises the best makes.

- | No. | P. P. Wt. | Each |
|---|------------------|--------|
| 26. 6 inch, American | 2 lbs. | \$0.50 |
| 114. 7 inch, English, trowel shank handle | 2 lbs. | 2.25 |
| 113. 6 inch, English, straight handle | | 2.25 |
| 113. 7 inch, English, straight shank handle | 2 lbs. | 2.25 |
| 0267. 6 inch, American | 2 lbs. | 1.00 |
| 0267. 7 inch, American | 2 lbs. | 1.25 |
| Goodwin Patent Shears | | 1.75 |

MOLE TRAPS

For catching moles that ruin lawns and damage the contents of hotbeds and cold frames. Moles move usually about 5 A. M. and 5 P. M., so that traps should be set for that period. See illustration opposite column.

- Olmsted \$2.00
 Reddick 1.25
 P. P. Wt. of the above, 3 lbs.



EDGING KNIVES

For trimming edges of paths, etc. No other implement will put a finish to a grass border, a walk or drive, edged with sod like an edging knife; on straight work, it is well to use a garden line so as to make a first-class job, as nothing in the line of gardening looks so badly as edging done in a crooked line.

- *Equipped with handle. Other styles are sold at additional price of 25c. for handles.
 *Mehler Edging Tool \$1.25
 *No. 040. American 1.10
 No. 3863. English, 9 inch 2.25

TURF OR SOD LIFTERS

At times, it is more desirable to sod a bare or worn out spot on the lawn or grass plot than to sow it with grass seed. Our sod lifters are made of the best steel and will never wear out.



American. A convenient device for lifting sod; used extensively by golf course greenskeepers; steel blade, with an 18-inch steel shank and wood D handle. Price, \$1.75 each.



English No. 275. This type is preferred by professional landscape men. Price, \$7.00 each.

Complete Booklet on the Habits of the Mole mailed free, or included with each Mole Trap if asked for at time of ordering.

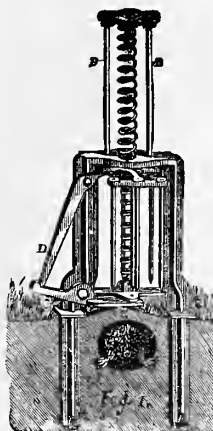

Olmsted

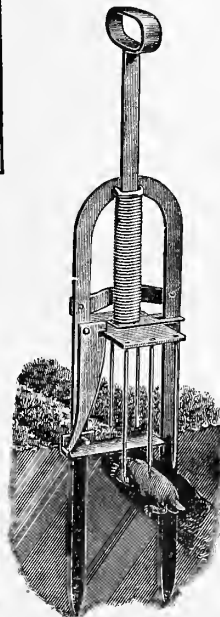

Reddick

See prices opposite column.

RUBBISH BASKETS

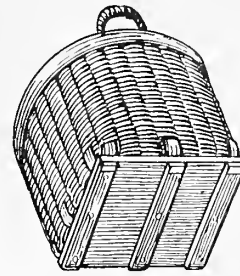

On all large places, on the lawn, in flower and vegetable gardens, a basket for gathering up rubbish and litter will be found a great convenience, especially when it is suited for the purpose. This basket holds 3 bushels and can be carried or wheeled on a barrow. Price, with rope handles, \$4.50 each.

wheeled on a barrow. Price, with rope handles, \$4.50 each.

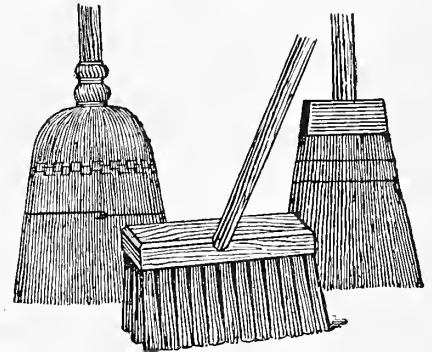

Plain Corn Rattan Push Jap. Fibre

BROOMS AND BRUSHES

For sweeping paths, gutters, roads, etc.; all with handles.

BROOMS

- No. 230. Japanese Fibre \$0.90
 No. 8. Corn and Rattan mixed 1.20
 Golf Greens (Birch)35
 No. 7. Plain Corn, extra quality 1.10

ROAD BRUSHES

(With Handles)

- No. 271. Rattan Push, 14 in. \$1.40
 No. 0286. Brass or Cocoa Push, 14 in. 1.40

THE "OUT-U-KUM"

WEED PULLER

An Entirely New Principle

A slight Push and Pull thoroughly loosens the surrounding soil and removes not only the weed, but the entire root.

When pushed into the ground, the two points guide the BRIDGE down alongside the weed, loosening the soil from that side. It then crosses under the root disengaging the latter. As the tool is withdrawn the BRIDGE slips up the opposite side of the weed, loosening the ground from that side and engages the head of the weed above the ground. The now thoroughly loosened weed is readily withdrawn in its entirety with little or no clinging soil.

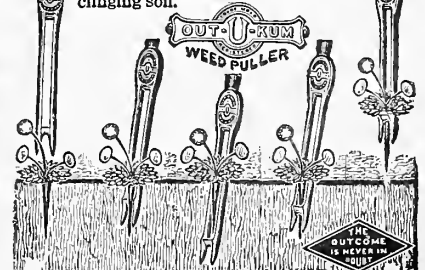

Price of the Out-U-Kum Weed Puller \$1.00 each.

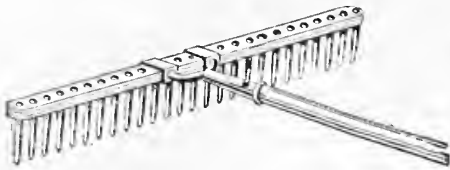

OLE OLSEN LAWN RAKE

Made of best hard wood, well braced; teeth set close together.

26-tooth, hickory wood. Price, \$1.25.

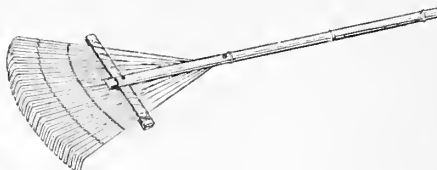

JAPANESE BROOM RAKE

An ingenious device for cleaning the debris out of a lawn or grass plot, leaving it as free from refuse as though swept with a broom. In fact to get the best results it should be used with the motion of a broom. Made of split bamboo, rigidly secured, with a suitable length handle. Just the thing for cleaning grass clippings from walks and flower beds and borders, and from the lawn.

Price, \$1.00 each; 6 for \$5.50; \$10.00 per doz., shipment to one address.

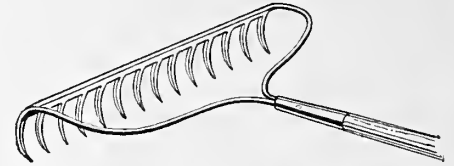

STEEL BOW RAKES

Preferred by many to the regular garden rake, the teeth being slightly bent toward the operator.

No. Tooth		No. Tooth
B12....12....\$1.10		B14....14....\$1.15
B16.....16-tooth.....\$1.20		

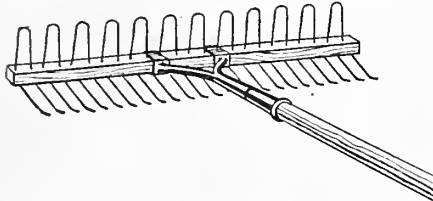

WIRE LAWN OR GRASS RAKE

Made of heavy tinned steel wire. The rake is reversible.

No. Tooth		No. Tooth
124R....24...\$0.85		36LR...36....\$1.25
No. 342...42-tooth.....\$1.40		

No. 342H—42-tooth, very close for cleaning off putting greens, \$1.50.

HOE AND RAKE

(Combined)

An excellent tool for ladies, combining simplicity and utility. Made of the very best steel, which will outlast several cheaper tools of the same class.

No. 4P. 4-prong. \$1.00
No. 6P. 6-prong.. 1.10

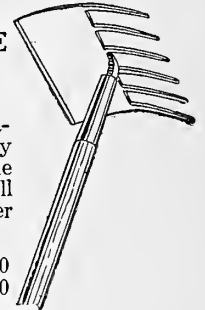

IDEAL DANDELION EXTRACTOR

This simple device is the best thing of its kind ever used for taking weeds out of the lawn. It will be seen that it is not necessary to get down on hands and knees to operate it. The cutting blade is of the best steel, equipped with a convenient handle, so that either man, woman or child can use it. 50c. each.



DOCK LIFTER

For field and farm use; will uproot the deepest seated weed or dock; has tremendous leverage. Made of wrought iron and oak wood; no wear out to it. Price, \$4.00. (Not Mailable.)

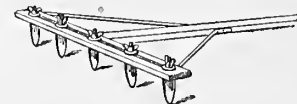

Marking Rake

MARKING RAKE

Has a spread of 4 1/2 ft.; equipped with five adjustable brass teeth; no better method of row marking can be employed; suited for setting plants or sowing seed. The frame and handle are oak; no wear out to it. Price, \$7.00. (Not Mailable.)

Extra Teeth for same. Price, 70c. P. P. Wt., 2 lbs.

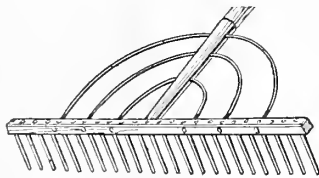

Ames, No. 37X Rake

WOODEN RAKES

Ames, No. 37X. 24-tooth, steel bows.. \$1.40
Ames, No. 30X. 14-tooth, hard wood.. 1.15
Wire Braced. 20-tooth, lawn..... .75



EARLY BIRD RAKE

For breaking, pulverizing and removing worm casts from putting greens, tennis courts and bowling greens. Made of sheet iron; clears an area of 30 inches in width. Price, \$8.00.



STEEL GRAVEL RAKES

No. Tooth		No. Tooth
G12....12....\$1.05		G16....16....\$1.25
G14....14.... 1.15		G18....18.... 1.40
G20.....20-tooth.....\$1.50		

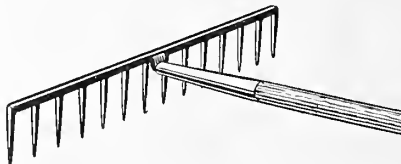

STEEL GARDEN RAKES

Made of best cast steel, with long teeth.

No. Tooth		No. Tooth
6..... 6.....\$0.85		14.....14.....\$1.05
8..... 8..... .90		16.....16..... 1.10
10.....10..... .95		18.....18..... 1.15
12.....12..... 1.00		

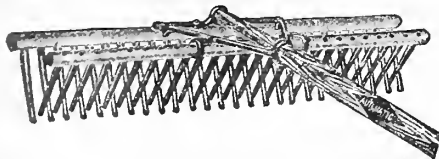

AUTOMATIC LAWN RAKE

A backward motion of the operator clears all the teeth at once.

Wood, 26-tooth \$1.50 | Wood, 38-tooth \$1.75
Galvanized, 24-tooth....\$1.00

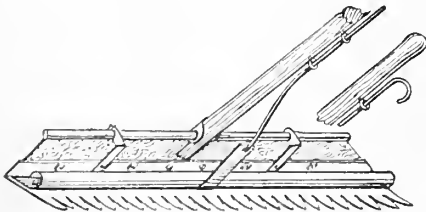

GEM DANDELION RAKE

The rake is so constructed that it cuts off the flower heads and buds, preventing further propagation from seed, when the plants themselves will soon die out. The rake is self-cleaning; can also be used for leaves or grass.

No. 2, 24 inches wide.....\$4.00 each
No. 1, 16 inches wide..... 3.00 each



SQUARE HOES

- No. G06. 6-inch, solid shank.....\$1.00
- No. G07. 7-inch, solid shank..... 1.05
- No. G08. 8-inch, solid shank..... 1.10
- No. 10. 10-inch, for celery..... 1.65



HALF MOON HOES

Best steel, solid sockets, which will not pull out.

- No. HM3. 3-inch.....\$0.95
- No. HM4. 4-inch..... 1.00
- No. HM5. 5-inch..... 1.00
- No. HM6. 6-inch..... 1.05
- No. HM7. 7-inch..... 1.10
- No. HM8. 8-inch..... 1.15

TWO-PRONG ONION HOE

Will be found very valuable in weeding in narrow rows. (See cut below.)

- No. 2P. Price.....\$0.70

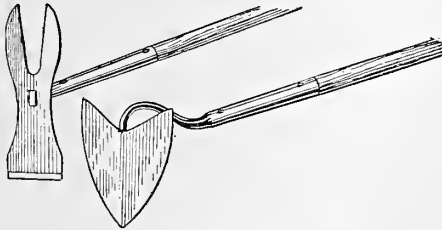

WARREN HOES

Excellent tools for making drills preparatory to sowing of seed. The backs can be used for covering. (See cut above.)

- No. W7.....\$1.15 | No. W7½.....\$1.25

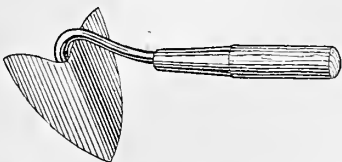

BABY WARREN HOE

- No. BW4½. Short Handle, 60c.



SPECIAL STEEL WEEDING HOE

- No. 3W. Short Handle, 55c.

SCUFFLE HOES

Made of best steel.

- 5-inch.....\$1.10
- 6-inch..... 1.20
- 7-inch..... 1.30
- 8-inch..... 1.40
- 10-inch..... 1.60

Handles for Scuffle Hoes, 25c. each, extra.

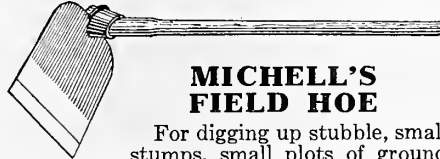

MICHELL'S FIELD HOE

For digging up stubble, small stumps, small plots of ground

- for planting purposes, etc.
- 5½-inch blade, each.....\$1.25

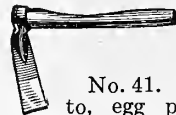

TRANSPLANTING HOE

No. 41. Used for setting out tomato, egg plants and other plants. Avoids kneeling when planting. Made of best steel. Price, \$1.50.



SHOVELS

Long Handle

- Ames, round point.....\$2.25
- Maynard, round point..... 2.75
- Maynard, square point..... 2.75
- Red Edge, round point..... 2.50
- Portage City, round point..... 1.50
- Portage City, square point..... 1.50

Short Handle

- Ames, round point.....\$2.25
- Ames, square point..... 2.25
- Maynard, round point..... 2.75
- Maynard, square point..... 2.75
- Red Edge, round point..... 2.50
- Red Edge, square point..... 2.25
- Portage City, round point..... 1.50
- Portage City, square point..... 1.50



STEEL SCOOP SHOVELS

Strapped shanks, wood D or short handles.

- No. 1. 9 -inch mouth.....\$1.50
- No. 2. 10 -inch mouth..... 1.60
- No. 3. 11 -inch mouth..... 1.75
- No. 4. 11½-inch mouth..... 1.80
- No. 5. 12 -inch mouth..... 1.90
- No. 6. 13 -inch mouth..... 2.00



Michell's Special Spade

STEEL SPADES

- Ames, short handle.....\$2.25
- Maynard, short handle..... 2.75
- Michell's Special, short handle..... 1.50
- Red Edge, short handle..... 2.50
- Nursery (Ames), short handle..... 3.75
- Portage City, short handle..... 1.50
- Boys'..... 1.50



WIRE SCOOP SHOVEL

For handling potatoes, turnips and root crops without bruising or cutting. Made of heavy steel wire.....\$3.00



SNOW SHOVELS

- Adams, wood (see cut), D handles....\$1.10
- Phillips, wood, long handle..... 1.00
- Owosso, galvanized, style like Adams.. 1.75

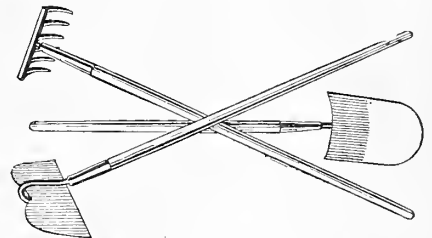

GARDEN TOOL SET

For ladies and children, in fact they are suitable for the country gentleman, consisting of 1 hoe, 1 rake and 1 spade, No. 3PF. Large size, per set, \$1.75.

MANURE DRAGS

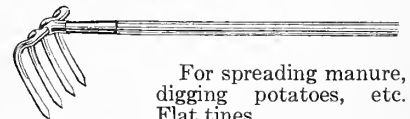

For spreading manure, digging potatoes, etc. Flat tines.

- No. 4BHF, 4 tine.....\$1.50
- No. 6BOH, 6 tine..... 1.85

IMPLEMENT HANDLES

- | | |
|---|--------|
| | Each |
| Axe..... | \$0.45 |
| Spade, plain..... | .75 |
| Fork, Spading, plain..... | .75 |
| Fork, Manure, plain, short..... | .75 |
| Fork, Manure, plain, long..... | .75 |
| Shovel and Spade, short, plain..... | .80 |
| Hoe, plain..... | .25 |
| Rake, plain..... | .25 |
| Pick or Mattock..... | .50 |
| 12-foot Poles..\$2.00 14-foot Poles.. | \$2.25 |

MICHELL'S FARM AND GARDEN TOOLS

MEHLER HANDY HOE

This will do what any half-moon and square hoe will accomplish. It has a wide side and a narrow side, while another part of it will answer as a rake to pulverize the soil. Price, \$1.25.

Please note.—Mehler Garden Tools cannot be sent by Parcel Post.



MEHLER GARDENER

An entirely distinct tool. Avoids bending the back. Works closer to the plant than any other device. No hoe is needed where this is used. Just the thing for working among flowers and vegetable plants. \$1.50 each. Not mailable.



SPADING FORKS

Strapped shanks, short or D-wood handle. Made of best quality steel.
 No. OHW. Men's 4-tine \$2.10
 No. O5HW. Men's 5-tine 2.35
 No. B4D. Boys' or Ladies 4-tine 1.00

ENGLISH DIGGING FORK, No. EB4

Though made in America, it is made exactly after the pattern of garden forks such as are made and used in England. The prongs are solid steel, with square instead of round edges, which adapts it especially for digging in heavy soil, in which it works with ease. Every gardener should add one of these to his collection of tools, as we know it will give him splendid satisfaction. 4-tine, \$2.25 each.

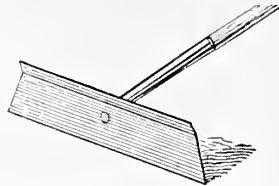

MEHLER HANDY SCRAPER

This was originally designed as a dropping-board scraper in poultry and pigeon houses. It gets in the corners easily and has a sharp crimped edge on the upper side, which is used to loosen up any hard substance. It is also suited for a variety of other work around the farm or garden. Price, \$1.25.



MANURE FORKS

Strapped Shanks.

- 04W—4 tine, light, short handle.... \$1.85
- 163 —4 tine, heavy, short handle... 2.10
- 05W—5 tine, medium, short handle.. 2.10
- 06W—6 tine, medium, short handle.. 2.10
- 044 1/2—4 tine, long handle..... 1.65
- 054 1/2—5 tine, long handle..... 1.85

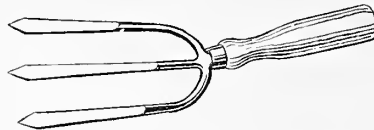

EUREKA WEEDING FORK

No. G. Made of best flexible steel; splendid for loosening soil in the garden, in hotbeds, etc., 50c. Parcel Post Weight, 2 lbs.



EXCELSIOR WEEDING FORK

No. 300. Made of malleable steel, finished in tin, 15c. Parcel Post Weight, 1 lb.

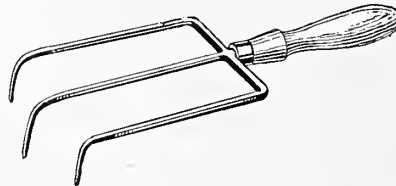

EUREKA WEEDER No. E

Made of flexible steel; very light, an ideal tool for market gardeners, florists and amateurs, 50c. Parcel Post Weight, 2 lbs.



EXCELSIOR WEEDER

Made of malleable iron, finished in tin, 15c. Parcel Post Weight, 1 lb.



HAZELTINE WEEDER

No. Bw1, 50c. Parcel Post Weight, 1 lb.

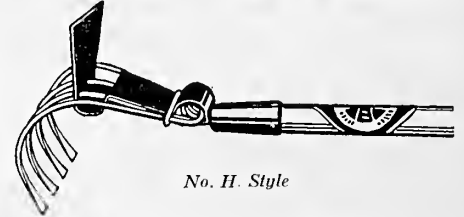

No. H. Style

MAGIC WEEDER

Made of heavy galvanized flexible wire, with flattened prongs or ends.

- No. A. Short Handle, Small \$0.25
- No. B. Short Handle, Medium35
- No. H. Long Handle, Large 1.25



MAKEFIELD WEEDER

A splendid little tool for weeding in the garden seed bed, greenhouse or hotbed; made of fine tool steel, it can be sharpened easily and does not become dull readily; with it you can work closer to seedlings than with any other tool we know of. 50c. each.

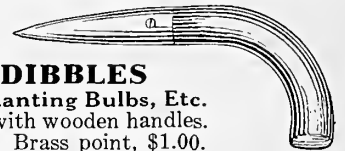

DIBBLES

For Planting Bulbs, Etc. Equipped with wooden handles.
 No. 2180. Brass point, \$1.00.
 No. 218. Iron point, 75c.
 Parcel Post Weight, 1 lb.

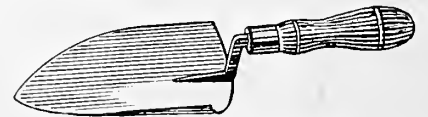

JOHNSON STEEL TROWELS, No. 211

These are made of one piece steel blade and shank, equal to the imported trowels.

- | | | |
|------------------|--------|------------------|
| P.P.Wt. | | P.P.Wt. |
| 5 in. 1 lb. | \$0.80 | 7 in. 1 lb. |
| 6 in. 1 lb. | .85 | |



D. S. T. STEEL SHANK TROWEL

These are somewhat long in blade and handle, making a very practical tool. 6-in. blade, \$1.00 each. Parcel Post Weight, 1 1/2 lbs.



CLEVES' ANGLE TROWEL, No. 217

For getting dandelion, plaitain and other weeds out of the lawn, and transplanting.

	P. P. Wt.	Each
5 inch.....	1 lb.	\$0.30
6 inch.....	1 lb.	.35
7 inch.....	1 lb.	.40

MISCELLANEOUS

TROWELS

	P. P. Wt.	Each
No. 213—5 inch.....	½ lb.	\$0.25
No. 213—6 inch.....	½ lb.	.30
Neverbreak—6 inch, heavy steel, 1 lb..		.25

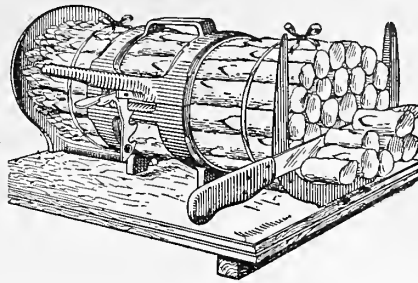

ASPARAGUS BUNCHERS

Even where one has a limited amount of asparagus to market, it pays to use a buncher. It is tied quickly and looks uniform. Price, with knife guard, \$3.75.

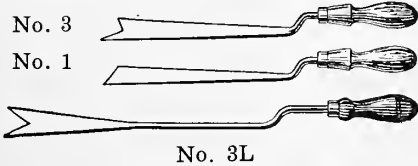

ASPARAGUS KNIVES

Fig. 110, No. 1 American.....	\$0.65
Fig. 110, No. 3 American. V-shaped blade, short handle.....	.65
Fig. 110, No. 3L American. V-shaped blade, long handle.....	.65



AXES

Plumb, medium, man's size. Made of best quality steel.....\$2.50

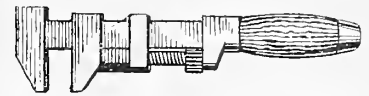

MONKEY WRENCHES

For machinery. Made of first quality hard steel; 8-inch, \$1.00; 10-inch, \$1.25. Parcel Post Weight, 1 lb. each.

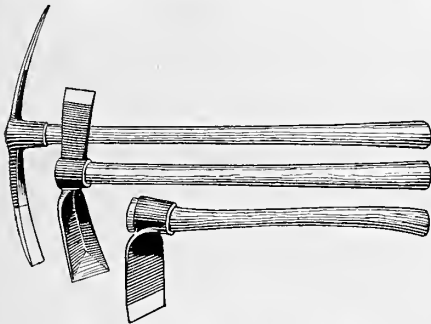

PICKS (Price includes Handle)

All steel. Double point, \$1.50; axe point, \$1.50.

MATTOCKS

(Price includes Handle)

Axe, pointed.....	\$1.50
Pick, pointed.....	1.50
Half Mattocks or Grub Hoes.....	1.50

POSTHOLE DIGGERS



Digger

No. 8. (See Cut.)

This bores a hole 3½ ft. deep and can be adjusted in diameter from 8 to 14 inches, \$5.75.

No. 15. Eureka, \$2.50.

Post Hole Spade

All steel with either point or tamper end, \$2.50.



Spade

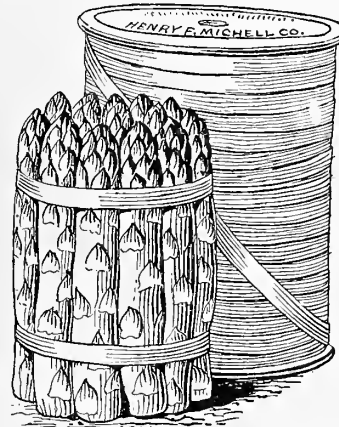

ASPARAGUS TAPE

In fast colors, green and red, glazed finish. 1000-yard spools, per spool, \$4.50.



STEEL HAMMERS

No. 011½ Pexto. Price, \$1.00 each.



HATCHETS

Made of the best quality tool steel, that will keep an edge.

Plumb.....\$1.10



CORN KNIFE

Eureka, bent blade. Weight, 2 lbs... \$1.00

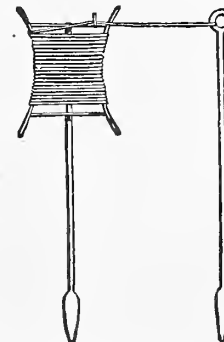

GARDEN REELS

Small, Single...	\$1.35
Medium, Single.	1.85
Large, Double..	3.75
Large, Single...	3.00

GARDEN LINE

Best quality white cotton braid, woven closely.

Single Garden Reel	100 ft. hanks... \$1.50
Plow Line Cotton, 45-ft. hanks.....	.85

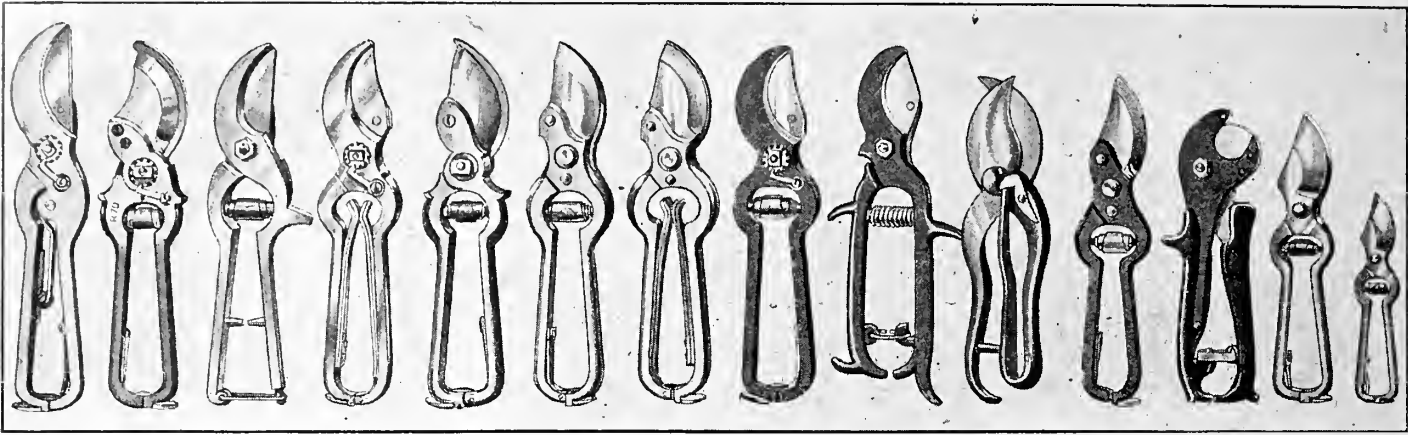

R95 R70 999 R165 Wiss 50 R165 R70 0 110 R50 Levin 14 23

PRUNING SHEARS

Our pruning shears are procured from the most reliable makers and all are fully guaranteed.

No.	P. P.	Wt.	Each
110 Perfection, 8 in.		1½ lbs.	\$3.00
50 Pexto, 8 in.		2 lbs.	1.10
R 50 Pexto, 9 in.		2 lbs.	1.40
55 Pexto, 9 in.		2 lbs.	1.75
R 95 Pexto, 10 inch.		2 lbs.	4.50
110 Pexto, 8 in.		2 lbs.	3.25
109 Wiss, 8 in.		2 lbs.	4.00
65 Pexto American, 9 in.		2 lbs.	1.75
R 165 Pexto American, 9 in.		2 lbs.	2.25
R 70 Pexto American, 9 in.		2 lbs.	2.00
23 Henckel, 4½ in.		1 lb.	1.75
23 Henckel, 6½ in.		1 lb.	2.00
14 Nickeled, 6½ in.		1½ lbs.	1.75
0 Pexto 9 in.		2 lbs.	.65
999 Michell's.		1 lb.	3.00
1586 French, 7½ in.		1½ lbs.	3.25
1586 French, 8½ in.		2 lbs.	3.25

Spiral Springs for any of the above Pruning Shears, 15c. each; per doz., \$1.50. Parcel post weight, per doz., ½ lb.

LEVIN PRUNER No. 23

The handle of these shears affords a great deal of leverage, which makes very easy cutting possible. Price, \$1.00. Weight, 2 lbs.



BRUSH OR BRIAR HOOK

No. 43. Steel cutting blade; long handle. Price, \$1.35



STEEL HEDGE KNIFE

For cutting heavy brush, shrubbery, hedges, etc. Made of the finest steel with a slight hook on blade. Each, \$5.00.

No. 1. Steel Hedge Knife, short handle. \$1.25

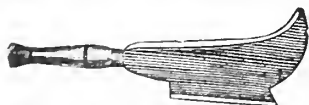

ENGLISH BILL HOOKS

For trimming heavy shrubbery, trees, etc. P. P. Weight, 4 lbs.

Short Handle \$4.00
Long Handle 6.00

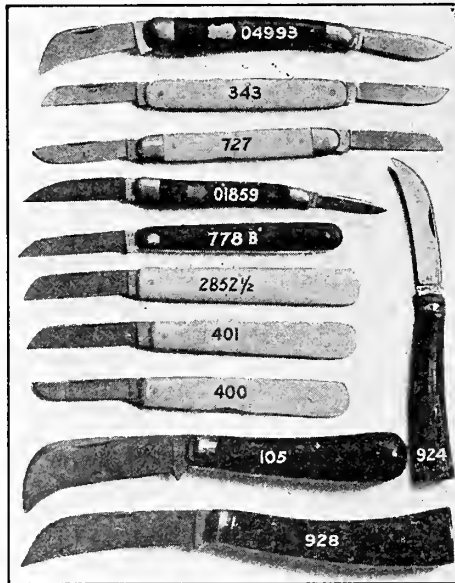

HORTICULTURAL KNIVES

A good knife is an essential to every gardener and florist. Our stock consists of such styles that are practical and in demand. They are all of the best steel. Every one is guaranteed to be perfect.

No.	Blades	Style	Handle	Each
343	2	Saynor,	brass lined, ivory	\$4.00
727W	2	Brass lined,	white	1.75
04993	2	Steel lined,	ebony	1.75
400	1	Saynor,	not lined, ivory	4.00
401	1	Saynor,	not lined, ivory	3.75
2852½	1	Not lined,	bone	1.25
928	1	English,	steel lined, stag	3.00
924	1	English,	steel lined, stag	2.75
778B	1	Brass lined,	ebony	.85
105	1	Heavy,	steel lined, cocco	1.25
303	2	Saynor,	Pruning, stag	2.75



LEATHER PRUNING GLOVES

Parcel Post Weight, 1 lb. per pair.

No. 216.	Horsehide, with gauntlets, lined.	\$2.25
No. 66.	Horsehide, with gauntlets, not lined.	2.00
No. 62.	Buckskin, with gauntlets, not lined.	3.00

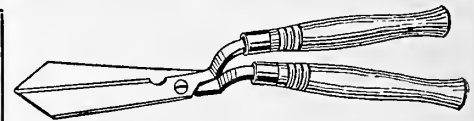

HEDGE SHEARS

No.	P.P.Wt.	Amer.	Eng.
101A 6½-inch Ladies'	4 lbs.	\$1.50	
101A 8-inch	4 lbs.	2.50	\$3.25
101A 9-inch	5 lbs.	3.00	3.50
101A 10-inch	5 lbs.	3.25	4.00
101A 12-inch	6 lbs.	4.00	4.50

Bolts and Nuts for hedge shears, 25c.
Handles for Hedge Shears, 75c. per pair.

NEVERSLIP HEDGE SHEARS

8-inch	\$2.50	10-inch	\$3.00
9-inch	2.75		

YEAKLE HEDGE SHEAR

These shears will not push the hedge forward but will hold it and cut it at once. They also have a tension spring to keep the blades together, consequently need little or no attention, as the spring has a tendency to keep them sharp. Price, \$7.00.

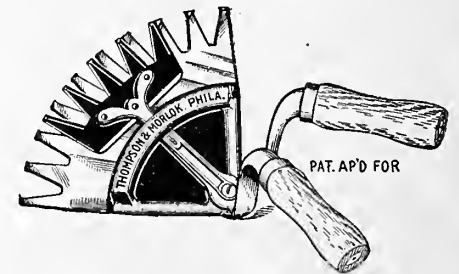

THE UNIQUE HEDGE TRIMMER

Designed to cut the new growth of privet hedge; is double acting, cutting in both directions, backward and forward; used with remarkable ease and rapidity, cutting much quicker than the ordinary hedge shears. Don't expect this shear to cut heavy wood on hedge plants as it is not intended for this purpose; keep it clean and well oiled when using. Price, \$7.50. P. P. Wt., 6 lbs.

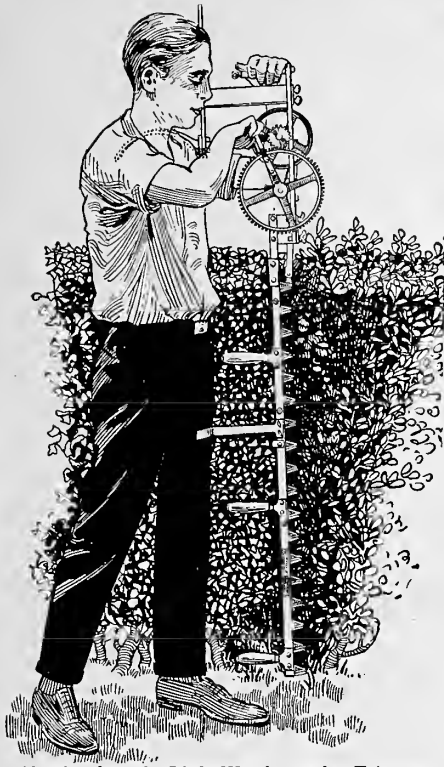

Showing how the Little Wonder Hedge Trimmer works in a vertical position

LITTLE WONDER HEDGE TRIMMER

This machine is built along the most practical lines mechanically, and of the very best materials; weight 16 lbs. When the knives require sharpening, do not grind, use a carborundum stone which accompanies each machine. This trimmer is designed only for trimming back the new growth of hedge during the summer months; it is not intended for cutting back old wood growth; the machine is equipped with a wide web strap for supporting it from the shoulder when in use. The cutting knife runs backward or forward through a knife guard and is operated by turning a wheel. Price, 40 in. cut, \$30.00.

Little Wonder, Jr. Price, 30 in. cut, \$25.00.

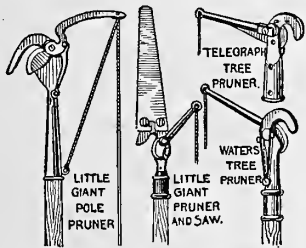

TREE PRUNERS

Disston's Little Giant. Pruner...\$2.25
Parcel Post Weight, 3 1/2 lbs.

Disston's Little Giant. With saw attachment... 2.75
Parcel Post Weight, 4 lbs.

Prices are for Pruner without rope or pole.

TELEGRAPH TREE PRUNERS

Removable blade, which can be renewed when worn out for 25c. Price, plain, without pole, \$2.00. Parcel Post Weight, 2 lbs.

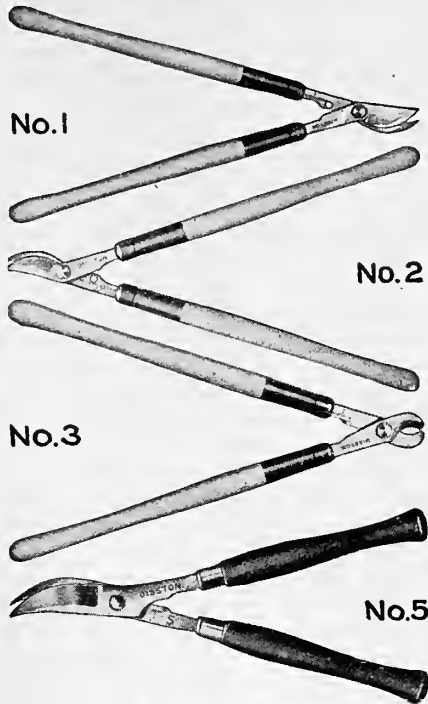

LOPPING SHEARS

No. 1. Disston Lopping. Polished hardwood handle, 27 1/2 inches long; heavy ferrule; heavy blades for heavy work; new tension and positive adjustment; weight, 3 1/4 lbs. Price, \$2.75.

No. 2. Disston Vine Lopping. Details same as above, excepting it is made slightly lighter for smaller work; weight 3 lbs. Price \$2.50.

No. 3. Disston Bull Dog Lopping. Both jaws curved and both cutting jaws; weight 3 1/2 lbs. Price, \$2.50.

No. 5. Disston Utility Lopping. 9-inch black handles; full polish, 3 1/4-inch blades; weight 1 1/4 lbs. Price, \$2.00.

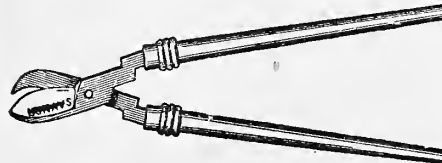

No. 109. English Lopping Shears. 4-inch cut; made of the finest English steel; has great cutting power; will sever heavy branches readily (see cut). Price, \$6.50.

WATERS TREE PRUNERS



With removable cutting blade and pole complete.

- 4 feet.....\$2.25
- 6 feet..... 2.75
- 8 feet..... 3.00
- 10 feet..... 3.50
- 12 feet..... 3.75
- 14 feet..... 4.25

Extra Blades for Waters Pruners, 35c. each.

The Waters Tree Pruners are equipped with poles.

Waters Pruners are not mailable.

Poles for Tree Pruners

- 12 feet long.....\$2.25
- 14 feet long..... 2.50

McKENNEY TREE PRUNER AND LOPPING SHEAR



McKenney Pruner

Designed and built to meet the requirements of the professional fruit growers of America. The makers claim for the "McKenney" Pruner, the easiest cutting pruner in the world. One that does not injure the bark in any way, as both blades have cutting edges; the only pruner that will cut seasoned limbs 1 1/2 in. in diameter; the lightest pruners on the market. Made of steel throughout; nothing about

them to break. The blades are dropped forged from the bar steel and therefore are as strong as they can possibly be made. These handles are of steel; the handgrip is designed so that the pruner may be carried on the belt.

No. 1. Cuts limb up to 1 inch in diam.; weight 2 lbs.; 23 inches long, \$4.50.

No. 2. Cuts limb up to 1 1/2 inch in diam.; weight 5 lbs.; 30 inches long, \$6.50.

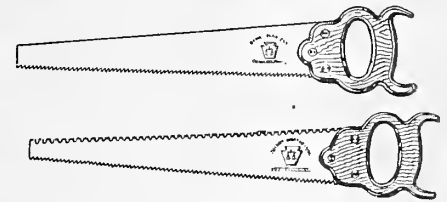

DISSTON PRUNING SAWS

	P.P.Wt.	Each
No. 40. 18-inch. Avery double edge.....	2 lbs.	\$1.25
No. 40. 20-inch. Avery double edge.....	2 lbs.	1.35
No. 7. 16-inch. Single edge.....	2 lbs.	1.60
No. 7. 18-inch. Single edge.....	2 lbs.	1.70
No. 7. 20-inch. Single edge.....	2 lbs.	1.80
No. 7. 22-inch. Single edge.....	2 lbs.	1.90

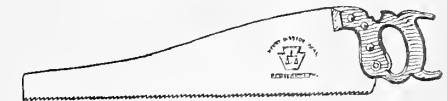

CARPENTER SAWS

State if rip or cross-cut is wanted.
Disston No. 8D. 26-inch blade.....\$3.50
Disston No. 8D. 28-inch blade..... 4.00

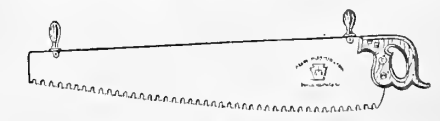

CROSS CUT LOG SAWS

Disston Make.
Keystone No. 3, one-man, 3 1/2 ft. blade.\$3.75
Gt. American, two-man, 5 ft. blade.... 6.00



GRAFTING WAX

¼ lb., 15c.; 25c. per ½ lb.; 1 lb., 45c.

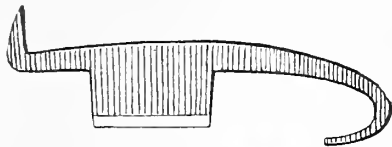

GRAFTING TOOL

Made of the best steel. For grafting trees, etc.
All steel. P. P. Weight, 1lb.....\$1.00

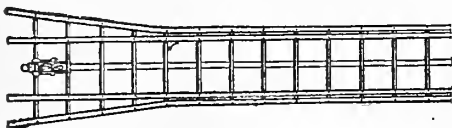

EXTENSION LADDERS

These are made in the best manner possible; are complete, being equipped with the necessary rope and pulleys.

16 feet.....	70c.	26 feet.....	75c.
18 feet.....		28 feet.....	
20 feet.....	per ft.	30 feet.....	80c.
22 feet.....		32 feet.....	
24 feet.....		34 feet.....	per ft.

SINGLE PLANK LADDERS

Made of good hard wood, free from faulty knots and with perfect rounds.

10 feet.....\$5.50	16 feet.....\$8.80
12 feet.....6.60	18 feet.....9.90
14 feet.....7.70	20 feet.....13.00

STEP LADDERS

Gem. 4 ft. to 10 ft., 65c. per foot.

BUCK SAW
Each.....\$2.00

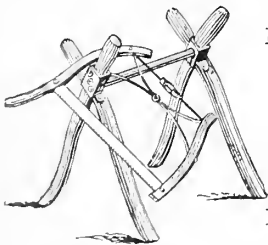

SAW-HORSE OR WOOD BUCK

Each.....\$1.00

RUBBISH CONSUMERS

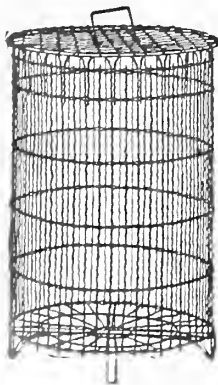

Made of galvanized wire; an indispensable arrangement for burning rubbish, paper, leaves, etc., without endangering property.

Light Wire

No. 1, 14x20 in..	\$1.75
No. 2, 15x24 in..	2.75
No. 3, 18x30 in..	3.00
No. 4, 20x35 in..	4.00

Extra Heavy Construction

No. 10, 16x22 in..	\$11.00
No. 20, 20x30 in..	16.00

MAN O' WAR WINDMILL



able birds or animals. They can be fastened to any tree, post, house or wash line pole.
P. P. Wt., 3 lbs. Height, 15 in., \$1.50 each.

An interesting feature for the children's garden, although they are equally practicable for the grown-ups. They revolve with the least puff of wind, and on account of their looks they serve as a scarecrow for undesirable

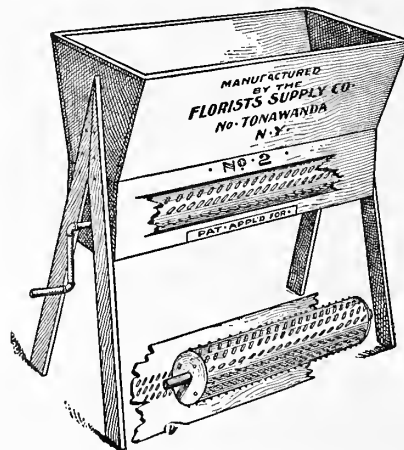

SOD CRUSHER AND SOIL PULVERIZER

These machines are equipped with a hopper and a roller, the latter being spiked. It is turned by means of a handle and crushes the soil perfectly, avoiding the necessity to sift.
No. 1, \$22.50 | No. 2, \$34.00 | No. 3, \$45.00

Our Garden Tool and Sundries Department we believe to be the most fully equipped of any seed store in the United States. Most every article of real merit for horticultural work will be found here, and of best quality.

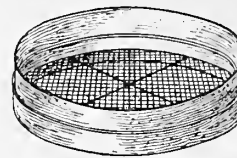

SIEVES

(Any Size Mesh)

Made extra well.

P. P. Wt. Each

20-inch Steel (Heavy).....	\$1.55
20-inch Galvanized wire.....	6 lbs. 1.65
18-inch Galvanized wire.....	6 lbs. 1.50

LARGE UPRIGHT SIEVE

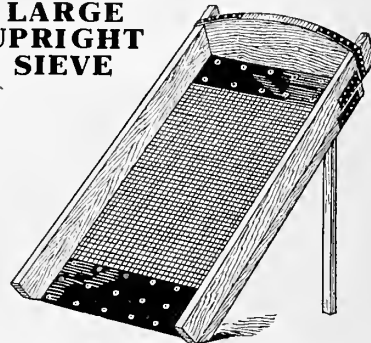

For soil, gravel, sand, etc. Made in any size mesh, of extra heavy grade foundry wire. \$13.50 each.

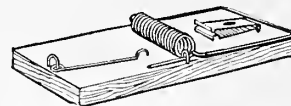

OUT-O-SIGHT TRAPS

The most satisfactory mouse and rat trap. Set off at the least vibration.

	P.P.Wt.	Each
Mouse.....	8 ozs.	\$0.10
Rat.....	1 lb.	.25

THE BALL CELERY BLEACHER

A practical, inexpensive device for bleaching celery early; made of stiff, heavy paper. If the tubes are to be left on the plants all winter and the soil drawn around them, you get celery clean and sweet.

	Per 50	100	1000
No. 1, 6x12 in. Wt. per			
100, 8 lbs.....	\$1.75	\$3.25	\$28.00
No. 2, 6½x13 in. Wt. per			
100, 10 lbs.....	2.25	4.00	35.50
No. 3, 7x14 in. Wt. per			
100, 14 lbs.....	2.50	4.25	37.00

BALL CELERY HANDLER

Brass, \$4.50 each. Tin, \$1.75 each.

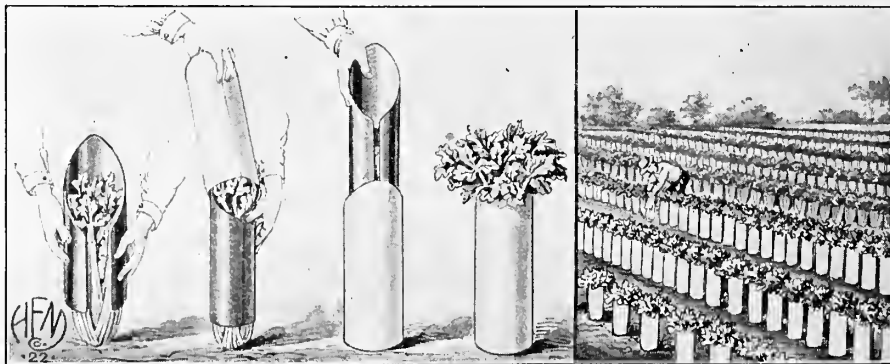

Ball Celery Bleacher

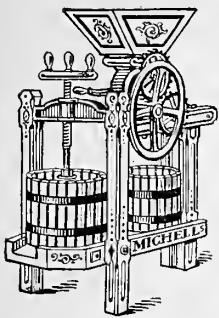

Cider Mill

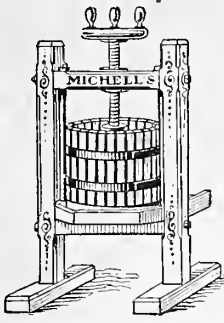

Wine Press

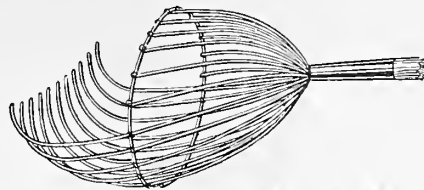

BOSS FRUIT PICKER

Made substantially of galvanized wire. Can easily be attached to a pole of any length. Price, 40c. P. P. Weight, 2 lbs.

MASTERS FRUIT PICKER

Equipped with an attachment for a pole and holding bag; a very desirable type, that will not bruise the fruit. Price, \$1.50.

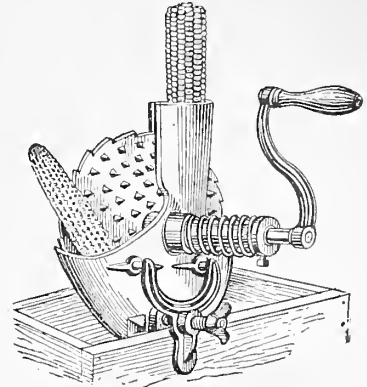

BLACK HAWK CORN SHELLER

Excellent for small poultry farms, etc. Ball-bearing; suitable for fastening to a bench, box, etc., for shelling small quantities of corn. \$3.50 each.

PENNA. CORN SHELLER No. 3

Useful on every farm and private estate. Separates the corn from the cob, throwing the cob to one side and allowing the corn to pass out another. \$16.00.

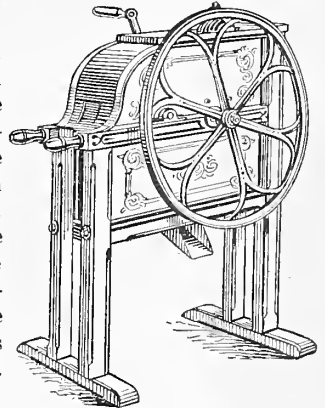

CIDER MILLS

	Capacity	Price
Bantam	1/2 bu.	\$20.00
Junior	5/8 "	30.00
Medium	3/4 "	32.50
Senior	1 1/4 "	45.00

WINE PRESSES

Made of best quality wood, carefully bolted and finished.

No.	Capacity	Price
1	1/4 bu.	\$8.00
2	1/2 "	10.00
3	1 "	14.00

CIDER KEGS

5-gal. cap. \$3.00 | 10-gal. cap. \$3.25

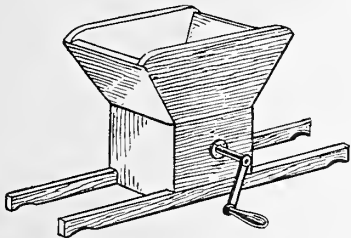

GRAPE GRINDER

Suitable for crushing berries, grapes and similar soft fruit.

No. 5	\$5.00
No. 10	6.00



JUICY FRUIT PRESS

A very valuable press for making Jellies, Fruit Syrups, Lard, etc. All parts coming in contact with fruit juices are tinned with pure block tin. Base and feet cast as one piece. Price, \$8.00.

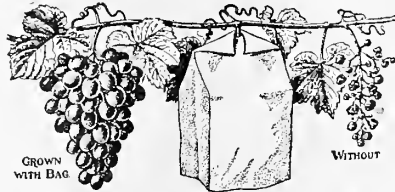

GRAPE PROTECTING BAGS

Thousands of bunches of grapes are wasted annually because they are not protected against the ravages of insects, birds, etc. Michell's Improved Grape Bags are economical, easily attached and last a season. The fruit ripens just as readily in them as it does in the open. The bags should be attached when the grapes are the size of a pea prior to which it is suggested that they be sprayed (even though not affected) against blight or fungus; the bags should be left attached until the fruit is ready to harvest. If desired by mail please add to the prices below as noted.

	Weight per 100	100	1000
2 lb. size	1 1/2 lbs.	\$0.60	\$5.00
3 lb. size	1 1/2 lbs.	.70	5.75
4 lb. size	1 1/2 lbs.	.75	6.50



WATER SEAL CANNER

Put up your own Vegetables and Fruits with an Improved Water Seal Canner. It gives the necessary rapid application of heat, and maintains it uniformly as long as required. Insures canned fruits and vegetables that retain their natural color, delicious flavor, rich food value and firmness. Strongly built of galvanized iron, with brass fittings. The Water Seal Canner is portable and adapted to kitchen stove, gas range or open fireplace.

No. 1, capacity, 13 one-quart glass jars, or 17 three-pound cans, \$12.50 each.
No. 7, capacity, seven one-quart glass jars or 10 one-pint glass jars, \$7.00 each.

Our Garden Tool and Sundries Department we believe to be the most fully equipped of any seed store in the United States. Most every article of real merit for horticultural work will be found here, and of the best quality.

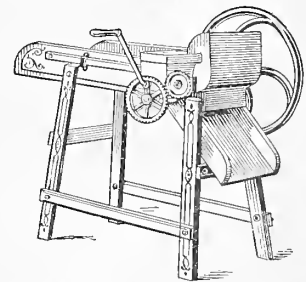

HAY AND FEED CUTTER

For cutting hay, ensilage, etc. Triumph. Double knife \$20.00

BANNER ROOT CUTTER

Roots of vegetables cut up fine take the place of grass and greens during the winter months.

No. 7. For poultry, sheep and lambs, \$6.50.
No. 16. Medium size, \$22.50.
No. 35. Large size, \$30.00.
If pulley is wanted on Nos. 16 and 35, add \$1.50.

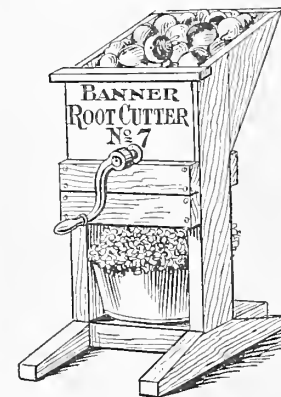

PRESTO FRUIT PRESS

Used for extracting juices from Berries, and other Fruits. Made entirely of iron and steel; all parts heavily tinned.

No. 1. 3 quart size	\$6.00
No. 2. 6 quart size	10.00
No. 3. 9 quart size	12.00

MICHELL'S LAWN, GARDEN AND FARM ACCESSORIES

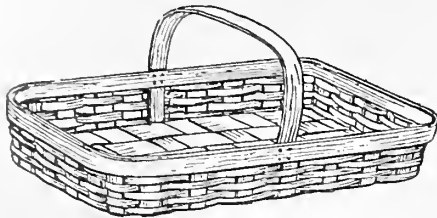

GATHERING BASKET

Very convenient for carrying berry boxes, asparagus and other vegetables. Made of oak, with double collapsible handles; 12 in. wide, 23 in. long, 4 in. deep. Price, \$1.25.



GARDEN BASKETS

- No. 2, Stiff Handle
Each \$1.00
1/2 Bu. \$1.00
- No. 3, Drop Handle
Each \$1.00
1/2 Bu. \$1.00
- No. 4, Without Handle
Each \$1.00
1/2 Bu. \$1.00
1 Bu. 1.25



SPLIT OR CHIP BASKETS

Without Handles		With Handles	
	Each Doz.		Each Doz.
1/4 bu...	\$0.12 \$1.40	1/4 bu...	\$0.15 \$1.50
1/2 bu...	.18 1.60	1/2 bu...	.20 1.75
3/4 bu...	.20 2.00	3/4 bu...	.25 2.25
1 bu...	.35 3.75	1 bu...	.40 4.00

Please note our present supply of handled splint baskets are double, drop style.

BERRY BOXES



P. P. Wt.	
Doz.	1000
1 qt. 2 lbs.	\$1.50 \$12.00
1 pt. 1 lb.	1.35 11.00

WOOD MEASURES

- 1/4 peck \$0.75
- 1/2 peck80
- 1 peck 1.10
- 1/2 bushel 1.75
- 1 bushel 3.00

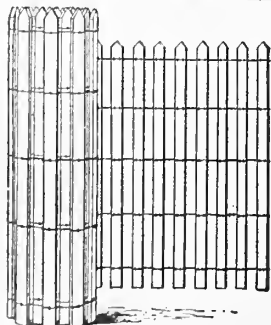
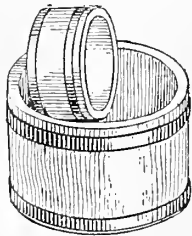

CEDAR PICKET FENCING

See description and price opposite column.

WIRE NETTING

Price is constantly changing and is subject to change.

No. 19. Galvanized, two-inch mesh, 150 running feet per bale.

Width	Per Bale	Width	Per Bale
12 inches \$1.68	42 inches \$4.88
18 inches 2.40	48 inches 5.58
24 inches 3.00	60 inches 6.88
30 inches 3.68	72 inches 8.37
36 inches 4.19		

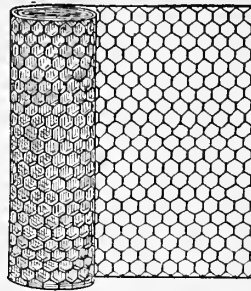

No. 20, galvanized, one-inch mesh, 150 running feet per bale.

Width	Per Bale	Width	Per Bale
12 inches \$3.36	42 inches \$9.75
18 inches 4.80	48 inches 11.15
24 inches 6.00	60 inches 13.00
30 inches 7.32	72 inches 15.60
36 inches 8.37		

STAPLES

3/4 inch, for fastening netting, 15c. per lb.

CUT WIRE NETTING

We furnish this in both 1- and 2-inch mesh, in units of 25-ft., 50-ft., 75-ft., 100-ft. and 125-ft. lengths. 1-inch mesh at 4c. per square ft.; 2-inch mesh at 2c. per square ft.

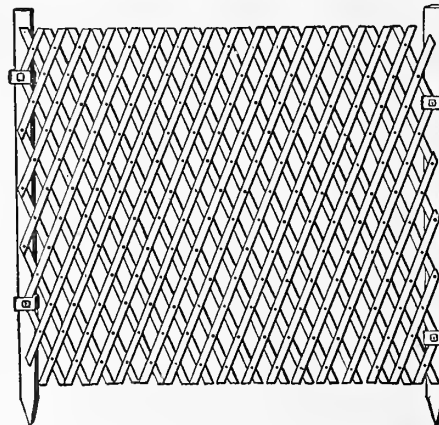

No. 1, MANIFOLD PEA TRELLIS (Wood)

The ideal arrangement for garden and sweet peas. When fully opened it makes a trellis 19 feet long, and this is varied according to the height desired. Positively the best thing of its kind that has ever come to our notice. It can be set up in 5 minutes and taken down in less; folds together so that it occupies very little storage space. Very desirable also as a trellis for training vines on. Complete ready to put up; stained green, \$3.25 each; doz., \$37.50.

CEDAR PICKET FENCING

This is tailor-made compared to the ordinary ready-made fencing. Will wear for years without paint. Readily put up and saves time, labor and expense of fence building. Far ahead of and will outwear the old style wire fence by many years. Rolls of 50, 75 and 100 feet only.

3 ft. high, with 4 galvanized steel double wire cables, 14c. per running foot.

4 ft. high, with 5 galvanized steel double wire cables, 16c. per running foot.

5 ft. high, with 6 galvanized steel double wire cables, 21c. per running foot.

See illustration, opposite column.

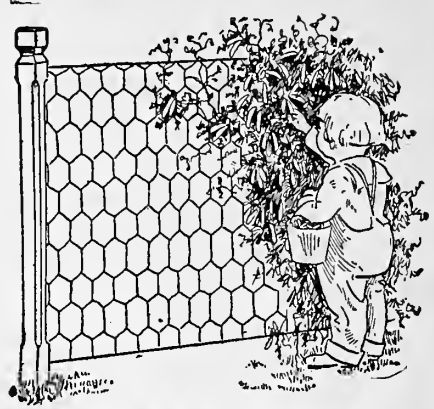

WIRE PEA TRELLIS

Does away with brush, twine, etc., and avoids the necessity of peas lying on the ground and wasting; made of best wire and painted wood. It is 48 inches high and in 10-foot sections, with 3 suitable 5 1/2-foot stakes for fastening in the ground. \$1.75 each.

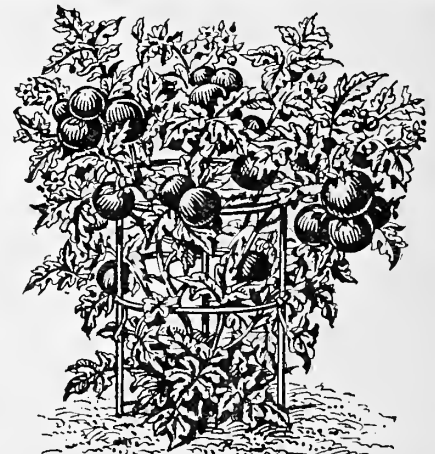

TOMATO OR PAEONY SUPPORT

These pay for themselves the first season. They insure more flowers and better fruit. Model (Wire). Each, 35c.; doz., \$3.50; \$24.00 per 100.

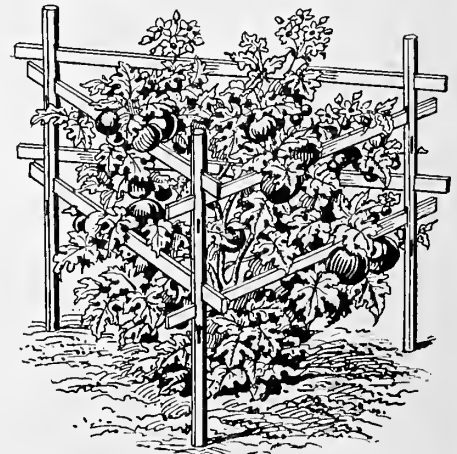

TRIANGO PLANT SUPPORT

Can be used for Tomatoes, Beans, Peas and other plants. Hexagonal hard wood slats, stained green, which fit into the mortised slots in the stakes, making it possible to arrange in lineal, triangular, or square form, or the stakes can be used alone. 25c. each; doz., \$2.75.

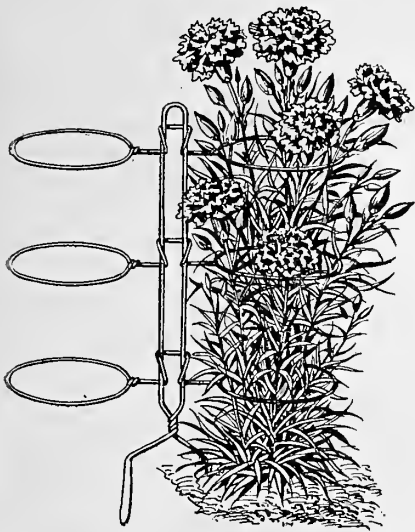

CARNATION SUPPORTS

The Richmond shown is the most popular support on the market. Can be put together in a minute and is always satisfactory; 24 inches high.

Richmond, double		
Doz.	100	1000
\$1.50	\$7.50	\$67.50
Richmond, single		
Doz.	100	1000
\$1.25	\$6.75	\$62.50
Model, 2-ring		
Doz.	100	1000
\$1.00	\$6.50	\$60.00
Model, 3-ring		
Doz.	100	1000
\$1.25	\$7.00	\$65.00

ADJUSTO PLANT SUPPORT

Indispensable for Roses, Dahlias, Tomatoes and other plants.

The "Adjusto" Plant Support is a marvel for simplicity and efficiency. It consists of two parts, an oak stake pointed at the bottom and painted green, and a hoop of the toughest wire, also painted green to prevent rust.

It contains no nails, hooks, or screws. It holds securely any flower or plant and can be adjusted to any height to conform with the plant's growth.

For all-round garden use and as permanent equipment the "Adjusto" Plant Support can't be touched by anything on the market either in respect to cost or the way they do the work. And then they save the time and labor you otherwise would spend on inefficient equipment. Plants thrive when supported by the "Adjusto" and are sure to bear more beautiful blossoms and perfect fruit.



A permanent equipment which can be used year after year.

Height	Each	Doz.
18 inch...	\$0.10	\$0.85
24 inch...	.12	1.00
3 feet...	.15	1.75
4 feet...	.25	2.25
5 feet...	.30	2.50
6 feet...	.35	3.25

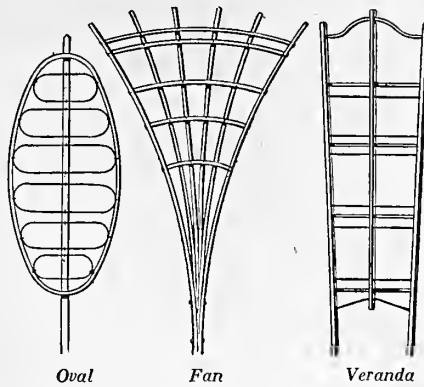

VERANDA TRELLIS

Made of wood and painted green.

2 feet.....	\$0.90	6 feet, heavy.	\$2.50
3 feet.....	1.35	8 feet, heavy.	3.25
4 feet.....	1.50	10 feet, heavy.	3.75
5 feet, heavy..	2.25	12 feet, heavy.	4.50

FAN TRELLIS

Made of wood and painted green.

18 inch.....	\$0.40	36 inch.....	\$1.35
24 inch.....	.50	42 inch.....	1.55
30 inch.....	.80	48 inch.....	2.00

OVAL TRELLIS

Made of wood and painted green.

24 inch.....	\$0.60
--------------	--------

LATTICE TRELLIS

Made of wood and painted green.

		18 in. wide	24 in. wide
6 feet.....	\$2.50		\$3.00
7 feet.....	3.00		3.75
8 feet.....	3.25		4.25
9 feet.....	3.50		4.50
10 feet.....	4.00		5.00
12 feet.....	4.50		6.00

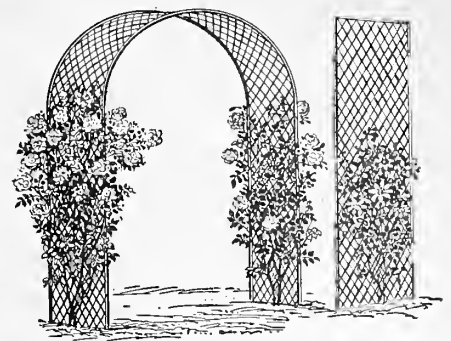

GALVANIZED WIRE WORK

This can be furnished on short notice, any height or any width, in either trellises or arches. Made of heavy diamond mesh wire with strong frames. It requires usually several weeks in which to complete orders for this. 45c. per sq. ft. on pieces aggregating 10 sq. ft. or over; less than 10 sq. ft. pieces, 50c. per sq. ft.

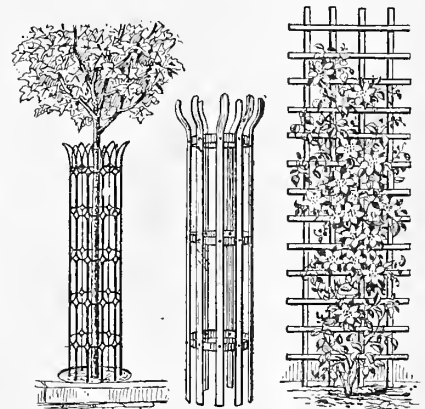

Wire Guard Iron Guard Lattice Trellis

TREE GUARDS

Galvanized Wire. Carefully made of heavy material and finished in a neat and substantial manner. 12 in. diam., \$3.75; 9 in. diam., \$3.00 each.

No. 4 Iron. Made of flat iron, finished black; will last indefinitely with an occasional painting. \$3.75 each.

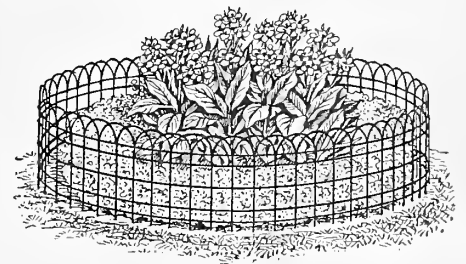

FLOWER BED FENCING

For putting around beds, lawns, etc. Any length desired up to 165 running feet.

18 in.	Less than 165 ft. roll, 15c. per ft.
18 in.	In roll lots, 165 ft., 12c. per ft.
24 in.	Less than 165 ft. roll, 17c. per ft.
24 in.	In roll lots, 165 ft., 15c. per ft.

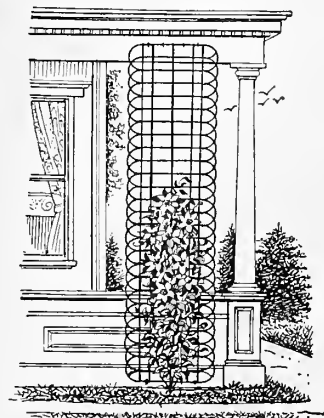

CONTINUOUS WIRE TRELLIS

Excellent for training vines of all kinds up porch verandas, pergolas, etc. Thoroughly galvanized and well made.

Any length desired up to 165 running feet.

18 in. wide, less than 165 ft. roll,	14c. per ft.
18 in. wide, in roll lots, 165 ft.,	11c. per ft.
24 in. wide, less than 165 ft. roll,	16c. per ft.
24 in. wide, in roll lots, 165 ft.,	14c. per ft.

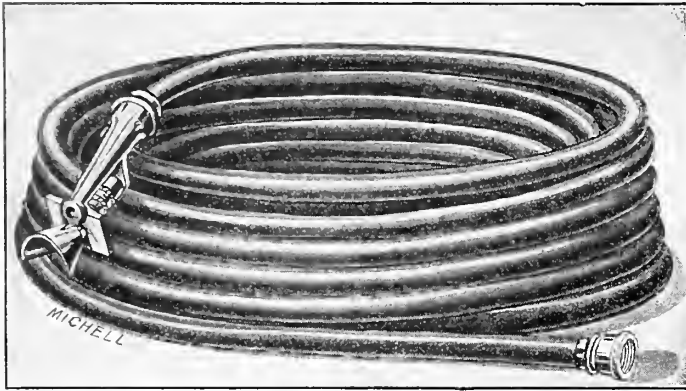

RUBBER HOSE

Special attention is called to "Michell's Akron" Hose, a new brand, which, having been thoroughly tried out, has made good.

- Per Foot.
- *Michell's Special, 1/2 inch \$0.15
 - *Michell's Special, 3/4 inch18
 - *Michell's Magic. A splendid smooth finish, red hose; 3/4 inch22
 - *Michell's Akron. Flexible, durable, uninkable, 3/4 inch21
 - *Electric, 3/4 inch22
 - *Electric, 1/2 inch20
 - *Whip-Cord, 3/4 inch18
 - Spray Pump Hose, 3/8 inch16

P. S.—Brands marked * come in reels of 500 feet and sections in any length to that number of feet may be had.

25- and 50-foot sections of hose coupled free. Smaller sections coupled at the rate of 35c. per pair for couplings.

Hose Washers. 3/4 inch and 1 inch, price either size, 8c. per doz.; 1/4 lb., 30c.; \$1.00 per lb.



Caldwell Band as applied to Hose

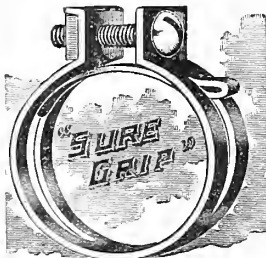

HOSE BANDS

For fastening couplings and menders.

CALDWELL'S

- | | | |
|------------------------|--------|--------|
| No. | Doz. | Gross |
| 8. For 4-ply hose..... | \$0.40 | \$3.50 |
| 6. For 3-ply hose..... | .40 | 3.50 |
- Parcel Post Wt., doz., 1/4 lb.; 100, 2 1/4 lbs.

SURE GRIP

Can be furnished in 1/2-inch, 5/8-inch and 3/4-inch, either size, 6c. each; doz., 60c. Parcel Post Wt., doz., 1 lb.; 100, 9 1/2 lbs.

HYDRANT ATTACHMENTS

For attaching hose to smooth faucets. No. 2. For small spigot, 65c.

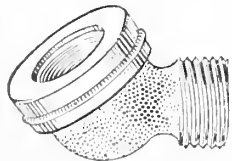

No. 3. For large or standard spigot, 65c. Parcel Post Weight, 1/2 lb. each.

HOSE REDUCERS

For reducing 1-in. pipe to fit regular 3/4-in. hose.

Each \$0.70
Parcel Post Weight, 1 1/2 lbs.

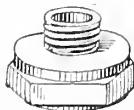

Cooper Hose Mender

HOSE MENDERS

	P.P.Weight	Doz.	Each	Doz.
Cooper's 3/4-inch.....	1 1/4 lbs.	\$0.12	\$1.25	
Cooper's 5/8-inch....	1 lb.	.12	1.25	
Cooper's 1/2-inch....	1 lb.	.12	1.25	
Iron, 3/4-inch.....	2 1/4 lbs.	.10	1.00	

PERFECT HOSE MENDER

Made entirely of brass, with swivel motion—No band required.

For 1/2-inch and 3/4-inch hose, 15c. each;

doz., \$1.50.
Parcel Post Weight, per doz., 1 3/4 lbs.

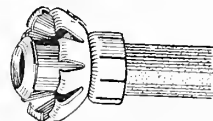

HOSE COUPLINGS

	P.P.Wt.	Doz.	Pair	Doz.
Plain Brass, 1/2 inch..	3 1/4 lbs.	\$0.25	\$2.50	
Plain Brass, 3/4 inch..	.4 lbs.	.25	2.50	

Perfect. Equipped with a clamp on the male and female part for securing to the hose; no band required; for 1/2- and 3/4-inch hose; mention which is wanted when ordering. 45c. per pair; doz., \$5.00.

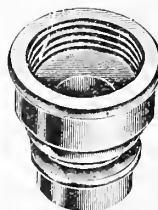

No. 3

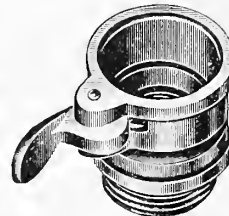

No. 4

ACME HOSE COUPLINGS

For quickly connecting and detaching hose.

No. 3 part, for attaching to spigot, 30c. each; doz., \$3.00. Weight, per doz., 3 lbs.
No. 4 part, for attaching to hose, 50c. each; doz., \$5.00. Weight, doz., 3 lbs.

Couplings complete, consisting of one No. 3 and one No. 4 part, 80c. each; per doz., \$8.00. Weight, per doz., 6 lbs.

HOSE REELS



Meon Hose Reel

Meon. Made entirely of steel; very strong; easy to operate, the reel acting both for winding and wheeling.

- No. A1. 90 ft. capacity.....\$3.50
- No. A2. 130 ft. " 4.00
- No. A3. 180 ft. " 4.50

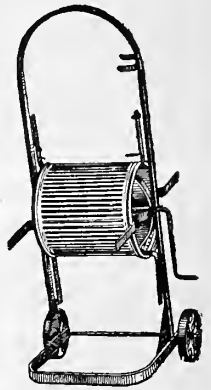

Victor Reel

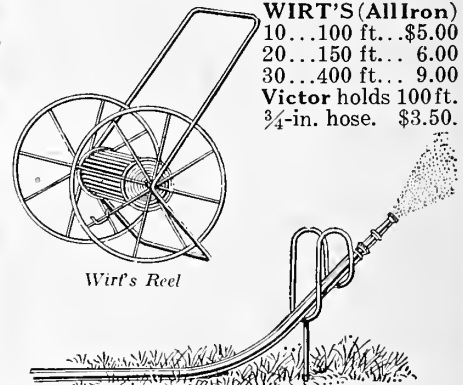

Wir's Reel

WIRT'S (All Iron)
10...100 ft...\$5.00
20...150 ft... 6.00
30...400 ft... 9.00
Victor holds 100 ft.
3/4-in. hose. \$3.50.

NOZZLE HOLDER

For sticking in the ground while one continues with other work. Made of galvanized heavy wire. Price, 25c. each.

Parcel Post Weight, 8 ozs.

PATENTED IN UNITED STATES AND FOREIGN COUNTRIES

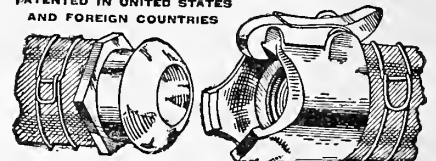

No. 2 Snap Coupling No. 1 Snap Coupling

SNAP HOSE COUPLINGS

Snap Couplings are entirely new and novel. They couple hose instantly, work on a spring, and are water-tight. 35c. per pair; doz. pairs, \$3.75. Washers, 20c. per doz. Parcel Post Weight, per doz., 2 1/2 lbs.

SNAP COUPLING PARTS

No. 2. Male. 15c. each; per doz., \$1.50. Parcel Post Weight, per doz., 1 1/4 lbs.
No. 1. Female. 25c. each; per doz., \$2.50. Parcel Post Weight, per doz., 1 1/4 lbs.

No. 68 SIAMESE HOSE CONNECTION



This permits one lead of hose to be diverted in two directions. Additional three-way connections can be used according to the water pressure. It is specially adapted for lawn sprinkling. Price, 75c. each.

Parcel Post Weight, 1 lb.

BINKS NOZZLE

Made of aluminum, with brass face; equipped with interchangeable sprays, coarse and fine. It makes watering possible without wetting the hands. Positively the best and most indestructible nozzle made. \$3.00 each; worth twice the price. P. P. Wt., 1 1/4 lbs.

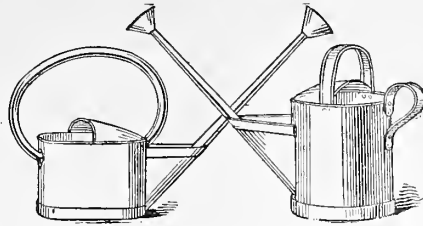
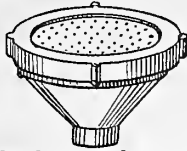

WATER CANS (Wotherspoon's)
Extra Heavy—With Long Spout—Will Last for Years

Each Wotherspoon can comes equipped with two roses, one coarse and one fine. These cans not mailable.

	Round	Oval
4 quart.....	\$3.50	
6 quart.....	3.85	\$4.50
8 quart.....	4.15	4.80
10 quart.....	4.45	5.10
12 quart.....	4.90	5.70
16 quart.....	5.40	6.40
4 quart Fern or Low Watering Can.....	2.75	

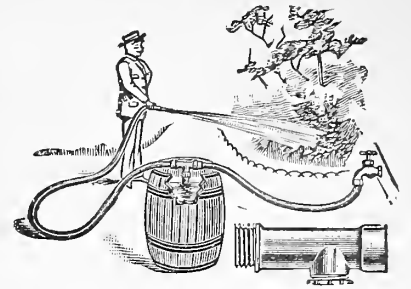

LIQUID MANURE DISTRIBUTOR

This can be attached to hose with which you are watering and, connected with a barrel of liquid manure, the suction of water will draw a quantity of manure with it. \$2.75 each.

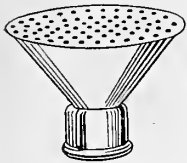

BOSTON SPRAY NOZZLE

(For 3/4-inch Hose)
P.P.Wt. Price
Light Copper... 1/2 lb. \$1.10
Heavy Brass... 1 lb. 1.25

PERFECTION HOSE NOZZLE

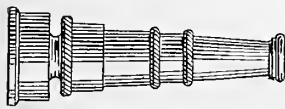

3/4-inch hose. Can be regulated to give three different streams. Price, 75c. Weight, 1/2 lb.

Allen. Similar to the Perfection nozzle. Parcel Post Weight, 1/2 lb. Price, 70c.

Rose. Useful for watering lawn and garden. Parcel Post Weight, 1/2 lb. Price, 40c.

Champion. A dandy nozzle for greenhouse use; makes a spray or a solid stream; easily adjusted. P. P. Wt. 1/2 lb., 75c. each.

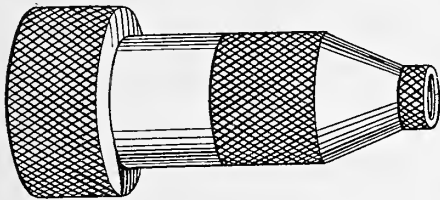

RAINBOW NOZZLE

Makes a full stream or fine spray, which can be changed by a slight turn of the finger; positive shut off; no leaks; nothing to wear out. P. P. Wt. 1 lb. Price, \$1.00.

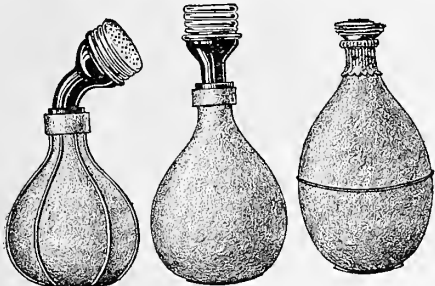

Spraywell

Scollay

RUBBER SPRINKLERS

Either Straight Neck or Crook Neck.
Spraywell, 6-oz. cap. Wt. 8 ozs.... \$0.85
" 8-oz. cap. Wt. 1 lb.... 1.00
" 10-oz. cap. Wt. 1 lb.... 1.25
Scollay No. 1, 10-oz. cap. Wt. 1 lb.. 1.50

RUBBER APRONS

For watering, etc., made of extra heavy material; brass eyelets. \$2.50 each.

EXTRA ROSES OR SPRAYS

For Wotherspoon Watering Can, either coarse or fine, 50c. each. Parcel Post Weight on roses, 8 ozs.

IRON CLAD WATER CANS

Made of light galvanized iron.

4 quart.....	\$1.00
6 quart.....	1.15
8 quart.....	1.30
10 quart.....	1.55
12 quart.....	1.65
16 quart.....	2.10

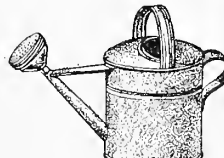

Iron Clad

DOUBLE ROTARY SPRINKLER

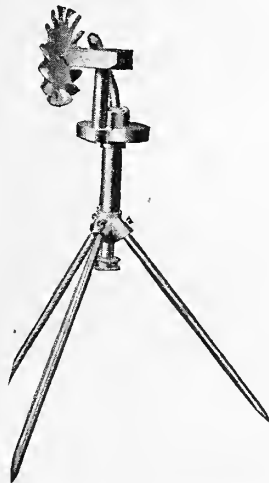

See page 171 for complete line of sprinklers

HOME CHERRY STONER

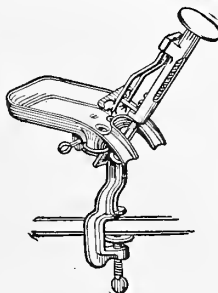

Removes the stone without crushing the cherry; two cherries are pitted with each downward thrust of the handle which forces plungers through the cherries and at the same time forces the stones below. Price, \$1.00 each.

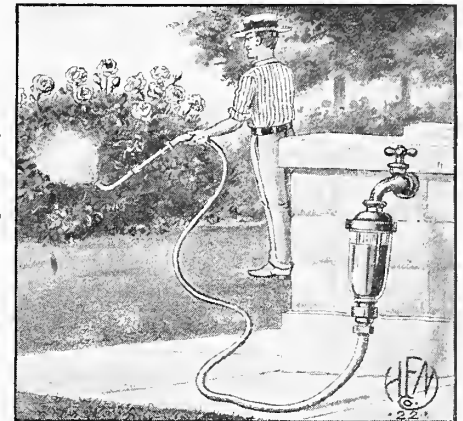

Houghton Sprayer

HOUGHTON SPRAYER

A device for attaching to the water line spigot for distributing in a highly efficient manner modern greenhouse insecticides; the sprayer can also be attached to a force spray pump by means of an interchangeable ferrule, 1/2 and 3/4-inch. The illustration shows a substantial sized glass reservoir into which a cartridge of insecticide as offered below is put, the water is turned on at the faucet after the hose is attached and you have one of the most perfect systems of applying insecticides to plants either under glass or out of doors; a branch pipe with nozzle which is part of the equipment is put on the nozzle end of the hose and the preparation to be used is applied under reasonably high pressure, because the nozzle is so designed. Price of Nozzle, pipe and reservoir with interchangeable ferrules, \$6.75.

Price List and Varieties of Cartridges:

	Each	Doz.
Arsenate of Lead.....	\$0.60	\$6.50
Hellebore (Petroleum).....	.60	6.50
Arsenate of Lead and Fish Oil (Comb.).....	.60	6.50
Fish Oil.....	.60	6.50
Fish Oil and Nikoteen.....	.60	6.50
Caustic Petroleum.....	.60	6.50
Bordeaux and Fish Oil.....	.60	6.50

PARCEL POST SHIPMENTS

Where goods can be shipped in this manner, we have affixed the packed weight opposite. Where remittance accompanies order please include sufficient to cover mailing charges. Consult parcel post table on page 1 for proper amount.

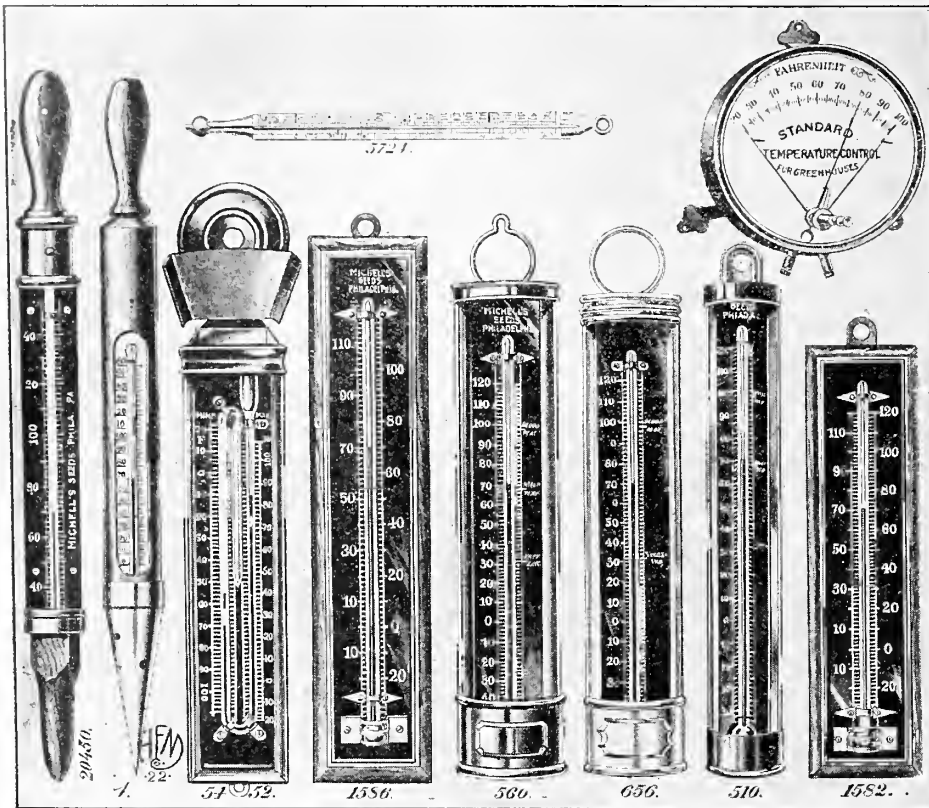

THERMOMETERS

No. 5452. Maximum and Minimum. Registering the coldest and the warmest point during the previous night. 8-inch, each, \$5.00.

TESTED THERMOMETERS

- | | | |
|--|------|--------|
| No. 556— 8 inch, Tin Case | Each | \$1.00 |
| No. 560—10 inch, Tin Case | | 1.25 |
| No. 506— 8 inch, Greenhouse | | .75 |
| No. 510—10 inch, Greenhouse | | .85 |
| No. 652— 8 inch, Genuine Copper Case | | 1.75 |
| No. 656—10 inch, Genuine Copper Case | | 2.25 |
| No. 1582—8 inch, Wood Back, Black Scale | | 1.50 |
| No. 1586—10 inch, Wood Back, Black Scale | | 1.75 |

GLASS DAIRY THERMOMETERS

No. 5724. For testing milk, etc., also used for soil purposes. 60c. each.

MUSHROOM OR HOTBED THERMOMETERS

- | | |
|--|--------|
| No. 20450. Galvanized Iron Point, each | \$2.00 |
| No. 1. Brass Point, Paper Scale, each | 1.50 |

ELECTRIC THERMOSTAT

This device can be set to ring an alarm when the temperature goes above or drops below a desired point. All brass. Not waterproof style, \$11.50; waterproof style, \$17.50. See illustration above.

RECORDING THERMOMETER

This type of thermometer which can be equipped with either a daily or weekly chart enables one to keep an accurate record of the temperature in his greenhouse during every hour of the day and night; the thermometer is equipped with a high grade clock and ink stylus which marks very accurately. It is an ideal installation; in ordering state if weekly or daily record chart is desired. Price, \$45.00.

PEERLESS REPAIR CLAMP



GLASS CLAMPS

For supporting broken lights of glass. Per box of 100, \$1.75. P. P. Wt., 1 1/4 lbs.

TWEMLOW'S PUTTY

Superior to ordinary putty, more easily applied and lasting. Can be put on with a putty bulb or mastic machine.
 16-lb. can (1 gal.) P. P. Wt., 18 lbs.... \$2.75
 80 lbs. (5 gals.)..... 13.50
 160 lbs. (10 gals.)..... 26.50

MASTICA

For glazing greenhouses. One gallon will cover about 300 running feet.
 1 gallon..... P. P. Wt., 15 lbs. \$2.50

HAMMOND'S GREENHOUSE WHITE

A superior white paint for sash bars, sash frames, etc. Per gal., \$4.25.

MASTICOTE GLAZING CEMENT (Black)

For waterproofing greenhouse gutters, roofs, etc., apply with a mastic machine.
 1 gal., \$2.25; \$10.75 for 5 gals.

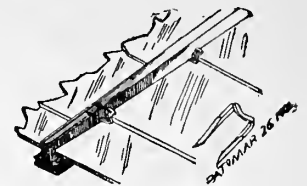

Peerless Glazing Point

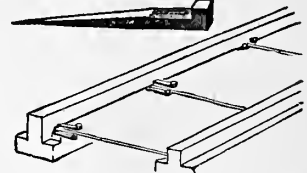

Siebert Glazing Point

GLAZING POINTS

- Peerless.** Three sizes.
 No. 1, for single thick glass.
 No. 2, for single thick glass.
 No. 2 1/2, for double thick glass.
 Price, 65c. per 1000. By mail, 10c. per 1000 extra.
- Pincers.** For driving Peerless Points, 60c. By mail, 65c.
- Siebert Style.** Made with a prominent head; cannot rust; easily driven. 5/8, 3/4 and 1/8 inches long. Zinc, 60c. per lb.; 5 lbs., \$2.75. 1000 to 1200 in a lb.
- Zinc Glazing Nails.** 50c. per lb.; 5 lbs., \$2.40.



GLASS CUTTERS

- | | |
|--|--------|
| Single Wheel, steel, each | \$0.25 |
| 6-Wheel, steel, each | .60 |
| No. 8 Small Diamond (Ebony handle) | 4.50 |
| No. 8A Large Diamond (Mahogany handle) | 5.75 |

PUTTY DISTRIBUTOR

For distributing putty, mastic, etc. Price, \$1.50. Parcel Post Weight, 1 lb.

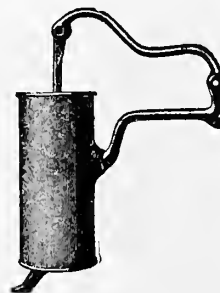

Mastica Machine



Putty Distributor

MASTICA MACHINE

For distributing mastic, etc. Made of heavy zinc. Price, \$3.00. P. P. Wt., 2 lbs.

PARCEL POST SHIPMENTS

Where goods can be shipped in this manner, we have affixed the packed weight opposite. Where remittance accompanies order please include sufficient to cover mailing charges. Consult parcel post table on page 1 for amounts.

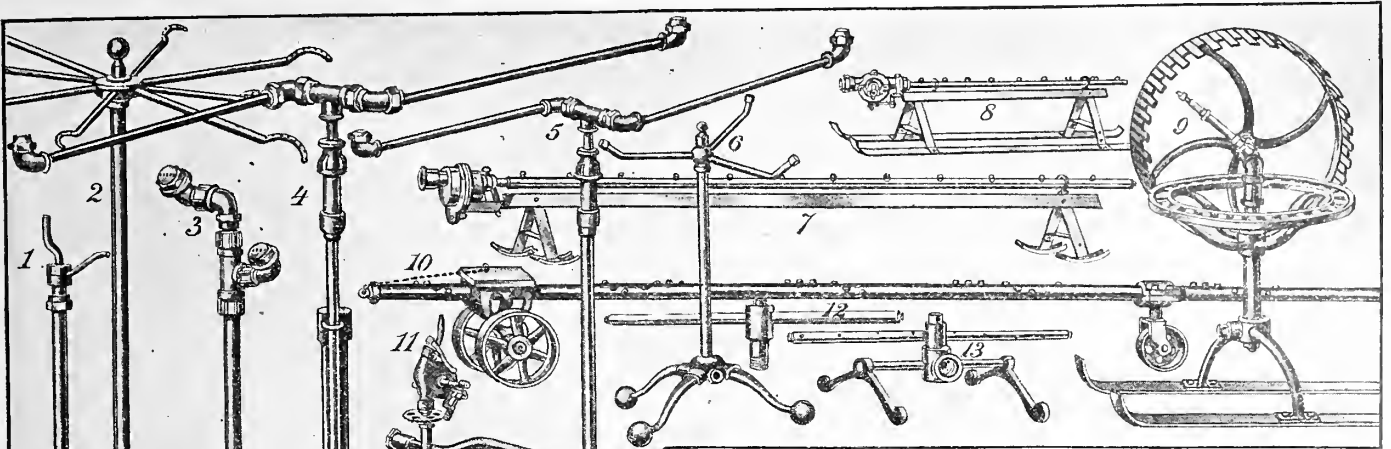

Our stock of lawn sprinklers is quite extensive and we are sure we can meet most all requirements.

- | No. | Price |
|--|--------|
| 1. Cico Automatic. Covers an area 30 inches in diam.; price with 18 in. stand pipe, \$5.00; head only..... | \$3.50 |
| 2. Peck 8 Arm. For smaller yards, height 48 inches; weight 14 lbs..... | 5.00 |
| 3. Empire. Height 24 inches, weight 7 lbs., operates best on a pressure of 25 lbs.; it is adjustable to cover an area varying from 40 to 80 ft. in diameter..... | 6.50 |
| 4. Raining No. B. For golf courses, putting greens, 66 in. high, on tripod..... | 20.00 |
| Raining No. A. For golf courses, putting greens, etc. 42 inches high, adjustable stand for uneven ground..... | 15.00 |
| 5. Raining No. C. For golf courses, putting greens, 36 in. high, on stand..... | 12.50 |
| 6. Raining No. D. For golf courses, putting greens, 18 in. high..... | 10.00 |
| 7. Aetna. For lawns, etc., 24 in. high, weight 6¼ lbs..... | 2.75 |
| 8. Water Fan (Cico Oscillating). Small size, 21 in. long, weight 50 lbs.; price, \$15.00; large size, 5 ft. long..... | 25.00 |
| 9. Penna. Rainmaker. 29 in. high, weight 52 lbs. This sprinkler will operate satisfactorily with a pressure of not less than 40 lbs.; covers an area of 60 to 75 ft. in diameter; splendid for very large lawns and golf courses..... | 25.00 |
| 10. Peacock. On truck, 12 ft. long, \$17.50; Peacock Jr. Without truck, 8 ft. long..... | 10.00 |
| 11. Turbo. Complete with stand, \$25.00; without stand..... | 18.00 |
| 12. Rainbow. Standpipe style, for golf courses..... | 1.50 |
| 13. Rainbow. Sled style, for regular lawns..... | 3.00 |
| 14. Waterwitch. Height 6 in., weight 1 lb..... | .60 |
| 15. No. 1 Enterprise. Height 9½ in., weight 10 lbs. This operates best on a pressure of over 25 lbs., covering a diameter of about 12 feet..... | 5.00 |
| 16. Universal. Height 10 in., weight 4¼ lbs..... | 3.00 |
| 17. Pluvius. Height 11 in., weight 3½ lbs..... | 1.75 |
| 18. Crescent. Height 2 in., weight 1 lb..... | .75 |
| 19. Eureka. Height 10 in., weight 4 lbs..... | 2.50 |
| 20. Preston. Height 6½ in., weight 3½ lbs..... | 2.00 |
| 21. Baby Ring. Height 2 in., weight 1 lb..... | .65 |
| 22. Mayflower. Height 12 in., weight 3 lbs..... | 1.75 |
| 23. Large Ring. Height 2 in., weight 2 lbs..... | 1.00 |
| 24. C. B. G. Especially for putting greens, 4 in. high, weight 2 lbs..... | .50 |
| Double Rotary Sprinkler. A favorite with country clubs, for watering putting greens, covering a radius of 15 to 80 ft. according to pressure, requiring only the minimum to operate it..... | 12.50 |

PARCEL POST SHIPMENTS

Where goods can be shipped in this manner, we have affixed the packed weight opposite. Where remittance accompanies order please include sufficient to cover mailing charges. Consult parcel post table on page 1 for proper amount.

RUSTIC FURNITURE, WINDOW AND PORCH BOXES, ETC.

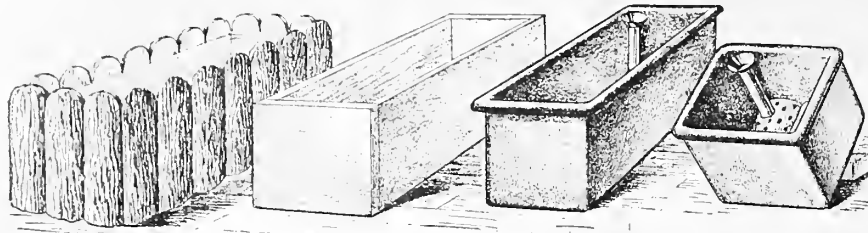

Rustic Window Box Plain Window Box Savo Window Box Savo Plant Tub

WINDOW BOXES

Plain Wood Style (Painted Green). We recommend these for use at the temporary summer home in the country or at the seashore, or in cases where one may not feel like spending a larger cost than these entail. They are substantially made and finished and will last many years.

Length	Depth outside	Width outside	Price
24-inch	6½-inch	8-inch	\$1.75
30-inch	6½-inch	8-inch	2.00
36-inch	6½-inch	8-inch	2.50

Any length made to order, 90c. per running foot, 8 inches wide.

WINDOW BOXES

Wooden Rustic Bark Style. Attractively made and neatly finished; for indoor or outdoor use.

Length	Depth outside	Width outside	Price
24-inch	7½-inch	11-inch	\$2.25
30-inch	7½-inch	11-inch	2.75
36-inch	7½-inch	11-inch	3.25

Any length made to order, \$1.25 per running foot 11 inches wide.

RUSTIC BARK (Cedar)

For covering boxes, columns or any other article. Per sq. ft., 10c.; \$2.25 per 25 sq. ft.; 50 sq. ft., \$4.00. Per bundle of 150 sq. ft., \$7.50.

WINDOW BOXES

Savo Self-Watering

The Savo Flower and Plant Boxes are made of the best grade of galvanized steel, with neat round corners and a full roll rim, the watering is easy, the drainage ample, the air circulation perfect. The green enamel finish both inside and out prevents rust or leakage. They will last in constant use many years. Reservoir requires water about every 10 days to two weeks.

Model	Height	Width	Length	Price
Model A,	6½ in.	6½ in.	23 in.	\$3.00
Model B,	8 in.	9½ in.	29 in.	4.00
Model C,	8 in.	9½ in.	35 in.	4.50
Model D,	8 in.	9½ in.	41 in.	5.00
Model E,	8 in.	12 in.	12 in.	3.00
Model F,	12 in.	12 in.	12 in.	3.50

These are outside measurements, including the ¾-inch roll rim. Special sizes made to order when required.

THE SAVO

Self-Watering Plant Tub

Model E—12x12-in. x 8-in. deep	\$3.00
Model F—12x12-in. x 12-in. deep	3.50

ALL PORCH AND WINDOW BOXES ARE SUPPLIED WITH DRAINAGE HOLES

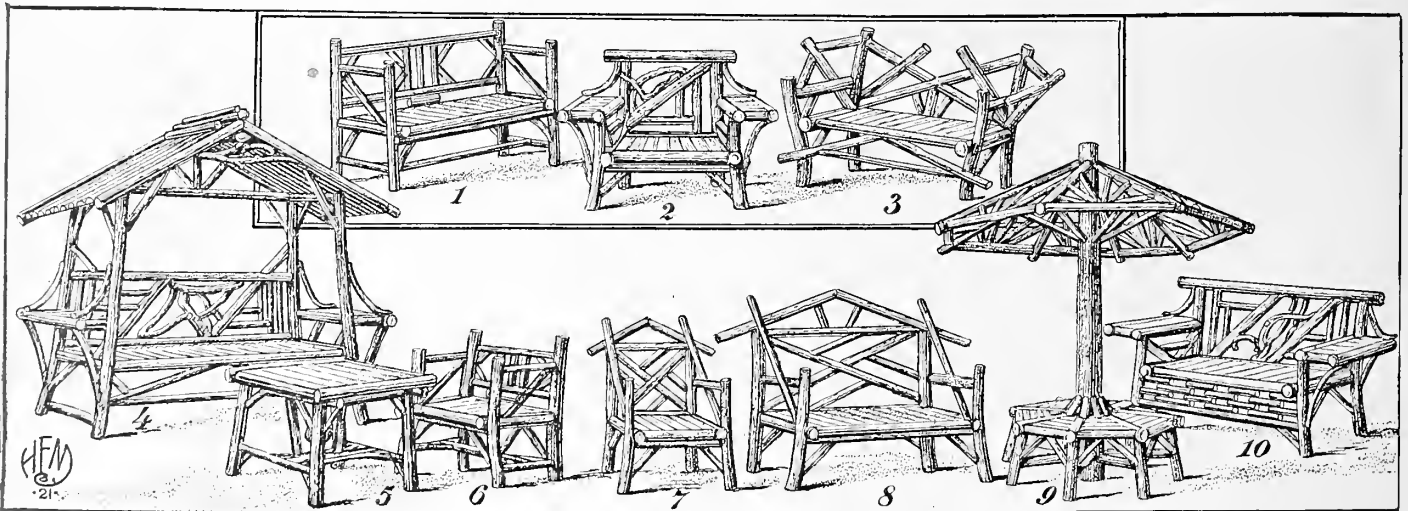

RUSTIC PORCH AND GARDEN FURNITURE

A rustic chair, settee, table or canopy add a charm to the surroundings of a country home, be it pretentious or modest. Our stock is in good assortment and priced very moderately. We are also in position to make special designs of rustic work, such as summer houses, bridges, etc. We will refer to these in description and price both by number and name so they may readily be identified.

- No. 1. **Mission Settee.** 4 ft. long, similar in design and construction to "Klondyke," except it does not have the extended arms. Price, \$10.00.
- No. 2. **Klondyke Chair.** Width 48 inches, including arms; very roomy and comfortable. Price, \$7.50.
- No. 3. **Florida Settee.** 4 ft. long; similar to "Elwood" style, except there is a difference in the design of the back. Price, \$4.50.
- No. 4. **Canopy Settee.** This is rather an extensive affair, weighing 250 lbs.; is shipped in two sections, but is easily set up; equipped with wide arms which can be used for plant boxes, etc.; will seat 4 persons comfortably. Extremely attractive and will add materially in beautifying the suburban home grounds. Price, \$36.00.
- No. 5. **Mission Table.** A table will be found a great convenience in a summer house, on a porch or under the shade of a tree; the top is 28 x 28 inches. Price, \$8.50.

- No. 6. **Mission Chair.** The construction of this is like the settee bearing the same name, except it seats one person. Price, \$7.00.
- No. 7. **Elwood Chair.** An attractively designed, reasonably priced piece of furniture. Price, \$3.00.
- No. 8. **Elwood Settee.** 4 ft. long; made with a high back and apex finish; extra good value for the money. Price, \$4.50.
- No. 9. **Japanese Umbrella.** Shipped in two sections, but easily erected; has a large seating capacity. The umbrella design top adds distinctively to its appearance. Can be supplied with a lattice or open top like illustration or with a slab top. Price, with slab roof, \$36.00; with lattice roof, \$44.00.
- No. 10. **Klondyke Settee.** 5½ ft. long; of attractive design, and made in the most substantial manner. Price, \$11.50.

IRON PLANT STANDS

These have a tilting device so that plant may be set at any angle if desired. Enameled green.

In.	Size of Plates	Each
12	5 x 7	\$1.40
18	5 x 7	1.50
24	8 x 10 1/2	2.25
30	8 x 10 1/2	2.35
36	8 x 10 1/2	2.50
42	8 x 10 1/2	2.60
48	8 x 12	2.75
60	8 x 12	3.00
72	8 x 12	3.25

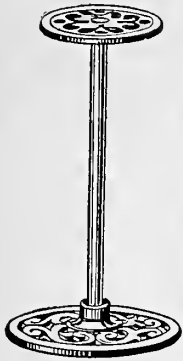

EXTRA PLATES FOR IRON STANDS

Each	Each
5 inch.....\$0.50	8 inch.....\$0.70
7 inch......60	10 1/2 inch......90
12 inch, each.....\$1.10	

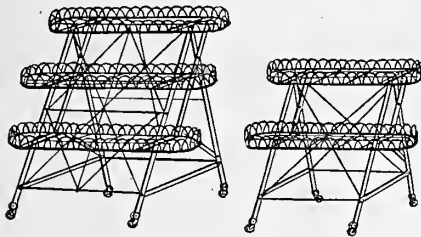

Jones Plant Stands

WIRE PLANT STANDS

Painted dark green and finished in bronze. Very substantial and will carry most any weight that can be placed on them. We recommend the Jones style, as it is collapsible and takes up very little space when not in use.

Jones, 2 shelf. \$5.00 | Jones, 3 shelf. \$6.00

When wire plant stands require packing for shipment by express and freight, there is a charge of 50c. made for packing.

JONES' POT BRACKET

No. 1. Holds 5-inch pot. Each, 55c.; \$6.00 per doz. Parcel Post Weight, each, 1 lb.

No. 2. Holds 6-inch pot. Each, 60c.; \$6.50 per doz. Parcel Post Weight, each, 2 lbs.

No. 3. Holds 7-inch pot. Each, 70c.; \$7.50 per doz. Parcel Post Weight, each 2 1/2 lbs.

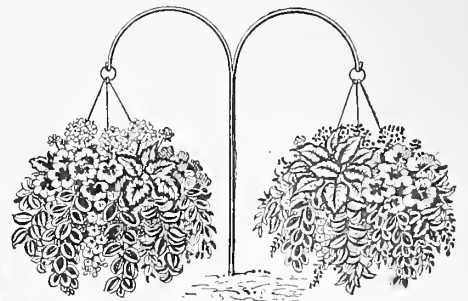

BASKET HOOKS

Thoroughly galvanized so they cannot rust. Single, 1 1/2-in. thick.....\$1.00 Double, 1 1/2-in. thick..... 1.50

These cannot be mailed.

HANGING BASKETS

Galvanized Wire

For greenhouse, porch and conservatory.

8 inch.....	\$0.30	\$3.00
10 inch.....	.40	4.00
12 inch.....	.60	6.00
14 inch.....	.70	7.25
16 inch.....	.85	9.00

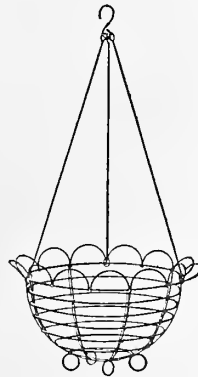

Wire Basket

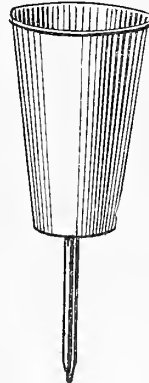

Tin Enameled Vase

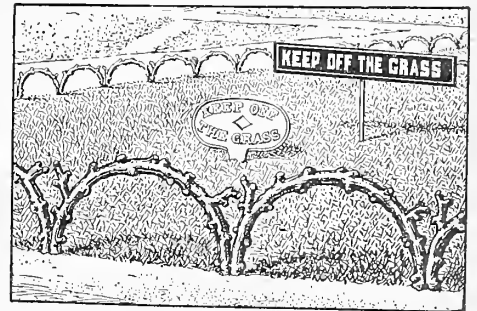

LAWN GUARDS

For path corners, flower beds, etc. Iron (see cut), nicely painted green, \$2.00 each; per doz., \$20.00. Not mailable.

Wire, made extra heavy and well galvanized. Price, 35c. each; per doz., \$3.50. Not mailable.

LAWN SIGNS

Excellent for putting on grass plots where thoroughfare is not desired.

Iron, painted gray, trimmed red, 75c. each; per doz., \$8.50. Parcel post weight, 4 lbs.

Enameled Iron Style. (See cut above). This pattern is best for conspicuous places. Name-plate finished with green and white enamel; 20 inches long and about 4 inches wide. Equipped with iron stake. \$2.25 each; per doz., \$25.00. Parcel Post Weight, 3 lbs.

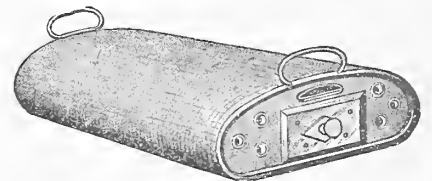

AUTOMOBILE HEATERS

These will keep the temperature above freezing in most any ordinary closed vehicle during the severest weather.

No. 2. Single drawer, 14-in. long. \$3.75 each.

No. 7B. 20-in., single drawer, covered with Brussels carpet. \$6.00 each.

No. 10. Three drawers. \$9.00 each.

Coal for automobile heaters. \$1.25 per doz. bricks; per 100, \$8.50.

Tongs for handling hot coal, 40c. pair.

VASES

For holding cut flowers on cemetery lots, etc.

IRON, PAINTED GREEN

No.	Wt.	Each
3 Large.....	4 lb.	\$0.75
2 Medium.....	2 lb.	.65

IRON, GALVANIZED

6 Large.....	4 lb.	\$0.85
5 Medium.....	2 lb.	.80

TIN, ENAMELED

Color, rich green; will not burst in cold weather.

No.	Wt.	Each	Doz.
2 Large.....	1/2 lb.	\$0.25	\$2.50

WALL NAILS

For fastening climbing vines; equipped with a soft metal clasp which holds the vine against the wall.

	Doz.	100
1 inch.....	\$0.45	\$2.75
1 1/2 inch.....	.60	3.75
2 inch.....	.75	4.50

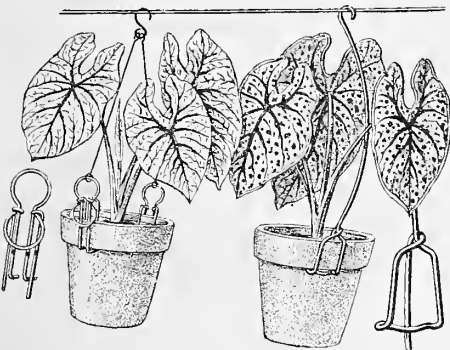

Krick's

Eureka

POT HANGERS

Wt. per Doz.	Each	Doz.
--------------	------	------

Krick's No. 1. For 3 to 5-in. pots.....1 lb. \$0.07 \$0.70

Krick's No. 2. For 6 and 7-in. pots.....1 lb. .08 .80

Krick's No. 3. For 8 to 10-in. pots.....1 lb. .09 .90

Eureka. Suitable for any size pot up to 8 inches. Made of galvanized wire, 15 inches long. 20c. each; \$2.00 per doz.; \$12.50 per 100.

Parcel Post Weight, each, 8 ozs.

HOT BED SASH

Philadelphia Style. Made of best quality cypress. Size, 3 feet 1½ inches wide, 6 feet long, 1¾ inches thick. Plain, not glazed or painted. Each, \$4.00.

Glazed, including painting and puttying. Each, \$10.00.

Sunlight Style. Plain, unglazed. Each, \$5.25. Glazed and painted. Each, \$12.00. Packing Charges on all Glazed Sash, 50c. per sash additional.

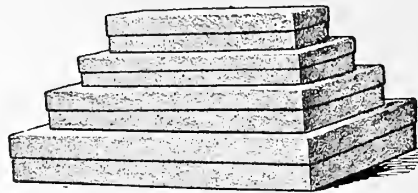
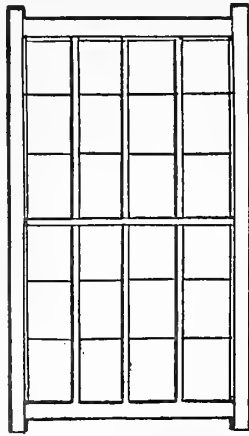

CUT FLOWER BOXES CORRUGATED PAPER

These are desirable for shipping cut flowers from country estates to city residences, very durable.

	Each	Doz.
48 x 14 x 8 inch	\$0.70	\$7.00
42 x 14 x 8 inch	.60	6.00
36 x 14 x 6 inch	.50	5.00
30 x 12 x 6 inch	.40	4.25
24 x 8 x 5 inch	.35	3.25

LIGHT WEIGHT PAPER

Mist green, lined white inside. The sizes offered in this finish are carried in stock, other sizes in this finish, also in manila, mist tan and oxford gray can be supplied on short notice.

L. W. D.	Doz.	100
18 x 5 x 3 inch	\$0.60	\$4.40
24 x 5 x 3½ inch	1.00	6.85
24 x 8 x 4 inch	1.15	8.50
28 x 8 x 5 inch	1.75	12.00
30 x 10 x 6 inch	2.10	16.00
30 x 12 x 7 inch	2.75	20.00
36 x 8 x 5 inch	2.00	15.00

We can also supply other sizes and styles of boxes.

PAPER FOR WRAPPING BOXES AND FLOWERS

	Lb.	½ Rm.	Rm.
Manila. For wrapping	\$0.20	\$2.25	\$4.00
Manila. Tissue	.25	1.15	2.00
Wax. White, 24 x 36 in.	.35	1.65	3.00
Wax. Green, 24 x 36 in.	.50	2.25	4.00

CREPE PAPER

Color, green. 50c. per roll.



ROOFING PAPER, ETC.

	Sq. ft.	Per roll
Celery Paper	500	Price on application
Marley Rubber Roofing, 1-ply	100	\$3.00
Marley Rubber Roofing, 2-ply	108	3.50
Marley Rubber Roofing, 3-ply	108	4.00
Caps for paper	1 lb., 12c.; 5 lbs., 55c.	
Nails for paper	1 lb., 12c.; 5 lbs., 55c.	

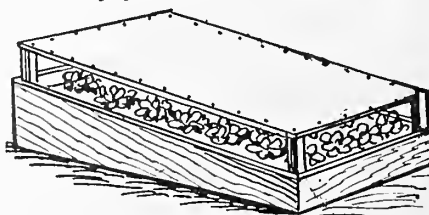

Shading or Protecting Cloth

For prices, see left hand column.

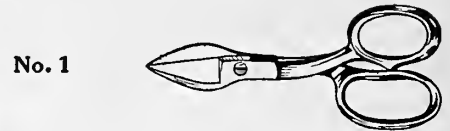

No. 1

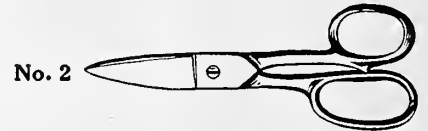

No. 2

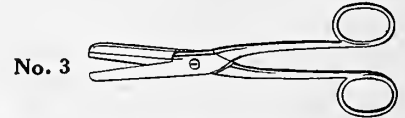

No. 3

Key to illustrations: No. 1, Wire and Tin Shears; No. 2, Grape Scissors; No. 3, Flower Scissors.

WIRE AND TIN SHEARS

No. 833. 7½ inch, used for cut flower wire, etc. \$1.30
No. 832. 8 inch, used for cut flower wire, etc. 1.30

Parcel Post Weight, 1 lb.
No. 12. 8-inch for heavy wire and tin 1.50
No. 10. 10-inch for heavy wire and tin 2.00
Parcel Post Weight, 2 lbs.

GRAPE SCISSORS

For thinning out bunches of grapes, and not disturbing the berries that are to remain for development.

No. 6148. 6 inch, P. P. Wt., 8 oz. \$2.25

FLOWER SCISSORS

No. 1922. Cuts flower and holds the stem. Price \$2.00
Parcel Post Weight, 4 oz.

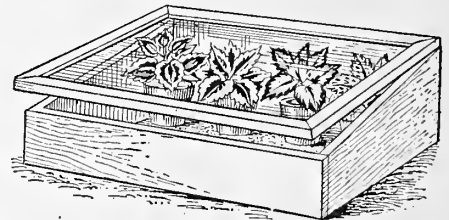

MINIATURE HOTBEDS

These are very handy to use in connection with window gardening. Suitable for raising seedlings or for rooting cuttings. Seeds started in these will mean an early flower or vegetable garden. 12 x 20 in., \$3.50 each. Complete with glass. Not available.

SUN DIALS

These ancient time-tellers are a part of every exclusive flower or vegetable garden, and indeed a very interesting one.

No. 350. 8-in. diam., bronze, plain, \$5.00 each.
No. 351. 9½-in. diam., bronze, with motto, \$6.00 each.
No. 105. 10-in. diam., bronze, with motto, \$6.50 each.
No. 107. 11-in. diam., bronze, with motto, \$9.50 each.

Prices do not include pedestal.



HOTBED MATS

Hotbed mats keep frost and severe cold out of frames. They mean earlier and bigger crops. The Burlap style are the best mats that it is possible to procure. They are padded with shoddy and are practically indestructible.

Burlap, Non-Waterproof. 76 x 76 inches, covering two regular size sash. Each, \$3.50; \$37.50 per doz.

Burlap, Non-Waterproof. 40 x 76 inches, for one sash. Each, \$2.25; \$25.00 per doz.

Burlap one side, Waterproof Drill one side. 76 x 76 inches. \$4.25 each; doz., \$45.00.

Burlap one side, Waterproof Drill one side, 40 x 76 inches. \$2.75 each; doz., \$30.00.

Each
Straw Mats. 3 x 6 feet \$2.00
Straw Mats. 6 x 6 feet \$3.50

Special size Hotbed Mats to order; any length, but only in 72-inch widths. Straw Mats made to order any length, 6 ft. wide. Under 100 sq. ft., 15c. per sq. ft.; 100 to 150 sq. ft., 13½c. per sq. ft.; 150 sq. ft., and over, at 12½c. per sq. ft.

SHADING OR PROTECTING CLOTH

Largely used as a substitute for glass where protection is desired. It is admirable for summer use, protecting plants, etc., from the sun and at the same time allowing ventilation. Made of brown cloth.

	Yards Per Piece	Price Per Yard	Price Per Piece
Light	60	\$0.15½	\$8.40
Medium	60	.22	12.00
Heavy	40	.30	10.80

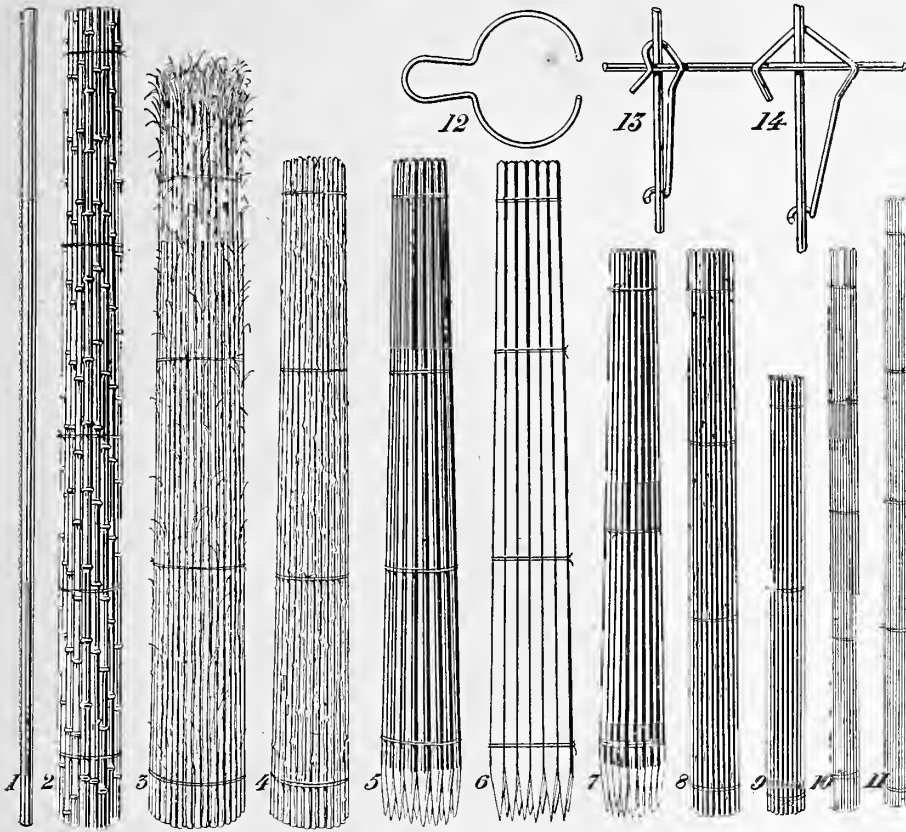

KEY TO ABOVE ILLUSTRATION: No. 1, Pole for Pruners; No. 2, Bamboo Poles, STAKES; No. 3, Southern Cane; No. 4, Japanese Cane, Natural; No. 5, Dahlia, No. 6, Square; No. 7, Tapering; No. 8, Japanese Cane, green; No. 9, Hyacinth; No. 10, Galvanized Wire, No. 10, wire; No. 11, Galvanized Wire, No. 8, wire; No. 12, Wire Plant Tie; No. 13, Eureka Stake Fastener; No. 14, Everlasting Stake Fastener.

CANE STAKES

Southern	Doz.	100	250	1000
6 to 7 feet	\$0.35	\$2.00	\$3.75 \$12.50

JAPANESE GREEN CANE STAKES
These are very attractive for all purposes of plant staking; thin and very strong.

	Doz.	100	500	1000
1½ feet	\$0.15	\$0.75	\$3.25 \$ 6.00
2 feet20	1.25	5.50 9.00
2½ feet25	1.40	6.75 11.00
3 feet35	1.60	7.00 12.50
3½ feet35	2.00	8.00 14.00
4 feet40	2.25	9.00 15.00
5 feet50	2.50	10.00 16.00

JAPANESE NATURAL CANE

STAKES

	Doz.	100	500	1000
2 feet	\$0.15	\$0.90	\$4.50 \$ 8.00
2½ feet20	1.35	5.75 9.00
3 feet25	1.60	7.00 11.00
4 feet30	2.00	7.50 12.00
6 feet40	2.25	10.00 15.00

WIRE STAKE TIE (Buschardt's)

For fastening plants to stakes, either wire or wood; can be used many times. 1000 ties in a pkg. Price, \$2.50.

STAKE FASTENERS

These take the place of string entirely, lasting several seasons; used for fastening cross wires to galvanized stakes.

	P.P.Wt. per 100	500	1000
Everlasting Style ½ lb.	\$2.25	\$4.00
Eureka Style ¼ lb.	1.40	2.75

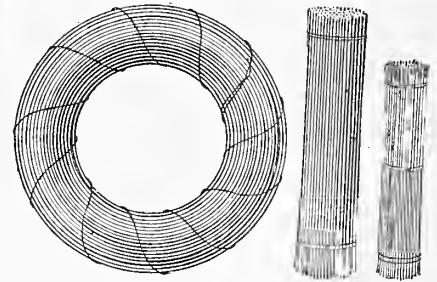

WIRE

Allow for postage if wanted by mail.

No. 16.	Galvanized	\$0.20	12-lb. Lb. Stone
No. 18.	Galvanized22	1.75
No. 19.	Galvanized24	2.00
No. 20.	Galvanized26	2.10
No. 22.	Galvanized28	2.25
No. 16.	Annealed18	1.30
No. 18.	Annealed20	1.50
No. 20.	Annealed24	1.65
No. 22.	Annealed26	1.85
No. 24.	Annealed28	2.00

TINNED WIRE

Used for bunching celery, etc. No. 19, in 10-lb. boxes, cut 8½ inches, 30c. per lb.; per box, \$2.50.

CUT BOUQUET WIRE

For Stemming Flowers

Cut 9, 12 or 18 inches in length.	
No. 20, 25c. per lb.; per box, 12 lbs. \$2.00
No. 22, 30c. per lb.; per box, 12 lbs. 2.25
No. 24, 35c. per lb.; per box, 12 lbs. 2.75

BAMBOO POLES

Used extensively for brushing worm casts off Putting Greens, also for staking young trees.

	Each	Doz.	100
15½ to 16 feet long	\$0.50	\$5.50 \$40.00
17½ to 18 feet long60	6.50 50.00
19 to 20 feet long75	7.50 60.00

Poles for Tree Pruners

12 feet long, 1¼ inch diam.	\$2.00
14 feet long, 1½ inch diam.	2.25

HYACINTH STAKES

Used for staking hyacinths, tulips and slender plants; dyed green.

	P.P.Wt. per 100	Doz.	100	1000
5 inch 1½ lbs.	\$0.05	\$0.25	\$1.50
12 inch 2 lbs.	.07	.35	2.50
18 inch 2 lbs.	.10	.45	3.50

GALVANIZED WIRE STAKES

No. 10 WIRE, LIGHT

	P.P.Wt. Doz.	Doz.	100	1000
2 feet 1½ lbs.	\$0.25	\$1.10	\$8.50
2½ feet 1½ lbs.	.30	1.50	11.00
3 feet 2 lbs.	.35	1.75	12.50
3½ feet 2¼ lbs.	.40	2.00	15.00
4 feet 2½ lbs.	.45	2.10	17.00
4½ feet 3 lbs.	.50	2.25	19.00
5 feet55	2.35	21.00
5½ feet60	2.50	22.50
6 feet70	2.85	25.00

No. 8 WIRE, HEAVY

	P.P.Wt. Doz.	Doz.	100	1000
2 feet 2 lbs.	\$0.35	\$1.60	\$12.50
2½ feet 2½ lbs.	.40	1.75	16.00
3 feet 3¼ lbs.	.45	2.00	17.50
3½ feet 3 lbs.	.50	2.50	21.00
4 feet 3½ lbs.	.55	2.75	23.00
4½ feet 4 lbs.	.60	3.00	26.50
5 feet65	3.25	28.00
5½ feet70	4.00	32.00
6 feet75	4.25	34.00

TAPERING PLANT STAKES

PAINTED GREEN

	Weight per Doz.	Each	Doz.	100
1½ feet ½ lb.	\$0.03	\$0.30	\$2.00
2 feet ½ lb.	.05	.50	3.75
2½ feet 1 lb.	.07	.75	5.50
3 feet 1¼ lbs.	.10	1.00	7.00
3½ feet 1½ lbs.	.11	1.10	8.50
4 feet 2 lbs.	.13	1.40	11.00
5 feet16	1.85	13.50

ROSE OR DAHLIA STAKES

Round tapering style; painted green.

	Weight per Doz.	Each	Doz.	100
3 feet 2½ lbs.	\$0.13	\$1.44	\$11.00
3½ feet 4 lbs.	.15	1.66	13.00
4 feet 5 lbs.	.17	1.92	15.00
5 feet22	2.50	19.00
6 feet27	3.10	23.00

SQUARE PLANT STAKES

These are painted green and nicely tapered and finished.

	Weight per Doz.	Each	Doz.	100
1½ feet ½ lb.	\$0.03	\$0.30	\$2.00
2 feet ½ lb.	.05	.50	3.00
2½ feet 1 lb.	.06	.60	4.25
3 feet 2 lbs.	.11	1.08	7.50
3½ feet 2½ lbs.	.12	1.15	8.50
4 feet 4 lbs.	.15	1.40	9.75
5 feet20	2.00	14.00
6 feet25	2.50	16.50

MICHELL'S HORTICULTURAL AND GARDEN SUPPLIES

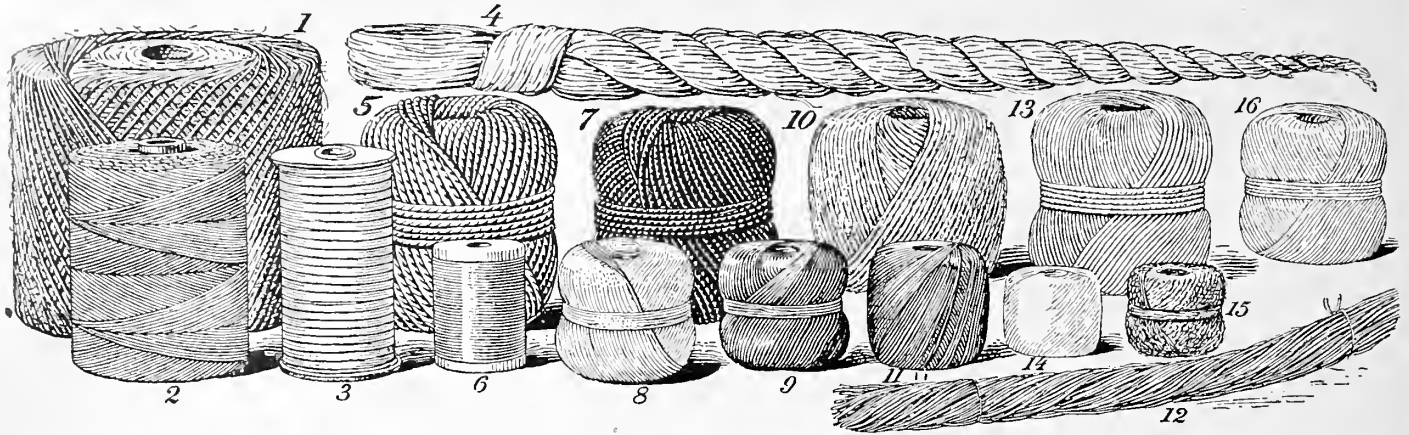

Key to above illustrations. No. 1, Binder; No. 2, Peerless; No. 3, Raffiatape; No. 4, Raffia; No. 5, Express; No. 6, Silkaline; No. 7, Tarred Martin; No. 8, Cayuga, Medium; No. 9, Smilar; No. 10, Jute; No. 11, Green Sea Island; No. 12, Tarred Sisal; No. 13, Japanese; No. 14, Special White Cotton; No. 15, Linen Bouquet; No. 16, Cayuga, heavy.

TWINES, ETC.

	Ball	Lb.
No. 108. White Cayuga, Medium	\$0.35	\$0.65
No. 208. White Cayuga, Heavy	.35	.65
Jute, 2-ply and 3-ply	.20	.35
Linen Bouquet	.15	1.00
Green Sea Island	.15	.90
No. 4½. Japanese Twine, Medium heavy	.20	
Jefferson White Cotton, 3-ply	.13	.60
Peerless. Color, Nile green		1.00
Tarred. For mat making	.40	
Tarred Sisal. For fodder		.15
Binder		.20
Express. Very heavy	.30	
Green Silkaline. For stringing Smilax and Asparagus, etc. F, fine; FF, medium; FFF, coarse.		
Price, per spool, 40c.		
Price, per lb. (3 spools)		\$2.75
Smilax Twine (Silkaline Substitute). Very similar to the above; fast color. Price, 25c. per spool; per lb., \$1.50.		

RAFFIA

For tying, basket making and fancy work; very long and fibrous. Natural Color, 25c. per lb.; 5 lbs., \$1.20. Green, \$1.00 per lb.; 5 lbs., \$4.75.

RAFFIATAPE

This article is made of a composition of paper and linen and is tremendously strong; it is about 1/8 inch wide and is put up in 250-yard bolts or hanks. This is very desirable for tying bouquets, flower boxes or for any other purpose where attractive tying material is desired. Color, Nile green. Parcel Post Weight, per bolt, 1/2 lb. Per bolt of 250 yards, 90c.



Permanent Metal Label

Permanent Metal Label. See prices opposite column.



TREE LABELS

	Parcel Post Weight, 1/2 lb. per 100.	100	1000
Iron Wired. Plain	\$0.30	\$2.00	
Iron Wired. Painted	.40	2.50	
Copper Wired. Plain	.40	2.50	
Copper Wired. Painted	.50	3.00	
Copper Sheet, wired 30c. doz.; 1.75			
Zinc Sheet, wired 30c. doz.; 1.75			
Indelible Marking Pencils. Each		.18	

PAINTED POT LABELS

	P. P. Wt. per 100	100	1000
4 inch	1/2 lb.	\$0.30	\$2.00
4½ inch	1/2 lb.	.35	2.50
5 inch	1/2 lb.	.40	2.75
6 inch	3/4 lb.	.50	3.25
8 inch	2 lbs.	1.50	8.75
10 inch	2½ lbs.	1.90	11.50
12 inch	3 lbs.	2.25	13.65
18 inch, for field use	7 lbs.	6.00	55.00

PERMANENT METAL LABEL

For marking all plants, trees, etc., in a manner to last forever. Every rare and beautiful variety in your garden deserves a permanent label. Part of the pleasure in wandering thru a garden is to know accurately the name of the plant or flower that attracts your attention. Imagine, if you will, how neat and lasting would be your plant record if every plant had attached to it a label as illustrated, made of zinc. In furnishing labels, we undertake to put name of variety only on same—not species. For instance in the case of Rose La France, we would furnish label embossed "La France". They are always legible, time and weather have absolutely no harmful effect. In ordering allow one week for the execution of order. Write your list plainly, preferably on a typewriter. Not less than 25 labels can be supplied.

Price 5c. per label, copper wired ready to attach to plant, bush or tree. One or as many of a variety as may be desired can be supplied. The price is 5c. irrespective of the quantity wanted over the minimum of 25. See illustration opposite column.

SUNDRIES

- Bulb Fibre.** Qt., 20c.; 45c. per 1/2 pk.; pk., 75c.; \$1.25 per 1/2 bu.; bu., \$2.00.
- Bull Dog Clips.** For fastening packages, etc., \$1.00 per box.
- Carnation Bands (Rubber).** For mending bursted calyx. 30c. per oz.; 1/4 lb., \$1.00.
- Carnation Clips (Bawrs).** For mending carnations. \$1.00 per 1000.
- Carnation Staples (Wire).** 50c. per 1000.
- Celery Tape.** Fast red, in 1000-yard spools, \$4.50.
- Charcoal (Lump).** For use in potting. Pk., 65c.; \$2.25 per bu.; bbl. sack, \$3.25.
- Charcoal (Ground).** Coarse, fine and powdered. Per lb., 8c.; 35c. per 5 lbs.; 10 lbs., 60c.; \$1.25 per 25 lbs.; 100 lbs., \$4.00.
- Glass Cleaner.** \$2.75 gal.; 5 gals., \$11.00.
- Grafting Wax.** 1/4 lb., 15c.; 25c. per 1/2 lb.; lb., 45c.
- Moss (Green Lump).** Pk., 60c.; \$1.50 per bu.; bbl. bag, \$3.00.
- Moss (Green Sheet).** 1/2 pk., 40c.; 70c. per pk.; bu., \$2.00; \$3.50 per sack.
- Moss (Sphagnum, dry).** Bbl. bags, \$1.50; \$4.00 per large bale.
- Moss (Sphagnum, live).** Pk., 50c.; \$1.50 per bu.; bbl., \$3.25.
- Peat or Leaf Mould.** Pk., 50c.; \$1.50 per bu.; bbl., \$3.25.
- Peat (Orchid.)** Pk., 75c.; \$1.75 per bu.; bbl. bag, \$3.25.
- Pebbles.** Qt., 10c.; 75c. per pk.; bu., \$2.00; \$4.00 per bbl.
- Pruning Compound.** Per qt., 85c.; \$2.50 per gal.
- Sand.** For propagating. Per qt., 10c.; 40c. per pk.; bu., \$1.40; \$3.00 per bbl.
- Shaderine.** For shading greenhouse glass. 5 lbs., \$1.50; \$3.00 per 10 lb. can.
- Soil.** For potting. Qt., 10c.; 25c. per 1/2 pk.; pk., 40c.; \$1.50 per bu.; bbl., \$3.25.
- Tin Foil (Plain).** In 5 and 6-inch widths. 1-lb. pkgs., 25c.; 5 lbs. for \$1.20; 5-inch width in 5-lb. rolls, \$1.20. Green or violet in 1-lb. pkgs., 60c. per lb.
- Toothpicks.** Wired. 50c. per 1000; 10,000, \$3.75.
- Toothpicks.** 4-inch, wired, green; per 1000, \$1.00; \$3.75 per 4500.
- Toothpicks.** 6-inch, wired, green; per 1000, \$1.20; \$3.30 per 3000.
- Tree Paint (Target Brand).** Qt., 85c.; \$2.50 per gal.
- Weed Killer.** Qt., 55c.; 90c. per 1/2 gal.; gal., \$1.75; \$6.75 per 5 gals.; 30 gals. \$33.00; \$50.00 for 50 gals.
- Zementine.** For whitewashing and shading. 2 lbs., 40c.

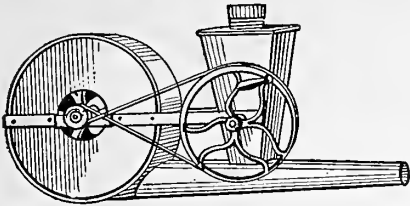

SULPHUR BLOWER

For distributing sulphur and insecticides of various kinds. Made of heavy metal with no wearout to them. A man can dust a very large house in a few minutes, using one of these blowers. Price, \$8.00.

VAPORIZING LAMP

Practical and indestructible; all metal; burns kerosene; used for dispensing fumes of Nikoteen and other preparations of this sort. 85c. each.

Parcel Post Weight, 3/4 lb.



Vaporizing Lamp

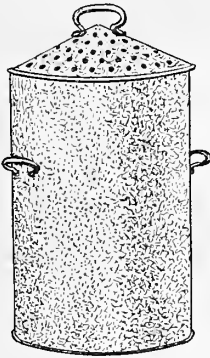

Perfection Fumigator

FUMIGATORS

Perfection Make

Fitted with a water tank to prevent burning out.

- No. 1 for house 12 x 40 ft. \$6.25
- No. 2 for house 14 x 100 ft. 7.75
- No. 3 for house 20 x 100 ft. 9.50
- No. 5 for house 20 x 150 ft. 11.50

Eureka Make

- No. 1 for house 10 x 20 ft. \$3.50
- No. 2 for house 12 x 40 ft. 4.00
- No. 3 for house 15 x 100 ft. 5.50
- No. 4 for house 20 x 100 ft. 7.50

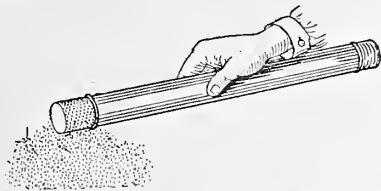

DICKEY DUSTER

Excellent for distributing Bug Death, Slug Shot, etc. Price, 50c. P. P. weight, 1 lb.

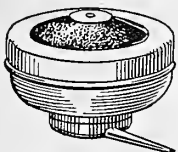

WHIRLWIND POWDER GUN

For distributing dry powder. Price, 35c. P. P. Weight, 8 oz.

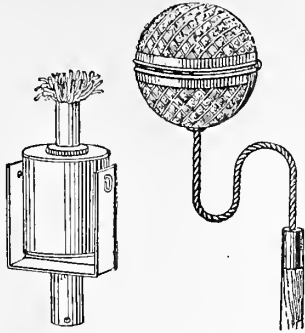

Reservoir Torch Asbestos Torch

OIL TORCHES

For burning out worms, caterpillars and other tree pest.

- | | | |
|-----------|--------------|--------|
| | P.P.Wt. Each | |
| Reservoir | 1/2 lb. | \$0.60 |
| Asbestos | 1 lb. | .65 |

POLES FOR TORCHES, Etc.

Hardwood, 12 feet, \$2.25; 14 feet, heavy, \$2.50. Poles are not mailable.

WOODASON HAND BELLOWS

- | | | |
|--------------------------|---------|--------|
| | P.P.Wt. | |
| No. 3. Large double cone | 5 lbs. | \$6.75 |
| Large single cone | 3 lbs. | 4.75 |
| No. 1. Small single cone | 2 lbs. | 3.25 |
| No. 2. Sulphur bellows | 3 lbs. | 4.00 |

No. 1

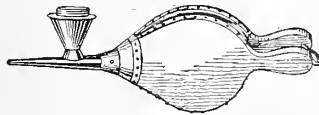

No. 2

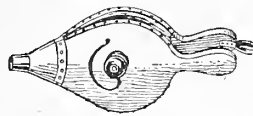

No. 3

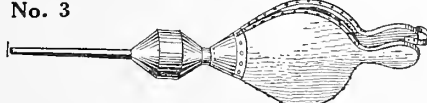

PARIS GREEN SHAKERS

Tin. For dusting vegetables, potatoes, small fruits and shrubbery, 65c. each. P. P. Weight, 2 lbs.

Farmers' Favorite. (See cut.) Large double action affair, \$3.75 each. P. P. weight, 4 lbs.

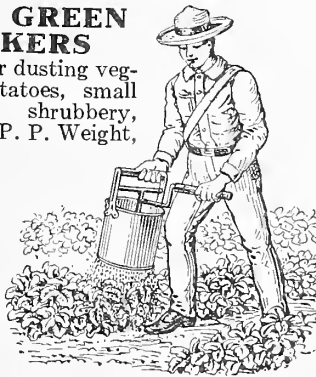

B. D. SHAKER

For applying dry insecticides, such as Bug Death, Slug Shot, Paris Green, etc.; made of tin; practical and durable. P. P. Weight, 3 lbs., 85c.



THE EASY WAY

JUST SLIP THE SEALED CARTRIDGE IN THE GUN THAT'S ALL!

No Handling. No Mixing. No Weighing. No Measuring of Poisons. Makes Successful Gardening a Pleasure.

Compare the ordinary method of mixing wet sprays or filling loose dust devices with the new patented up-to-date improved Key Duster Simplicity and Cartridge Convenience. No longer need you neglect your garden, flowers or fruit because of such troublesome old-fashioned practice.

More Vegetables. Better Fruit. Beautiful Flowers and Shrubs.

By using specially prepared materials, approved by the Agricultural Experimental Stations, all in Handy Sealed Cartridges ready to apply instantly without waste.

All Handy Sealed Cartridges, 15c each.

For Vegetable and Small Fruit,	B. A. Cartridge.
For Flowers and Shrubs,	Ofloro Cartridge.
For Fruit & Vegetables Nearly Ripe,	Hellebore Cartridge.
For Aphid and Many Soft-Bodied Insects,	Kaphore Cartridge.
For Orchard Fruit,	L. A. S. Cartridge.

Key Duster Gun \$1.50

A complete Garden Spray Calendar is supplied with every Gun.

FOR FLOWERS, FRUITS, VEGETABLES AND GARDENS

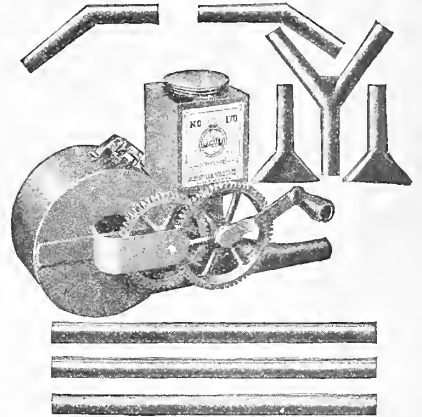

UTILITY DUSTER

Used for the application, in dry form, of Arsenate of Lead, Paris Green, etc. Made of heavy tin, enameled red; iron and brass machined cut gears. Provided with tubes, connections and nozzles as illustrated; also an adjustable carrying strap. Price, \$13.00.

ERADO WEED GUN

(See Cut)

As handy as a cane, which it resembles. Fill the reservoir, which holds about 2 quarts of liquid, with some weed-destroying preparation, diluted and used for destroying weeds of all kinds in lawns without hurting the grass. Press the sharp point of the gun into the heart of the weed until the flat stay pieces touch the ground, when a quantity sufficient to kill is discharged into the heart of the plant which is destroyed for all time. (Galvanized iron.) Price, \$1.25. Parcel Post Weight, 2 lbs.



MICHELL'S SPRAYING APPARATUS

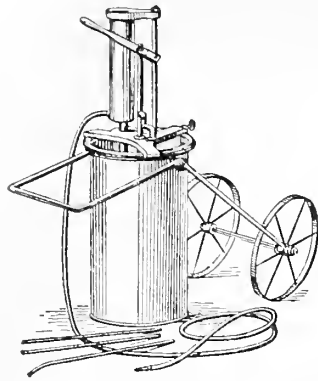

No. 3 Paragon Sprayer

THE PARAGON SPRAYER

Especially desirable for the reason that it is not necessary to strain the material before pouring it into the reservoir, although we recommend that this be done; guaranteed to give absolute satisfaction. Excellent for applying whitewash or paint.

- No. 0. Capacity, 3 gallons; equipped with 4 ft. of hose, one 3-ft. extension pipe and 2 spray nozzles. Price, \$12.50.
- No. 1. With a 5-gal. reservoir, 5 ft. of hose and 2 extension pipes, \$17.50; complete with truck, \$22.50.
- No. 3. Equipped with a 12-gal. tank mounted on a truck, three 2½ ft. extension pipes, 2 nozzles and 10 ft. of hose, \$25.00. Without truck, \$21.50. We can also supply this sprayer with single wheel at same price.

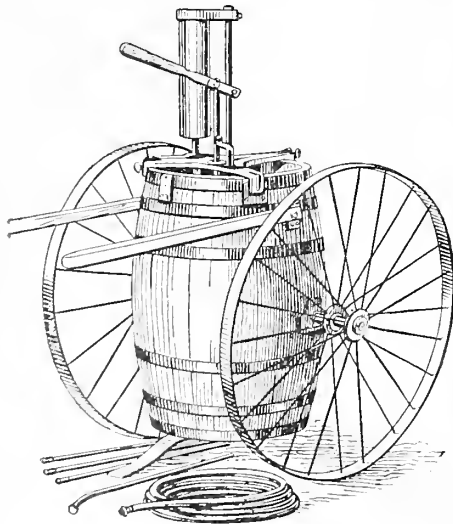

No. 4 Paragon Sprayer

- No. 4. Mounted on a two-wheel truck; equipped with 10 ft. of extension pipe, 20 ft. of hose and 2 nozzles. 25-gal. barrel, complete, \$39.50. Without truck, \$29.50.
- No. 5. Capacity of barrel 50 gallons, equipped with 25 ft. 6-ply hose, 1 10-ft. iron extension pipe, 1 3-way nozzle and 1 single spray nozzle, no truck, \$45.00.

Bucket Washers for Paragon Sprayers, 30c.

Fittings for Paragon Sprayers

Fig.	Price	Fig.	Price
1. 2-way Spray	\$2.00	9. Strainer	\$0.75
2. 1-way Spray	1.00	12. Female Hose Coupling	.35
4. Extension Pipes, per ft.	.15	23. Stop-Cock	1.00
6. Y Fitting	1.00	11. Mist Spray Nozzle with S. and B.	.50
7. Hose Coupling	.50	23. Brass Hose Bands	each .10

We can also supply other fittings for above Sprayers.

GOULD'S FRUITALL BARREL PUMP No. 1188

A high-grade pump at an attractive price, within the reach of every one who has need for such a pump. 2 in. diameter cylinder. Bronze wearing parts. Plain pump, no hose, nozzle or barrel, \$12.00.

Outfit C.—With agitator, one 15 ft. lead of ½ in. spray hose and one Mistry Jr. nozzle (no barrel), \$18.00.

Outfit D.—With agitator, two 15 ft. leads of ½ in. spray hose and two Mistry Jr. nozzles (no barrel), \$24.50.

Barrels for holding spray solution, 50 gal. capacity, \$6.50.

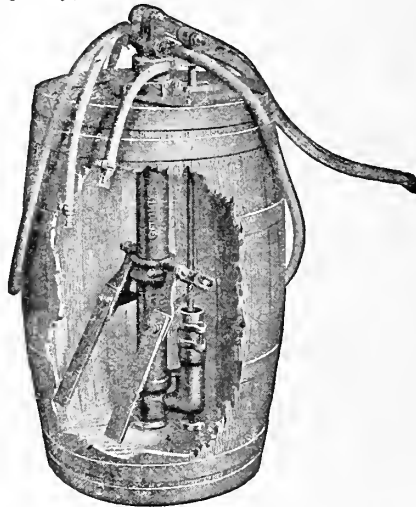

GOULD'S POMONA PUMP

Can be used for feeding one or two leads of hose; all working parts are bronze, with lasting qualities. **Pomona Fig. 1100.** Plain pump, 2½ in. diam. cylinder only, \$22.00.

Pomona Fig. 1100 Outfit C.—With one 15 ft. section ½ in. spray hose and one Mistry Jr. nozzle (no barrel), \$27.50.

Pomona Fig. 1100 Outfit D.—With two 15 ft. sections ½ in. spray hose and two Mistry Jr. nozzles, \$33.50.

Barrels for holding spray solution, 50 gal. capacity, \$6.50 each.

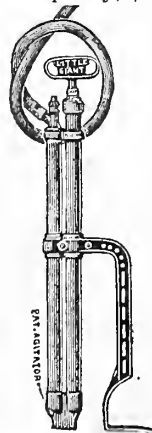

Myers Pump

No. 327½ MEYERS' BUCKET PUMP

This is a double brass chamber arrangement, and fills the want of those desiring a medium-priced sprayer. Price, \$6.00. P. P. Weight, 8 lbs.

A complete line of Insect Destroyers will be found on pages 188 and 189.

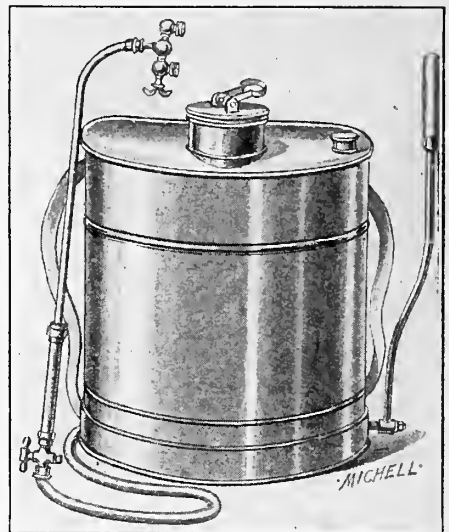

No. 1 MYSTO KNAPSACK SPRAYER

A new French knapsack sprayer which works on a compressed air principle. Compact in construction and light in weight, so that it can be easily carried around. We will sell this sprayer under the condition that if it is not the best purchase in this line you may return it at our expense and your account will be credited in full after you have given it a thorough trial. Price, \$25.00.

AUTO SPRAY

This operates by compressed air; safe and efficient; liquid capacity, four gallons; pressure capacity, 40 lbs. No sprayer is sold under broader guarantee for efficiency and durability. They will successfully spray bushes, shrubbery and trees, the latter with the use of extension pipes. The brass tank sprayer is the best as corrosive solutions can be used in it without injuring the same. Auto-Sprayers are not mailable.



No. 1-B.—**Brass**; equipped with hose and Auto-Pop Attachment, \$9.50.

No. 1-D.—**Galvanized Iron**; equipped with hose and Auto-Pop, \$6.50.

Auto-Pop Nozzle Attachment; controls the flow instantly by a pressure of the hand. When Auto-Pop Attachment is purchased separately: Plain, \$2.00 each. \$2.50 complete with hose. P. P. Weight, 1 lb.

BOOKS ON SPRAYING

Spraying Crops (Weed)	\$0.90
Spraying of Plants, The (Lodeman)	1.00



DEMING KNAPSACK SPRAYERS

These are elegant for carrying around the garden, among shrubbery and tree work, etc.

Fig. 675. Copper tank, holding about 5 gals., complete with pump, nozzle and hose... \$22.50

Fig. 654. Galvanized tank, holding about 5 gals., complete with pump, nozzle and hose... 16.50

Deming Knapsack Sprayers are not mailable.

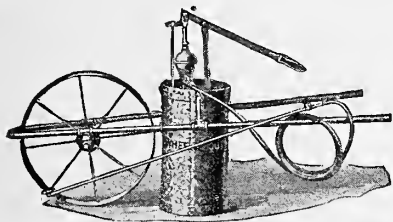

DEMING WHEELBARROW SPRAYER

A machine that is nicely balanced and easily transported. Extreme width 18 inches; narrow enough to go through the aisles of a greenhouse, 24 in. wheel with a 3 inch tread, making it easily handled over soft and rough ground. Pump has 1½ in. diam. cylinder, with adjustable stroke. Equipped with 12-gal. galvanized tank, 10 ft. hose, 4 ft. extension pole, nozzle and shut off valve. Price, \$27.50.

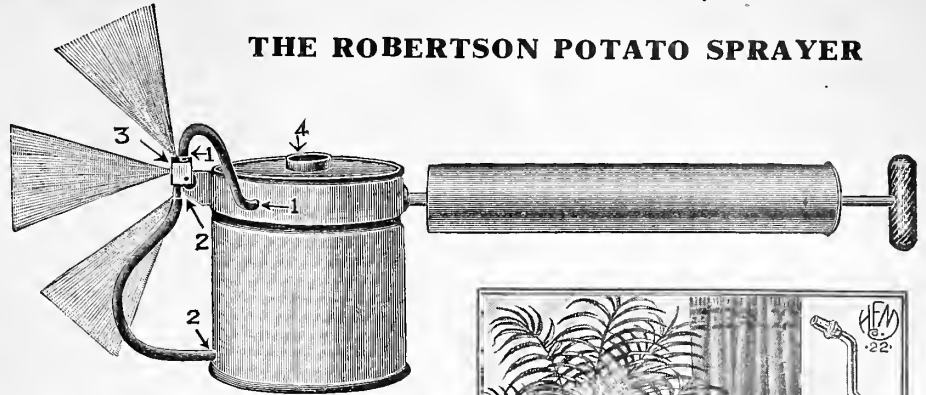

THE ROBERTSON POTATO SPRAYER

This is probably the first successful hand sprayer that distributes in a systematic fashion a spray solution on the top and underneath the foliage of potato vines and other plants. It is made of galvanized iron, in a substantial manner, and the reservoir is of liberal size; it may be used for general spraying in the vegetable and flower garden as well as elsewhere. Price, \$1.75.

BUCKET SPRAY PUMP

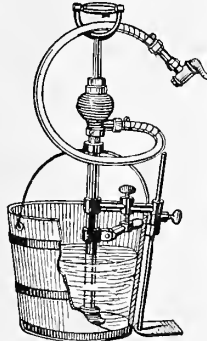

These are made entirely of brass, except the foot rest and hand grip. The prices below do not include bucket, but include nozzle and 3½ feet of 3/8-in. hose and nozzle.

No. 256. **Success** (without bucket fastener), \$7.75. P. P. Wt., 7 lbs.

No. 689. **Perfect Success** (with bucket fastener), \$8.25. P. P. Wt., 9 lbs.

JIM DANDY HAND SPRAYER

Adapted for spraying vegetables and flowers, small fruits, etc.; also valuable for spraying disinfectants in buildings. Heavy seamless brass pump; brass nozzle, non-cloggable; throws long distance fine mist or coarse spray. Price, \$3.50.



Misto Sprayer

THE MISTO SPRAYER

An ideal sprayer for applying various insecticides to house plants. Makes a fine mist, avoiding all drip; so simple in design it will last forever; nothing to get out of order; made of metal, nicely nicked; can be used in connection with most any ordinary bottle. Guaranteed in every respect or money back. Price, without bottle, \$1.25.

COPPER STRAINER

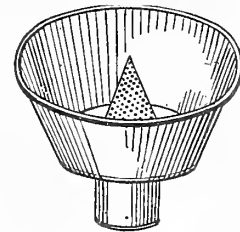

For straining white-wash, spraying material, etc. The neck is of the correct size to fit into the reservoir of an auto-spray, which allows both hands to be free when using it. \$1.40 each.

P. P. Weight, 1 lb.



AUTOMATIC COMPRESSED AIR SPRAYER

Parcel Post Weight, 2 lbs.

This is the grandest hand sprayer ever offered, very easily operated, especially desirable for ladies' use.

Tin. Each...\$1.00 | Brass. Each...\$2.00



HEAVY BRASS SYRINGES

Parcel Post

No.	Diam.	Length	Wt.	Price
99.	1½ in.	18 in.	1 spray... 1¾ lbs.	\$4.75
101.	1¼ in.	14 in.	2 sprays... 2 lbs.	5.00
101A.	1½ in.	16 in.	2 sprays... 2¼ lbs.	5.50
110.	1¾ in.	20 in.	2 sprays... 4½ lbs.	11.00
120.	1¾ in.	20 in.	Adjustable 5 lbs.	13.00

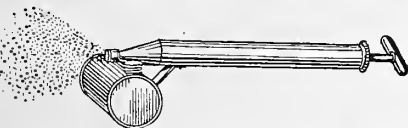

CYCLONE HAND SPRAYER

Similar to the above, except they do not have the automatic air reservoir attachment. P. P. Weight, 1½ lbs.

No. 112, Tin, large, 50c. No. 114, Brass, \$1.00.



EXTENSION PIPES, ETC.

For reaching into trees; 3/8 inch threads. **Bamboo**, aluminum tube; 10 feet... \$4.50
Galv. Iron, 2 ft., P. P. Weight, 6 ozs... .50
Brass, 2 ft., P. P. Weight, 8 ozs... .65
Pet Cock, for extension pipes... 1.25
Paragon Extensions, 2½ ft., 55c. each.
 Parcel Post Weight, 12 ozs.

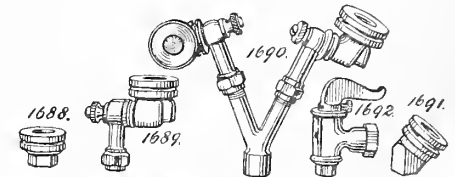

SPRAY NOZZLES (3/8-in. Thread)

Mistry, Jr., Fig. 1688, Straight style... \$0.85
 Mistry, Jr., Fig. 1691, Elbow style... .85
 Mistry, Fig. 1689, Single nozzle, adjustable angle... 1.60

Mistry, Fig. 1690, Double nozzle, adjustable angle... 3.50

Bordeaux Nozzle, Fig. 1692, P. P. Weight, 8 oz., each, \$1.35.

If nozzles are wanted for ¼-in. hose connections, add 65c. to above prices for Fig. 966 combination.

MICHELL'S RELIABLE POULTRY SUPPLIES

THE APACO AUTOMATIC FEEDER

The Apaco Feeder, in general design, is built on the same lines as the well-known and justly famous Norwich Automatic Exerciser and Feeder, but is a hanging machine rather than arranged with adjustable standard.

Constructed of 28-gauge galvanized, tight coated sheeting, malleable and gray iron castings for the valves, agitators, collars, etc., and the workmanship of the highest possible character, we unhesitatingly guarantee the APACO FEEDER as the best machine ever placed on the market at its price.

12-qt. capacity, \$2.00 each.
Parcel post weight, 7 lbs.

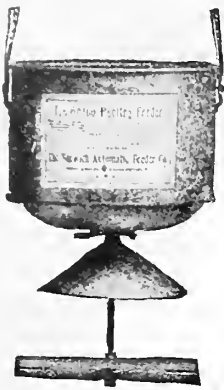

Norwich Automatic Poultry Feeder

In operating the Norwich Automatic Exerciser and Feeder, it is but necessary to fill the hopper with such grain as may be desired, straight or mixed, filling the feed bar with either cracked corn or wheat, and adjust the valve at the bottom of the hopper to feed in such quantities as desired. Set the machine anywhere in the yard, pen or house, give the feed bar a turn or two and, surprising as it may seem, in ten to fifteen minutes every hen in the flock will take in the situation and work it.

Another valuable feature is the fact that the hopper, being rain-proof, the feed is always dry and fresh. The hopper is also dust-proof, and not a particle of dust can get on the feed.

No. 1—8-quart hopper. Weight, 15 lbs., \$5.00.

No. 2—14-quart hopper. Weight, 18 lbs., \$5.50.

No. 3—20-quart hopper. Weight, 22 lbs., \$6.50.

No. 4—32-quart hopper. Weight, 25 lbs., \$7.50.

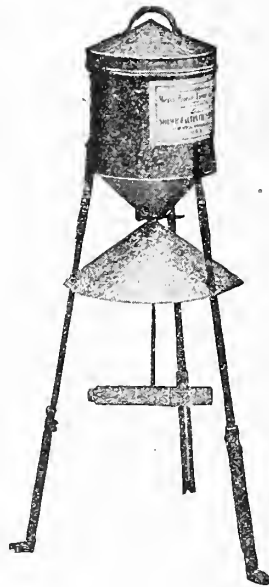

PARCEL POST EGG BOXES

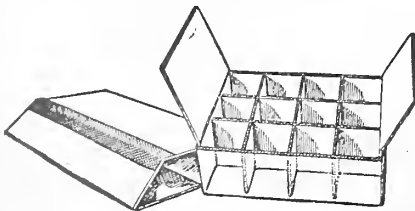

This shipping package is so constructed that each egg is separated by a thickness of corrugated board and the entire contents are surrounded by a double wall of air-cushioned board. Absolute protection is therefore assured, as the box possesses sufficient strength and durability to stand the usual rough handling in transit.

Capacity	Each	Doz.	Capacity	Each	Doz.
1 doz.	\$0.15	\$1.50	4 doz.	\$0.35	\$3.50
2 doz.	.25	2.25	5 doz.	.40	4.25
3 doz.	.30	3.00			

Metal (Aluminized) Egg Shipping Box

This is the ideal, indestructible box for forwarding household eggs by parcels post or express; can be used an indefinite number of times.

2-dozen capacity... \$1.00 each
3-dozen capacity... 1.25 each
4-dozen capacity... 1.50 each
6-dozen capacity... 1.75 each

Combination butter and egg box, \$1.75 each.

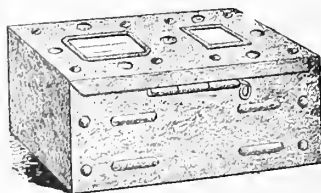

Aluminized Egg Box



NORWICH CHICK FEEDER

Convex in shape, it is impossible for the chicks to pull out or scatter the feed; the removable guard rod prevents the chicks from getting into the feed. The body is of galvanized steel with ends riveted and burred to malleable iron brackets. Will last a lifetime with ordinary care. 20 inch. Weight 3 pounds.

Without Rain Top, each... \$0.75 With Rain Top, each... \$1.00

Galvanized Iron Grit, Shell and Feed Boxes

No. 1. Medium, with three spaces, 75c. each.
No. 2. Large, with three spaces, \$1.00 each.

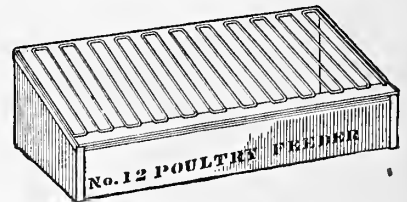

FELKER'S No. 12 FEEDER

Designed especially for a small colony of fowl or for chickens. Can be used for any kind of grain feed or mash and is protected from waste by a specially designed brass wire gird. Can be hung on the wall or set on a sill. 12-in. long, \$1.00 each; weight, 3 lbs. each; 24-in. long, \$1.50; weight, 5 lbs. each.

PHILADELPHIA POULTRY FOUNTAIN

From a sanitary standpoint, this is one of the best drinking fountains.

The top or body is detached; it is thus easily cleaned. The cone top prevents roosting. Made of heavy galvanized iron.

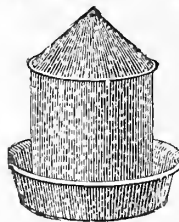

Capacity	Each
1 quart	\$0.30
2 quarts	.45
4 quarts	.60
8 quarts	.85

Extra Pans for Philadelphia Founts. 1 qt. size, 15c. each; doz., \$1.50. 2 qt. size, 20c. each; per doz., \$2.00. 4 qt. size, 25c. each; per doz., \$2.50. 8 qt. size, 30c. each; per doz., \$3.00.

NORWICH AUTOMATIC AIR-LOCK FOUNTAIN

The most perfect device ever placed on the market for automatically supplying pure, fresh water in the poultry house. It is absolutely impossible to contaminate or pollute the water supply, and requires cleaning only about once in three months. Guaranteed frost-proof to 10 degrees below zero, and has been operated at temperatures of fifteen and twenty below without being affected. Fitted with detachable cup, removable oil chamber, heat generator, etc.

Made in one size only, 5 gallons capacity. Shipping weight, 15 lbs.

Complete, with burner base... \$6.00
Without burner base... 3.50
Burner base only... 3.50

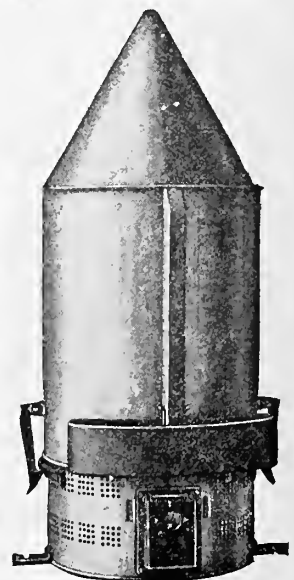

See our catalog of Poultry supplies for a complete list of Founts, Feeders and other poultry rearing devices, feeds, etc.

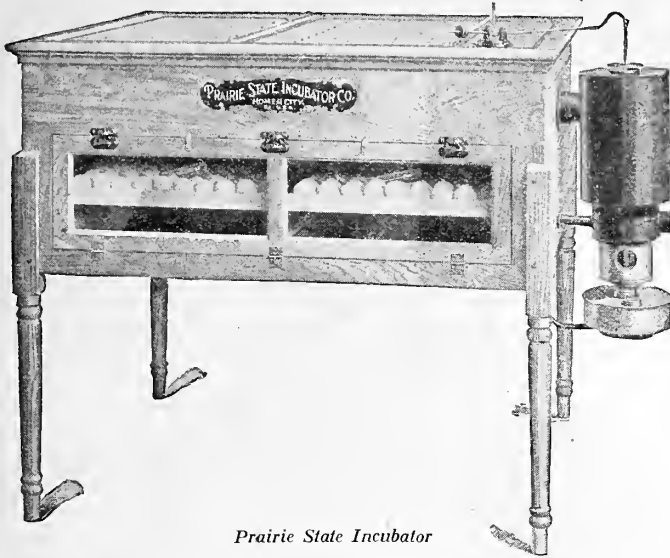

Prairie State Incubator

PRAIRIE STATE INCUBATOR

The Prairie State Incubators have made good since the day of their introduction, which is many years ago; the improvements that have been added are the results of developments which experience has proven to be both practical and successful.

In the building, design and construction of the Prairie State Incubator, every known factor to the present time has been taken into consideration. All Prairie State Incubators are equipped with nurseries.

In shipping the heaters are crated separately, as their design and size make it more practical; also it does away with the possibility of the heater becoming injured in transit.

There are also many other improvements in the Prairie State Incubator that a study of the Prairie State Catalog and a close inspection of the machine itself, if possible, will best reveal.

The Prairie State has the diffusive air circulation system and sand tray moisture feature and is as faultless as it is possible to make incubators.

Oil consumption per hour with outside temperature at 60° and incubator temperature at 103° per 24 hours

	Hen Egg Capacity	Duck Egg Capacity	Price
No. 0. Diffusive style... ¾ pt.	100	75	\$30.00
No. 1. Diffusive style... 1 pt.	150	100	37.50
No. 2. Diffusive style... 1½ pts.	240	200	52.50
No. 3. Diffusive style... 1¾ pts.	390	300	67.50

Complete Catalog on Prairie State Incubators and Brooders free on request.

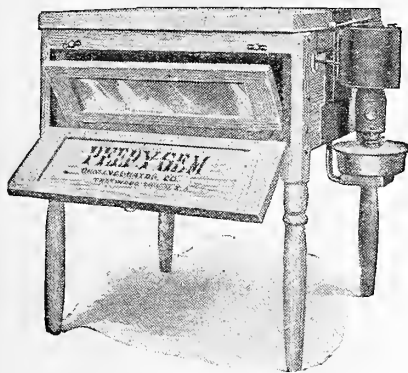

Peepy Gem Incubator

PEEPLY GEM HOT WATER INCUBATOR

This is especially designed for the amateur or beginner. It is a wonderful value for the price charged. Very carefully made. Equipped with galvanized water heater and a sensitive thermostat. We can supply this in one size only, 50-egg capacity, \$10.00.

Chick Boxes

Made of corrugated paper; extensively used; will carry chicks any distance with perfect safety. Are shipped knocked down and take up a small amount of space.

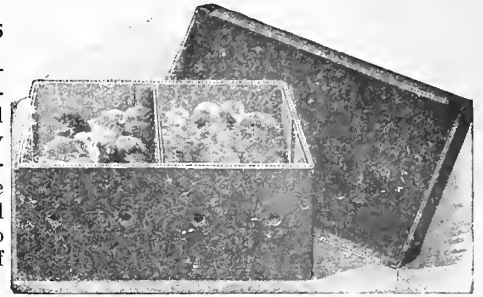

Capacity	Size	Each	Doz.
25 Chicks	12 x 6 x 5	\$0.25	\$2.25
50 Chicks	12 x 12 x 5	.35	3.50
100 Chicks	24 x 12 x 5	.45	4.25

THE GATE TRAP NEST FRONT

A trap worked entirely by the hen, arresting it every time it enters the nest. Of simple construction; cannot get out of order, must last a lifetime, will never frighten a hen. If you use trap nests you can tell which hens are layers and which are drones.

Please note we furnish fronts only, made of all metal, attachable to a square box of suitable size.

Each, \$1.00; \$11.50 per doz.

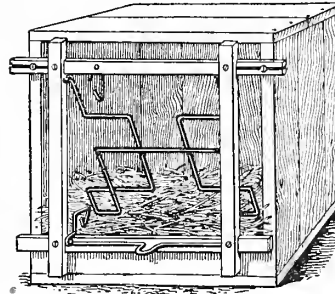

COLLINS OAT SPROUTER

The most practical, quickest growing, perpetual, sectional and fireless Oat Sprouter. The Collins Sprouter is made in units; light individual pans, one pan for each day of the week and a drip pan at the bottom.

The production of eggs and the proper development of growing stock depend upon some form of "green stuff," something that is growing, that has life in it. The feeding of sprouted oats is no longer an experiment. Experience has proven time and again its value as a food for stimulating egg production. Oats sprouted in the right manner furnish food most nearly akin to the fresh green growth of spring time, the prolific laying time of the year. By feeding sprouted oats through the winter, egg production can be kept up to a much larger degree than otherwise.

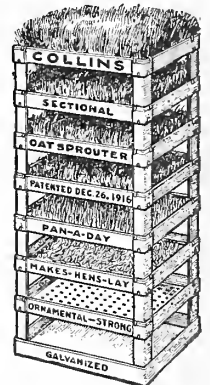

Collins Oat Sprouter

No.	Price
No. 1.—11 x 15"—5 Pans	\$3.00
No. 2.—11 x 15"—8 "	4.00
No. 3.—11 x 32"—8 "	8.00

SALT BRICKS

For dairy cows, horses and other animals. Essential to general good health in stables; fastened on the wall it is accessible at all times and remains clean. Per brick, 25c.; \$2.75 per dozen. P. P. Weight, each, 5 lbs. Salt Brick Holders, 50c. each; doz., \$5.00. P. P. Weight, 3 lbs.

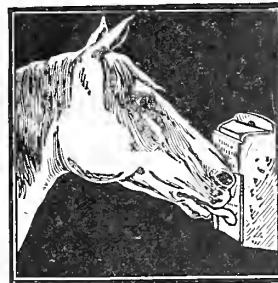

RICHMOND BUTTER CHURNS

First quality white cedar, carefully finished, easily cleaned. You can make butter according to the amount of milk or cream on hand.

No. 1.	3 gals.	\$4.00
No. 2.	4 gals.	4.50
No. 3.	7 gals.	5.25

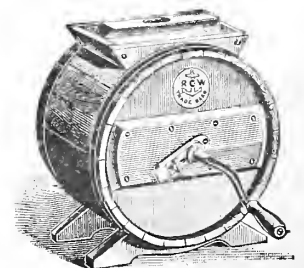

Butter Churn

MICHELL'S RELIABLE POULTRY SUPPLIES

PRAIRIE STATE JR. COAL STOVE BROODER No. 1

The Junior is the result of an effort to put a moderately priced equipment in the hands of poultrymen who want a good Stove Brooder. It is compact in design, occupies small floor space and is adaptable to every possible brooding condition.



It is fitted not only for permanent installation, but is also portable, so that being installed in one house, after the brooding stage is passed it may be picked up and carried all intact to another house to begin with another flock. It is durable, substantial and low in cost of operation. The stove is solid cast iron, resting directly on its base without legs, there being no hot place under the stove possible for the chicks to reach. Designed for hard coal, but will burn soft coal also. The

canopy is of galvanized sheet steel, hinged in centre, giving ready access to stove when coaling. Regulator is powerful, sensitive, triple control, of wafer type, regulating temperature to a fraction of a degree, with all working parts under canopy and so protected. The device handles flocks of 250 to 1000 or more safely and is adaptable to permanent or portable brood houses. This brooder can be operated at a cost of from 7 to 14 cents per day for coal. Price, complete with equipment, \$25.00.

PRAIRIE STATE JR. No. 0 COAL STOVE BROODER

The construction of this is similar to the Junior Coal Stove Brooder No. 1, excepting that it has a new design double control regulator instead of the triple control type. Capacity, 200 to 700 chicks. Price, \$20.00.

THE HOME HATCHER HOVER

Especially designed to meet the requirements of the raiser of a small flock of poultry. Substantially built and of fireproof construction throughout. With the exception of the legs, the entire hover, including the lamp, is made of heavy galvanized iron. It is fitted with a lamp for which a separate housing is provided. An ideal hover for baby chicks. Capacity, 50 chicks. Price, \$7.00.

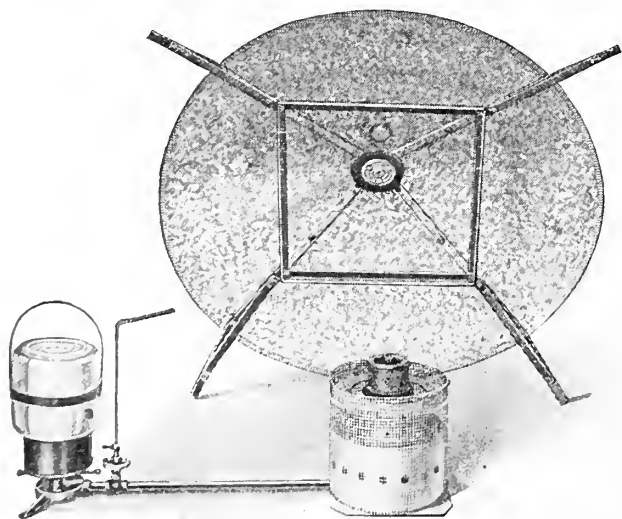

Sol-Hot Oil Burning Brooder

Get our Poultry Supplies Catalog, free at the store or mailed upon request.

EUREKA COAL STOVE BROODER

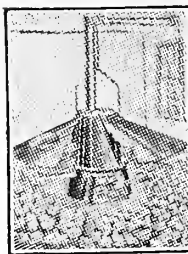

This type has a corrugated fire pot claimed to be gas proof; is self regulating and the manufacturer claims you can operate it at a cost of 5 cents per day. It requires no attention except coaling once in 24 or 48 hours, according to weather. The "Eureka" is made in Philadelphia and is sold at a very attractive price because the capacity for manufacturing them is large and conditions favorable. Made in two sizes: No. 10, weight 95 lbs., for brooding 500 chicks, \$21.50; No. 20, weight 117 lbs., for brooding 1000 chicks, \$26.50.

PUTNAM BROODER HEATER

This can be used in any home-made brooder. The heater is so constructed that it acts like an open fireplace, carrying the foul air out and drawing the fresh air in, thus providing perfect ventilation automatically. Heat is radiated from above onto the backs of chicks, giving the natural and soothing effect of the hen, without the lice. The brooder heater is made of brass and galvanized iron and is practically indestructible. Every brooder heater is accompanied by easily followed directions for building the home-made brooder. Price of heater, \$4.75.

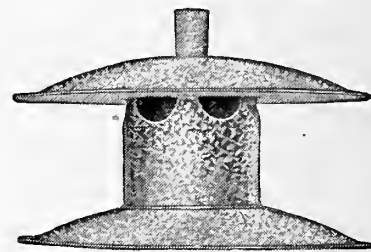

LITTLE PUTNAM STOVE

This is used under the drinking vessels of the poultry house to keep the water from freezing in the coldest winter weather. The

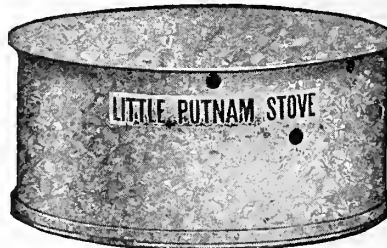

stove is nine inches in diameter and four inches high; made of galvanized iron and equipped with a burner which embodies an entirely new principle in oil combustion. Combustion is complete and perfect, doubling the heat value of the oil. The oil tank holds three pints of oil and burns three to four

weeks without refilling or any other attention; the wick never needs trimming. Price, \$2.00.

SOL-HOT IMPROVED BROODER

The new Improved Sol-Hot embodies the fundamental principles that are absolutely necessary in a heater for the successful hatching and rearing of chicks, but in addition it has certain features that make it vastly superior, in fact a heater that is completely automatic and positively dependable day in and day out. It is the one and only heater on the market that is absolutely automatic. Once the burner is lighted it cannot go out as long as there is oil in the oil supply tank. The danger from fire caused by burners going out and oil continuing to flow through the burner and dropping down on the floor is entirely eliminated in the Sol-Hot because the oil stops the minute the flame is extinguished. In other words, the oil flows into the burner, but cannot flow any faster than the flame burns it.

You regulate the size of flame by raising or lowering the oil container; turning the oil container to the left raises the reservoir and increases the flame—turning to the right decreases the size of flame. The lever just below the oil container locks container, holding it in the desired position. When you have a Sol-Hot Heater you have the positive assurance that the flame in your heater will be burning just as you left it, except as it varies to meet the changing weather conditions. You need never worry about the flame dying down or going out in the night—this positively cannot occur with the Sol-Hot.

32 inch Hover, Broods	250 chicks.....	\$15.75
42 " " " "	500 "	18.00
52 " " " "	1000 "	20.00

Complete descriptive circular on Sol-Hot Brooders free on request.

PRAIRIE STATE JR. PORTABLE HOVER

Combines all the essentials of the larger brooders in a style and size suited to the small producer or the fancier who wishes to raise small lots separately. While its size and capacity are equal to any other lamp brooder, yet it is light in weight and may be instantly moved from place to place. Heat is furnished by the Standard Prairie State Lamp set in the center of the hover, the warm, fresh air being diffused by the radiator under the galvanized steel hover top, down upon the chicks. Heat is controlled by the accurate regulator, and ventilation is assured by a perfect system of air flues. Curtain is of cotton duck; top of hover is insulated with mineral wool. Provides ample nursery space for 50 chicks. Price, \$10.00.

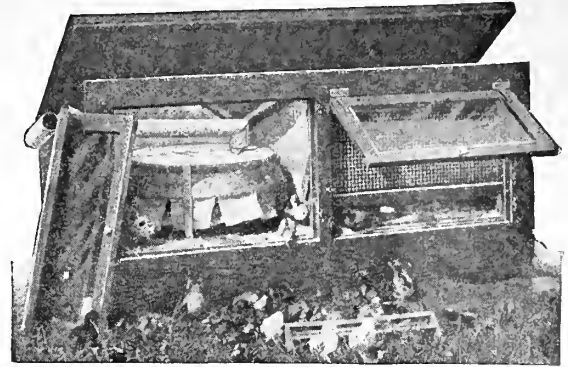

PRAIRIE STATE COLONY HOUSE

The Colony Brooder, with its dry, roomy quarters, level floors, overhead heat, graduated temperature, thorough ventilation and sun parlor for exercise, offers a happy solution to chick raising.

When the soil becomes worn out or if the location has become infected with disease or vermin, the removal of a portable colony brooder is an easy matter, and the birds can be given new quarters on fresh soil and amid new surroundings.

To transform the Combination Brooder into a Colony House, slip out the middle partition, remove the hover and lamp, and you have one of the neatest colony houses that could be built.

3 feet wide, 6 feet long, 3 feet high in front, 2 feet high in back (without heat regulator) \$35.00

"WIGWAM" SETTING and BROOD COOP

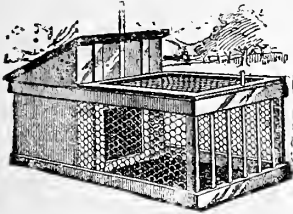

For a hen and her chicks or while she is setting. Gives protection from rats, skunks, hawks and other enemies. Insures larger hatches—fewer broken eggs. This coop is just the thing for colony raising and has proved its success for many years. Shipped knocked down.

Wigwam Brood Coop

	Length Incl. Yard	Width	Height of Coop	Floor Space of Coop	Each
Large.....	49 in.	22 in.	23 in.	18½ in. x 18½ in.	\$6.50

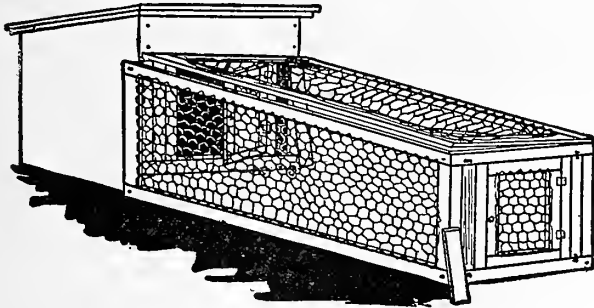

FARM BROOD COOP

A big, roomy coop that will accommodate a bunch of chicks. Well ventilated; substantially made; shipped knocked down. Made from grooved and tongued lumber, not painted. It is 21 inches wide, 22 inches from front to back, 22 inches high in front, 14 inches in back. The roof is hinged. Then there is a wire run 38 x 21 x 16 inches. The top is hinged. Price, complete, \$6.25.

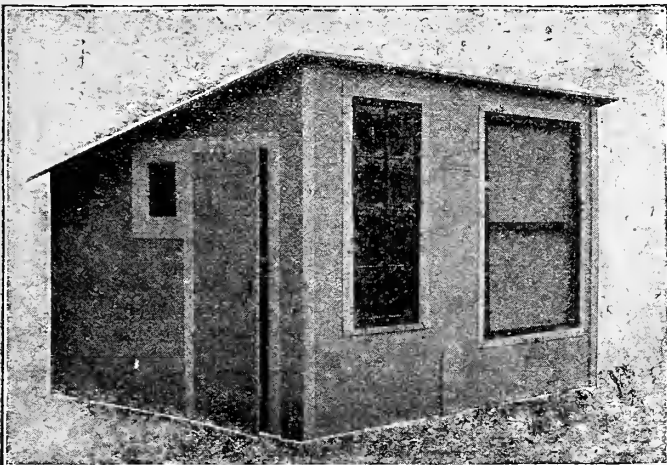

No. 5—Style D 1—Potter Poultry House

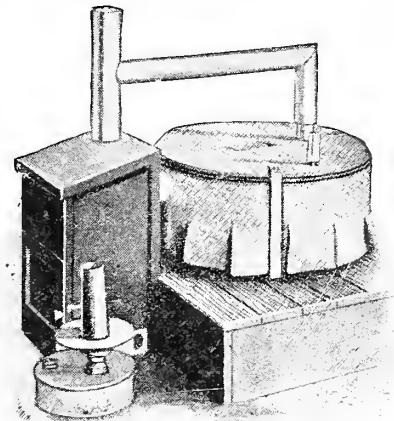

Universal Hover and Lamp Box for Outside Use

PRAIRIE STATE UNIVERSAL HOVER

As the name of this hover implies, it has a wide or universal sphere of usefulness. In fact, there is practically no limit to its adaptability. It may be used or attached to any form of outdoor brooder that is two feet or more in height; to any size or form of colony house, mushroom house, small portable building, dry-goods box, shed, coop, organ or piano box.

Where regular colony houses are used the Universal Hover can be attached to it until the chicks have been given a good start, and then removed to another for a new brood. It has proven to be thoroughly practical in actual service, giving perfect satisfaction during the coldest winter weather, changeable conditions of spring and the heat of summer.

Complete for outdoor use, with Lamp Case.....	\$9.00
Complete for outdoor use, with Regulator.....	10.50
Complete for indoor use, no Lamp Case.....	8.00
Complete for indoor use, with Regulator.....	9.50

POTTER PORTABLE POULTRY HOUSES

These are made in large quantities, of carefully seasoned lumber, which reduces the cost to the lowest minimum. The houses are shipped knocked down, and are put together with bolts and screws.

Please Note.—All Potter Poultry Houses are shipped from the factory, Downers Grove, Ill., near Chicago, and prices quoted on request will be based on purchaser paying the freight.

Prices of Poultry Food fluctuate constantly and will be quoted on application where prices are not mentioned.

For Bird Seeds and Supplies see Page 187.

- Alfalfa Hay.** Used as a scalded feed during the winter months.
- Alfalfa Meal.** Rich in protein and especially desirable for young birds. Splendid for feeding as a mash or for mixing.
- Animal Regulator (Pratt's).** For keeping farm animals in prime health and condition. 30c. and 60c. per pkt.; 12 lbs., \$2.50.
- Barley.** Principally fed for making feathers and bone.
- Bone (Coarse Ground).** For feeding grown fowls. For muscle making, producing eggs and as a digester.
- Bone (Fine Grade).** For feeding chicks and pullets and using in the mash.
- Bran (Wheat).** For mash, etc. An excellent egg maker and very nutritious. Can be fed alone or used in a mixture.
- Broken Rice.** For small chicks and for conditioning stock which has been allowed to become in a run down condition.
- Buckwheat.** Fed very largely as a change of diet. Especially good for winter feeding.
- Cake Meal.** For mixing in the mash. Splendid for use during the moulting season.
- Calf Meal (Blatchford's).** For weaning calves from cows and taking the place of milk. Fed in liquid form.
- Canada Peas.** Principally fed to pigeons, when it acts as a bowel regulator. Should not be fed continuously.
- Cat Food (Spratt's).** Saves the necessity of especially preparing food for tabby. Per large carton, 35c.
- Catnip Balls.** A plaything and tonic for pussy. 15c. each.
- Charcoal.** Two grades, **fine** and **coarse**. Disinfects the bowels and tones up the whole system. Usually fed from a hopper alone or used in dry or wet mash.
- Chicgrain (Spratt's).** Can be used as the staple food from the very day the chick is hatched. Claimed to be the most scientifically balanced chick ration.
- Chick Food (Michell's).** Made from clean, wholesome grains. Properly balanced and proportioned.
- Chick Food (Park and Pollard).**
- Chick Food (Pratt's).** For newly-hatched chicks.
- Chick Manna.**
- Chick Meal (Spratt's No. 5 and No. 3).** For show or prize stock; develops strong, husky specimens.
- Condition Powder (Sheridan's).** A natural stimulant and persuader for the hen.
- Condition Tablets (Pratt's).** For keeping poultry in prime health. 25c. and 50c. per pkg.
- Conkey's Laying Tonic.** To be mixed with the mash. 25c. pkg.
- Conkey's Starting Food for Baby Chicks.** Contains bone and muscle making properties in the highest degree. Can be used in dry or wet mash form.
- Corn Meal (Special Process).** Suitable for either mash or feeding little chicks. Carefully ground and sifted.
- Cracked Corn.** Carefully sifted; fine or coarse. All coarse and dirty particles removed.
- Cut Clover Hay.** Excellent for using in mashes, taking the place of green food.
- Developing Food (Michell's).** A mixture of grain that is fed from the time chicks are 3 weeks old till they are 3 months old. Desirable also as a scratching litter for young chicks.
- Dog Cakes (Spratt's).** Dog cakes are made so that they supply every requirement of the dog's need for sustenance. No cooking or mess.
- Dog Cakes (Maltoid Milkbone).** Shaped like a bone, which seems to appeal to most dogs.

Price Notice. Where we have not quoted prices please ask for them, the many constant changes, make it more practical to omit them.

- Fish, Dried Ground.** Splendid for egg production. Desirable to feed alone or in a mash.
- Gluten Meal.** For feeding to both poultry and cows.
- Grit.** Fine, medium and coarse. This is necessary and aids digestion in fowls of all kinds.
- Grit (Red Cross Health).** For pigeons. Contains a variety of materials including seeds of some aromatic herbs.
- Ground Oats.** This makes an excellent dry food when combined with other similar ration.
- Growing Food (Park and Pollard).** Feed when chicks are developing. Park and Pollard foods are regarded as the best of their respective kinds.
- Hemp Seed.** Fed largely to pigeons, also to poultry during winter months; should not be fed continuously.
- Hulled Oats.** A splendid food for young chicks, as a change of diet or after they have been hatched a few days.
- Kaffir Corn.** Makes a fine food for pigeons, also used for poultry; very good for feeding during winter months.
- Linseed Meal.** For feeding with the regular ration during the moulting period; splendid for conditioning birds in preparing to exhibit them.
- Mash Food (Michell's Buttermilk).** Rich in bone, muscle and feather making elements; makes chicks and fowls thrive.
- Mash Food (Park and Pollard).** (*Lay or bust.*) Reputed to be the best mash food on the market.
- Mash Food (Buttermilk).** For chicks. A specially prepared mash to develop quick growth in young stock.
- Meat (Prepared).** Very rich in protein. If you want eggs in winter, poultry meat will get them for you, if placed before the fowls where they can eat it at will.
- Middlings.** An excellent change in combination of a mash.
- Millet (For Feeding).** Highly nutritious and used extensively for pigeons and young chickens.
- Oat Meal (Pin Head).** An excellent food for young chicks after they are a few days old and may be continued until they are several weeks old.
- Oyster Shells.** Fine and coarse. State which is wanted when ordering. Oyster shells contain shell making properties.
- Panacea (Poultry Tonic).** Made by Drs. Hess and Clark, who have a splendid reputation for making reputable poultry supplies. 1½ lbs., 25c.; 75c. per 5 lbs.; 12 lbs., \$1.50.
- Pheasant Meal (Spratt's).** No. 12 Fine; No. 5 Coarse. State which is wanted when ordering. Especially combined to furnish the peculiar feed requirements of pheasants.
- Poultry Food (Spratt's No. 3).** A splendid egg producer.
- Poultry or Scratch Food (Michell's).** An evenly balanced grain ration for feeding growing and adult fowls.
- Poultry or Scratch Food (Park and Pollard).** A carefully prepared food.
- Pratt's Poultry Regulator.** A general conditioning tonic to be fed in the mash. Price, 8 oz. package, 12c.; 24-oz., 25c.; 50c. per 4 lbs.; 12-lb. bag, \$1.40; \$1.65 per 12-lb. pail; 25 lbs., \$3.00; \$10.00 per 100 lbs.
- Prepared Pigeon Food.** An excellent mixture of grain. Pigeons thrive better on specially prepared feed.
- Puppy Cakes (Spratt's).**
- Puppy Cakes (Maltoid Milkbone).** A pup requires feed that will meet its needs for body, muscle and bone building. Requires no cooking and makes no dirt.
- Salt Cat.** A tonic for pigeons. Combined with aromatic herb seeds. 25c. per brick; per doz., \$2.75.
- Sunflower Seed.** For poultry, parrots, etc. Per lb., 15c.; 70c. per 5 lbs.; 10 lbs., \$1.35; \$3.25 per bu. (25 lbs.)
- Vetches or Tares.** For pigeon feeding. Ask for quotations.

SPECIAL NOTE

We publish a complete Catalogue on Poultry Supplies which is free on application.

MICHELL'S POULTRY REMEDIES, LICE DESTROYERS, 185 DISINFECTANTS, ETC.



Carbola. An improvement on white wash, combining the features of a cold water paint and disinfectant; will not rub or chop; not a lime product. 30c. per 2 lbs.; 10 lbs., \$1.25; \$5.00 for 50 lbs.

Carboletta. A carbolic solution for painting

roosts, spraying, etc. 40c. per qt.; ½ gal., 65c.; \$1.00 per gal.

Carbolineum (Genuine S. P. F.). A poultry house disinfectant, louse and mite destroyer; excellent wood preservative; in gallon cans only. \$1.50 per gal.; 5 gals. for \$7.00.

Chemo. A liquid lice killer that will not discolor the plumage of white poultry. Per gal., \$2.00.

Condition Tablets (Pratt's). 25c. and 50c. per pkg.

Conkey's Canker Special. A wonderful and effective remedy. 50c. per pkg.

Conkey's Cholera Cure. 25c. and 50c. per pkg.

Conkey's Chicken Pox Remedy. 25c. and 50c. per pkg.

Conkey's Gape Cure. For young chicks. 50c. per pkg.

Conkey's Lice Fix. For destroying mites, lice, etc. 50c.

Conkey's Lice Killer (Liquid). For painting roosts, poultry houses, spraying nests and general vermin cleaning, etc. Qt., 60c.; 90c. per ½ gal.; 1 gal., \$1.50.

Conkey's Lice Powder. A sure destroyer. 25c., 50c. and \$1.40 per pkg.

Conkey's Noxi-cide. A germ destroyer, which will keep the poultry house in a pure, sanitary condition, destroy all germs and drive out the lice and mites. 45c. per pt.; qt., 70c.; \$1.15 for 2 qts.; gal., \$1.80.

Conkey's Roup Cure. The most widely used of the roup remedies; administered in the drinking water. 25c., 50c. and \$1.00 per box.

Conkey's Scaly Leg Remedy. A sure cure. 25c. per pkg.

Conkey's White Diarrhoea Cure. For little chicks; results always satisfactory. 25c. and 50c. per package.

Death to Lice (Lambert's). For dusting fowls and nests. The most effective chicken lice exterminator in existence. 5-oz. size, 10c.; 25c. for 15 ozs.; 48 ozs., 50c.; \$1.00 per 100-oz. pkg.

Death to Lice Ointment. A salve or ointment used on the heads of newly-hatched chicks. It drives away lice instantly. Easily applied; no mess; no trouble. 10c. and 25c. per box.

Gape Worm Extractors. Two styles: Hallowell, made of German silver and horse hair, 10c. each. Pilling, made entirely of German silver, 25c. each.

Germozone (Lee's). The standard remedy for the prevention and cure of most every ill that affects poultry, such as roup, cholera, bowel complaint, diarrhoea, sore head, gapes, etc. Germozone's greatest value is in preventing sickness. In tablet form, 75c.

Lice Expelling Nest Eggs. These are made of naphthaline and are an ideal substitute for the natural egg, which they closely resemble. 6c. each; per doz., 65c.; \$4.50 per 100.

Oculum. For cholera, roup and diarrhoea. May be used on chicks and grown fowls with equal success. 50c. and \$1.00 per bottle.

Persian Insect Powder. This is probably the oldest lice expelling powder in existence. ¼ lb., 35c.; 60c. per ½ lb.; lb., \$1.10.

Pratt's Disinfectant. For spraying poultry houses, stables, etc. It gets rid of lice and mites and keeps poultry houses clean and healthy. 60c. per qt.; ½ gal., \$1.05; \$1.70 per gal.

Pratt's Lice Powder. For dusting nests, fowls, chicks, etc.; quickly kills the lice. 15c., 30c. and 60c. per box.

Pratt's Roup Remedy (Pills). For roup, canker, catarrh and diphtheria. As a preventative it is unsurpassed. 25c. and 50c. per box.

Pratt's Sore Head Remedy. A sure, rapid cure for the dreaded disease known as sore head or chicken pox. 35c. and 70c. per box.

Pratt's White Diarrhoea Remedy. For baby chicks; keep the germs of the disease from becoming active by using this remedy. 25c. and 50c.

Roup Syringe. For administering liquid roup remedies in the nostrils or throat. Price, 15c. each.

Spratt's Dog Soap. Entirely free from poison, and at the same time most effective in the destruction of lice and fleas. 25c. per cake.

Sulphur Candles. Large size, 30c. each; per doz., \$3.00. Small size, 20c. each; per doz., \$2.00.

Tobacco Dust. For dusting on roosts, nests, etc., to keep away vermin. 10c. per lb.; 5 lbs. for 40c.; 60c. for 10 lbs.; 25 lbs., \$1.35; \$2.50 per 50 lbs.; 100 lbs., \$4.75.

Tobacco Stems. For making nests, etc. 10c. per lb.; 5 lbs., 40c.; \$1.00 per bushel; per bbl. bag, \$1.75; in large bales of about 250 lbs., at 2½c. lb.; per ½ ton, \$17.00; \$32.00 per ton.

Whiting's Roupene. An infallible preventive and sure cure for all cases of roup, canker, diphtheria, chicken pox or sore head, gapes, colds and all diseases of the respiratory organs of fowls or pigeons. Will cure dogs of the sniffles. Price, 50c. and \$1.00 per bottle.

Whiting's White Diarrhoea Remedy. 50c. and \$1.00 per bottle.

Zenoleum Lice Powder. For dusting hens and nests; fine for brooding hens. 35c. per 16-oz. pkg.

Zenoleum Liquid. Dilute one part Zenoleum to one hundred parts water. It is non-poisonous and is not irritating or inflammable. Should be used freely around barns and poultry houses. Zenoleum is a concentrated solution of coal tar. It is mixed with hot or cold water, making a perfect emulsion that requires no boiling or stilling. 8 ozs., 35c.; 75c. per qt.; ½ gal., \$1.25; \$2.00 per gal.; 5-gal. can, \$9.50.

RAT CORN



It mummifies the Rodents, eliminating nauseous odors. It will not kill human beings and is generally not harmful to domestic animals.

One of the most repulsive scourges humanity has to fight is the rat. He has killed millions of human beings

by Bubonic Plague infection. He destroys over \$500,000,000 worth of property in the United States alone. He is a constant menace and danger to the human race. **RAT CORN** is a sure rodent exterminator, but there is no danger of fatalities, accidents or otherwise, and disagreeable odors are unknown. 3 oz. pkgs., 25c.; 8 oz. pkgs., 50c.; 13 oz. pkgs., \$1.00.



ZENOLEUM VAPORIZING LAMP

A new method of destroying vermin in poultry houses; has the same beneficial effect as spraying except it is accomplished with much less effort and if anything, is more effective. Price for Lamp, 85c. (P. P. 10c. extra).

Vaporizing Lamp

MICHELL'S FLOWER POTS, TUBS, ETC.

Orchid Pan Earthen Fern Pan Fern Dish Liner Seed Pan Wood Fibre Flower Vase



Cedar Tub Keystone Tub Earthen Flower Pot Azalea Pot Earthen Bulb Pan Earthenware Saucer Wood Fibre Saucer Rolling Stand

CEDAR TUBS

Equipped with Strong Iron Handles
These are made by hand, of the very best white cedar, painted green, bound with black iron hoops.

No.	Inside Diam.	Each
No. 0	24 3/4 in.	\$11.15
No. 1	23 3/8 "	9.90
No. 2	21 3/8 "	8.85
No. 3	18 11/16 "	7.20
No. 4	16 1/2 "	5.85
No. 5	14 7/8 "	5.50
No. 6	12 1/8 "	4.20
No. 7	11 3/4 "	3.70
No. 8	10 1/8 "	3.20

MICHELL'S KEYSTONE PLANT TUBS

Made of white cedar, painted green and bound with strong electric welded wire hoops, which do not rust. Handles are sold separately at 30c. per pair, not attached to tub.

No.	Inside Diam.	Depth	Each
No. 1	6 in.	6 in.	\$0.70
No. 2	7 "	7 "	.75
No. 3	8 "	8 "	.80
No. 4	9 "	9 "	.85
No. 5	10 "	9 "	.95
No. 6	11 "	10 "	1.25
No. 7	12 "	11 "	1.50
No. 8	13 "	12 "	1.90
No. 9	14 "	13 "	2.20
No. 10	15 "	14 "	2.35
No. 11	16 "	15 "	2.70
No. 12	17 "	16 "	3.15
No. 13	18 "	17 "	3.75
No. 14	19 "	18 "	4.50

ROLLING STANDS for Tubs, Pots, etc.

Ins.	Weight	Pot	Tub	Each	Doz.
12	2 lbs.	12 in.	No. 8.	1.25	14.00
14	2 1/2 lbs.	12 in.	No. 7-6.	2.10	24.00
18	3 1/2 lbs.	16 in.	No. 7-6.	2.10	24.00
22			No. 4.	2.65	30.00

PAPER FLOWER POTS

Ins.	Parcel Post Weight	per doz.	per 100	Doz.	100	1000
2 1/4	3 ozs.	2 lbs.	\$0.12	\$0.50	\$4.45	
2 1/2	3 "	2 "	.15	.60	5.15	
3	5 "	2 "	.18	.80	7.05	
3 1/2	7 "	3 "	.20	1.00	9.15	
4	8 "	4 "	.25	1.30	11.40	
5	15 "	7 "	.30	2.00	17.75	
6	2 lbs.	11 "	.45	2.70	21.75	

AZALEA POTS

Diam.	Depth	Each	Doz.	100
5 in.	4 1/2 in.	\$0.07	\$0.65	\$4.86
6 "	5 "	.09	.98	7.29
7 "	6 "	.15	1.62	12.15
8 "	7 "	.22	2.34	17.55
9 "	7 1/2 "	.33	3.60	27.00
10 "	8 "	.45	4.86	36.45
12 "	10 "	.91	9.90	74.25

FERN DISH LINERS

Very shallow, for inside of fancy silver or porcelain ferneries.

Width	Depth	Each	Doz.	100
7 in.	1 1/8 in.	\$0.22	\$2.16	\$14.40

SEED PANS (Earthenware)

	Each	Doz.
6 inches square	\$0.83	\$9.00
8 "	1.11	12.06
10 "	1.38	15.12
12 "	1.65	18.00

EARTHEN BULB PANS

	Each	Doz.	100
6 inches diam.	\$0.09	\$0.98	\$7.29
7 "	.15	1.62	12.15
8 "	.22	2.34	17.55
9 "	.33	3.60	27.00
10 "	.45	4.86	36.45
12 "	.91	9.90	74.25
14 "	1.48	16.20	121.50

WOOD FIBRE FLOWER VASES

No.	Diam.	Depth	Weight	Each	Doz.
0	8 in.	13 in.	4 lbs.	\$1.65	\$18.60
1	5 1/2 "	10 "	2 1/2 "	1.40	16.20
2	4 1/2 "	9 "	1 1/2 "	1.25	14.40
3	4 "	6 "	1 1/2 "	1.10	12.60
4	3 "	4 1/2 "	3/4 "	.90	10.20
11	5 "	18 "	4 "	1.95	22.00
22	4 1/2 "	15 "	2 "	1.75	20.00
33	4 "	12 "	2 "	1.60	18.00
44	3 "	9 "	1 "	1.25	14.00

CUT FLOWER VASES (Galvanized Iron)

No.	Top Diam.	Depth	Cap.	Each
65	7 1/2 in.	8 in.	8 Qt.	\$0.50
66	8 3/4 "	10 "	10 "	.65
67	7 3/4 "	12 "	12 "	.75
68	8 3/4 "	12 1/2 "	14 "	.85
69	8 3/4 "	18 "	16 "	1.00

EARTHEN FLOWER POTS

Height and	Width inside	Each	Doz.	100	1000
1 inch		\$0.02	\$0.17	\$1.22	\$11.48
2 "		.02	.18	1.02	9.56
2 1/4 "		.02	.18	1.16	10.84
2 1/2 "		.02	.18	1.35	12.75
3 "		.03	.24	1.76	16.58
3 1/2 "		.03	.29	2.16	20.40
4 "		.04	.36	2.70	25.50
4 1/2 "		.06	.49	3.65	34.43
5 "		.07	.65	4.86	45.90
5 1/2 "		.08	.81	6.08	57.38
6 "		.09	.98	7.29	68.85
6 1/2 "		.13	1.30	9.72	91.80
7 "		.15	1.62	12.15	
8 "		.22	2.34	17.55	
9 "		.33	3.60	27.00	
10 "		.45	4.86	36.45	
11 "		.66	7.20	54.00	
12 "		.91	9.90	74.25	
14 "		1.48	16.20	121.50	

EUREKA POT HANGERS

20c. each; doz. \$2.00; \$12.50 per 100.

KRICK POT HANGERS

No.	Each	Doz.
No. 1	\$0.07	\$0.70
No. 2	.08	.80
No. 3	.09	.90

WOODEN ORCHID BASKETS (Square)

	Each	Doz.
4 inch	\$0.50	\$5.00
10 "	.75	7.50
12 "	1.00	10.00

ORCHID PANS (Round) (Earthen)

	Each	Doz.
4 inches diam.	\$0.35	\$3.50
6 "	.45	4.50
8 "	.55	5.50
10 "	.75	8.00
12 "	1.25	12.00

EARTHEN FERN PANS

Width	Height	Each	Doz.	100
4 in.	1 7/8 in.	\$0.06	\$0.54	\$4.05
4 3/4 "	2 1/8 "	.07	.72	5.40
5 1/2 "	2 1/4 "	.09	.90	6.75
6 1/4 "	2 1/2 "	.10	1.08	8.10
7 "	2 5/8 "	.12	1.26	9.45
8 "	3 "	.17	1.80	13.50
9 "	3 3/4 "	.20	2.16	16.20

EARTHENWARE SAUCERS

	Each	Doz.	100
4 inches	\$0.03	\$0.27	\$2.03
5 "	.04	.36	2.70
6 "	.06	.54	4.05
7 "	.07	.72	5.40
8 "	.10	.99	7.43
9 "	.14	1.35	10.13
10 "	.15	1.62	12.15
11 "	.19	1.98	14.85
12 "	.23	2.43	18.23
14 "	.37	4.05	30.38

WOOD FIBRE SAUCERS

Extremely desirable on account of being absolutely waterproof.

	Parcel Post Weight	Each	Doz.
5 inches	1/4 lb.	\$0.32	\$3.60
6 "	1/4 "	.34	3.90
7 "	1/2 "	.37	4.20
8 "	1/2 "	.39	4.50
9 "	3/4 "	.43	4.90
10 "	3/4 "	.46	5.30
12 "	1 1/4 lbs.	.55	6.30
14 "	1 1/2 "	.74	8.40
16 "	2 "	1.31	15.00
18 "	2 1/2 "	1.52	17.40
20 "	4 "	1.95	22.00

Larger sizes can be furnished as complete rolling stands only.

NOTE.—Earthenware cannot be packed for shipment by Parcel Post.

Comparatively few of us recognize the great economic value of birds. Particularly the bluebirds, house wrens and martins are very easily domesticated. Their favorite nesting sites are bird houses made for their use which may be placed about in the garden and farm or in orchards. As rent, these grateful birds pay amply, destroying millions of insects annually. If you put up bird houses in the autumn or before the birds arrive in the spring you may be able to keep some birds with you all winter if you provide them with shelter and food.



No. 11. Wren House.
Price, \$1.75. Wt., 3 lbs.
No. 12. Wren House.
Similar to No. 14.
Price, \$1.75. Wt., 3 lbs.

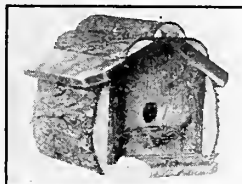

No. 13. Wren House.
Price, \$1.75. Wt., 3 lbs.

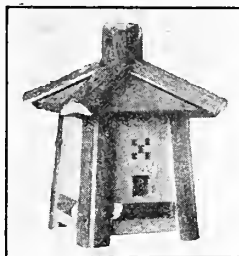

No. 61. Wren House.
Swinging.
Price, \$1.75. Wt., 3 lbs.



No. 28. The Wren "House Beautiful."
Price, \$2.00. P. P. Weight, 4 lbs.
No. 23. Wren House.
P. P. Weight, 3 lbs. Price, \$1.75.

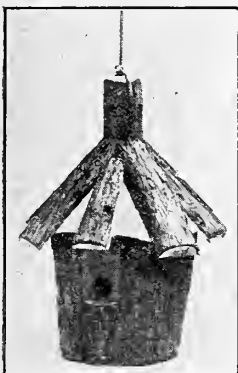

No. 14. Wren or Bluebird House.
Swinging.
Price, \$1.75. Wt., 3 lbs.

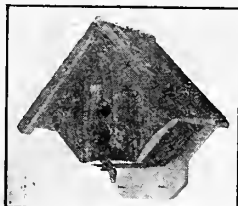

No. 17. Wren House.
Price, \$1.50. Wt., 3 lbs.

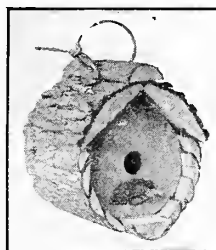

No. 50. Wren House.
Swinging.
Price, \$1.50. Wt., 3 lbs.

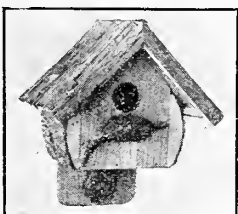

No. 62. Bluebird House.
Price, \$1.75. Wt., 3 lbs.

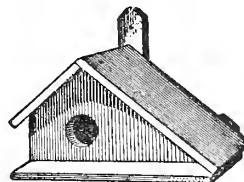

Maryland Wren Box.
Natural color, stained.
50c. each. P. P. Wt., 1 lb.

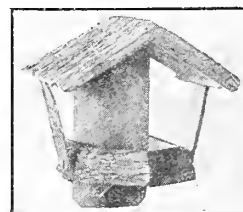

No. 60. Robin House.
Price, \$1.75. Wt., 3 lbs.

No. 21. Bluebird House.
Price, \$1.75. Wt., 3 lbs.

No. 63. Wren and Robin House.
Price, \$2.25. Wt., 3 lbs.



No. 8. 14 Room Martin House.
Price, \$20.00. Not mailable.



No. 78. 4 Room Martin House.
Price, \$5.00.

No. 25. For Woodpeckers, Chickadees, Nuthatches, etc.
Price, \$1.75.
Weight, 3 lbs.

WIRE SPARROW TRAP

We have tried this out and found it to be the best trap made. Scatter a little cracked corn and set trap right over it. You'll be surprised at the catch. \$6.00 each.

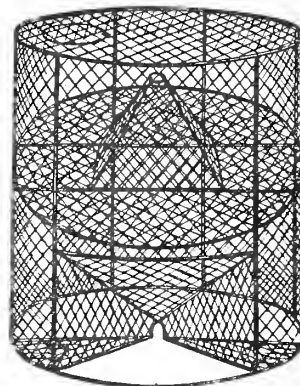

MICHELL'S RECLEANED BIRD SEEDS, PET SUPPLIES, ETC.

Our bird seeds are of the highest quality, fresh and recleaned. Your feathered pets will thrive if you get your supplies in this line from us.

	Lb.	5 lbs.	10 lbs.
Canary. Plain Sicily	\$0.15	\$0.65	\$1.15
Canary, Mixed	.15	.65	1.15
Hemp Seed	.15	.70	1.30
Millet Seed (Improved)	.12	.55	1.00
Rape Seed	.15	.70	1.30
Unhulled Rice	.25	1.10	2.00
Bird Manna. Keeps Canary Birds in prime condition. Pkg.,	15c.		
Cuttle Fish Bone. 5c. each; 1/4 lb., 20c.; 60c. per lb.			
Fish Food. For aquariums. 15c. per pkg.			
Lettuce Seed. 5c. per oz.; 1/4 lb., 10c.; 30c. per lb.			

Maw Seed. 1/4 lb., 10c.; 30c. per lb.; 5 lbs., \$1.40.
Parrot Food (Spratt's). 20c. per pkg., doz. pkgs., \$2.00.
Sand for Bird Cages. Fine, red or silver, 10c. per pkg.; doz. pkgs., \$1.00. Silver (coarse), 10c. per pkg.; doz. pkgs., \$1.00.
Song Restorer for Canaries, revives the desire to be lively and sing more lustily. Price, 15c. per bottle; per doz., \$1.50.
Prices on Bird Seeds Subject to Market Changes.

SUNFLOWER SEED

We are very large handlers of this important food for parrots. Our customers may depend upon getting a very choice article. 15c. per lb.; 70c. per 5 lbs.; 10 lbs., \$1.35; \$3.25 for 25 lbs.

MICHELL'S INSECT DESTROYERS, ETC.

DIRECTIONS FOR USING ANY OF THE FOLLOWING WILL BE FOUND ON EACH PACKAGE



Ant Exterminator. A powder that is used for distributing around buildings, on greenhouse benches, on lawns, gardens, and any other places infested by ants. Per $\frac{1}{4}$ lb., 30c.; 50c. per $\frac{1}{2}$ lb.; lb., 80c.; \$3.25 per 5 lbs.

Aphine. For destroying aphids, green fly, thrip, red spider and other greenhouse and outdoor insects. It dilutes readily in water about 1 part to 40 of the latter. Per $\frac{1}{4}$ pt., 25c.; 40c. per $\frac{1}{2}$ pt.; pt., 65c.; \$1.15 per qt.; per gal., \$3.25.

Aphis Punk. A paper that has been thoroughly saturated with nicotine. Used for fumigating, giving off dense fumes of nicotine. Excellent for aphids, thrip, white and green fly, also red spider. Contains 22 $\frac{1}{2}$ % of nicotine. Guaranteed effective if used within 6 months of the date on the container; each package contains 12 sheets, 33 x 6 inches or 16 $\frac{1}{2}$ sq. ft.; this is in excess of competitive products, so the Aphis Punk is the most economical product of its kind to use. (For use in greenhouses only.) Per pkg. of 12 sheets, 90c.; \$9.00 per case of 12 pkgs.

Arsenate of Lead (Paste). For spraying trees and shrubs against the attacks of leaf-biting insects of all kinds; especially valuable for spraying to prevent the codling moth; dilutes 1 lb. to 25 gals. water. Per lb., 45c.; \$2.00 per 5 lbs.; 10 lbs., \$3.75; \$7.00 per 25 lbs.; 50 lbs., \$13.50; \$26.00 per 100 lbs.

Arsenate of Lead (Powdered). 1 lb. to 1 $\frac{1}{2}$ lbs. dilutes to 50 gals. of water, or may be used dry, like Paris Green. Per lb., 55c.; \$2.50 per 5 lbs.; 10 lbs., \$4.75; \$10.00 per 25 lbs.; 50 lbs., \$18.50; \$35.00 per 100 lbs.

Black Leaf 40. Per 1 oz. bottle, 35c.; \$1.25 per $\frac{1}{2}$ lb.; 2 lbs., \$3.50; \$13.50 per 10 lbs.

Bordeaux Arsenate. A combined fungicide and insecticide, for fruit trees, potatoes, melons, cucumbers, etc.; also for mildew, black spots, etc., on roses. Per lb., 45c.; \$1.75 per 5 lbs.; 10 lbs., \$3.25; \$6.50 per 25 lbs.; 50 lbs., \$12.00; \$22.50 per 100 lbs.

Bordeaux Mixture (Paste). Used principally for mildew, blight and fungus diseases that affect potatoes and fruit trees; by adding water it is ready for use. In 5-gal. kegs only, price \$8.00.

Bordeaux Mixture (Dry Form). For dusting plants affected with mildew and all fungous diseases. Per lb., 30c.; \$1.25 per 5 lbs.; 10 lbs., \$2.00; \$4.25 per 25 lbs.; 50 lbs., \$7.50; \$14.00 per 100 lbs.

Boro Wax. For painting trees to destroy and keep away borers. Per qt., 55c.; \$2.00 per gal.; 5 gals., \$9.50.

Bug Death. Largely used instead of Paris Green. It is claimed to have the same effect. The manufacturers say that it acts as a fertilizer as well as an insecticide. It comes in powder form, and is applied pure. Not poisonous to persons. Per lb., 18c.; 45c. per 3 lbs.; 5 lbs., 75c.; \$1.50 per 12 $\frac{1}{2}$ lbs.; 100 lbs., \$8.75.

Clensel. An imported preparation for greenhouse and outdoor spraying for aphids, thrip, etc. Pint, \$1.00.

Copper Solution. Made of sulphate of copper and other materials. Excellent spray for carnation rust and diseases of the grape, pear, apple, and other fruits. A good thing to use for leaf blight and mildew. It is diluted in water. Per qt., \$1.50; \$4.00 per gal.

Cut Worm Destroyer. For killing cut worms, grubs, maggots and other insects that work in the soil. 5 lbs., \$1.40; \$4.75 for 25 lbs.; 100 lbs., \$17.50.

Cyanegg. For generating Hydrocyanic Acid Gas. Claimed to be the best remedy for killing white fly. Per lb., \$1.00. Cannot be mailed.

Dalmatian or Persian Powder. For ridding buildings of all kinds of insect pests, particularly roaches, ants, moths and fleas. Per $\frac{1}{4}$ lb., 40c.; 65c. per $\frac{1}{2}$ lb.; lb., \$1.25; \$5.75 per 5 lbs.

Fish Oil Soap (Good's Caustic). Used extensively as a tree spray and as a summer remedy for San Jose Scale; it comes in a soft soap form and is easily dissolved, 1 lb. to 10 gals. water. Per lb., 25c.; \$1.10 per 5 lbs.; 10 lbs., \$1.85; \$3.75 per 25 lbs.; 50 lbs., \$6.00; \$11.00 per 100 lbs.

Fish Oil Soap. An excellent summer spray, when something stronger cannot be used, where San Jose Scale exists. It is nice for washing off lemon trees, oleanders, and almost anything that would be infested with soft-shelled or in fact most any kind of insect. Dissolved in water according to various purposes. Per $\frac{1}{2}$ lb., 15c.; 25c. per lb.; 5 lbs., \$1.00; \$1.75 per 10 lbs.; 25 lbs., \$4.00; \$7.00 per 50 lbs.; \$11.00 per 100 lbs.

Fish Oil Soap (Rosin). Especially recommended for the destruction of boxwood maggot, bag worm and caterpillars. Per 5 lbs., \$1.50; \$2.75 per 10 lbs.; 25 lbs., \$4.50; \$7.50 per 50 lbs.; 100 lbs., \$12.50.

Flyosan. Quickly kills flies and other insect pests; applied with a sprayer. Per pt., 75c.; \$1.25 per qt.; $\frac{1}{2}$ gal., \$2.25; \$4.00 per gal.

Getz there Soap. Ideal for washing palms and spraying in place of Whale Oil Soap. 2 lbs., 65c.; \$1.75 for 8 lbs.; 25 lbs., \$3.75; 50 lbs., \$7.00.

Grape Dust. A powder preparation used for mildew, aphids, black fly, and other insects and fungous diseases, principally in greenhouse. Per 5 lbs., \$1.00; \$1.85 per 10 lbs.

Hellebore. The ideal material for destroying rose bugs, currant worms, and other soft-shelled insects that infest the garden. It can be applied dry or in liquid form. $\frac{1}{4}$ lb., 20c.; 40c. per $\frac{1}{2}$ lb.; lb., 70c.; \$3.00 per 5 lbs.

Insecticide (Zenke's). A powerful liquid contact insecticide, embodying the most effective elements which destroy most of the class of sucking insects lying on the leaf surface so as to be in reach of actual contact. Per 8 oz., 30c.; \$2.50 per gal.

I X L Compound. An English preparation for spraying; harmless to very delicate plants. Kills mealy bug, red spider and all insect pests. Per gal., \$7.50.

Kaylox. A powder that may be used as a wet or dry spray, for codling moth, potato bugs, most caterpillars and many leaf eating insects; as a general spray dilute 1 lb. to 5 gals. water; for specific use, dilute 1 lb. to 7 $\frac{1}{2}$ gals. water. Per $\frac{1}{2}$ lb., 35c.; 65c. per lb.; 5 lbs., \$2.75; \$5.00 per 10 lbs.; 25 lbs., \$11.00; \$21.00 per 50 lbs.; 100 lbs., \$40.00.

Kerosene Emulsion (Liquid) (Miscible Oil). Diluted in water this makes an excellent spray for all mild forms of scale, and soft lice of any kind such as infest rose and fruit bushes, vegetables and trees. Dilutes 1 part to 20 parts of water. Per pt., 50c.; 85c. per qt.; gal., \$2.25.

Lemon Oil Insecticide. The best and cheapest insecticide in the market. Used by nearly all the leading growers. It effectually destroys mealy bug, scale, thrip and red spider. Per $\frac{1}{2}$ pt., 35c.; 60c. per pt.; qt., \$1.00; \$1.75 per $\frac{1}{2}$ gal.; gal., \$3.00; \$12.00 per 5-gal. keg.

Lime Sulphur. For scale insects on trees and shrubs, and such fungous diseases as can be treated in winter or early spring; also for leaf curl of peaches. Per qt., 50c.; 75c. per $\frac{1}{2}$ gal.; gal., \$1.15; \$4.00 per 5 gals.; $\frac{1}{2}$ bbl. (30 gals.), \$12.00; \$16.00 per bbl. (50 gals.).

Lime Sulphur (Dry Powder Form). Dilute 1 lb. to 6 gals. of hot or cold water. Per lb., 35c.; \$1.40 per 5 lbs.; 10 lbs., \$2.25; \$4.75 per 25 lbs.; 50 lbs., \$7.75; \$15.00 per 100 lbs.

CARBONDALE HYDROMETERS

For testing the gravity of Lime-Sulphur solution; one should be in the hands of every man who uses this material. Price, \$1.25. (Postpaid, \$1.35.)

MICHELL'S INSECT DESTROYERS, ETC.

189

DIRECTIONS FOR USING ANY OF THE FOLLOWING WILL BE FOUND ON EACH PACKAGE

Mag-O-Tite. Protects crops against the ravages of the root maggot and other garden pests; also eradicates earth worms from lawns and putting greens. Not injurious in any way to plant life, but is a valuable stimulant and fertilizer. In powder form, ready for use. Per 2 lbs., 40c.; 65c. per 4 lbs.; 8 lbs., \$1.10; \$2.75 per 25 lbs.; 100 lbs., \$9.00.

Melrosine. An efficient Rose Bug remedy. A powerful and highly concentrated insecticide, used as a spray when diluted with from 20 to 25 times its bulk of water. Per ½ pt., 50c.; \$1.00 per pt.; qt., \$1.75; \$3.25 per ½ gal.; per gal., \$6.00; \$25.00 for 5 gals.

Mo Lo. A preparation for destroying and driving away moles. Per pkg., 25c.

Nico Fume (Liquid). For use as a spray or vapor, for controlling green fly, aphid, etc., in greenhouses and outdoors. Per ¼ lb., 75c.; \$2.25 per lb.; 4 lbs., \$8.00; \$15.00 per 8 lbs.

Nico Fume Paper. For fumigating greenhouses; gives off dense fumes charged with nicotine. Per box of 24 sheets, \$1.35; \$5.50 for 144 sheets; 288 sheets, \$10.00.

Nico-Fume Tobacco Powder. A tobacco powder highly charged with nicotine; splendid for fumigating greenhouses. Per lb. can, \$1.25; \$4.75 for 5 lbs.; 10 lbs., \$8.50.

Nicotine (Hall's) (40%). ½ lb., \$1.50; \$4.50 per 2 lbs.; per 8 lb. can, \$15.00.

Nicotine Fumigator (Hall's) (12½%). 1 lb. size, \$1.25; \$2.50 per 2½ lb. size; 10 lb. size, \$8.50.

Nikoteen (30%). One of the very best forms of tobacco or nicotine preparations; usually diluted in water; makes a most satisfactory spray as well as vapor. Per 1 oz. bottle, 25c.; 40c. per 1¾ oz. bottle; ½ lb. bottle, \$1.25; \$2.00 per lb.; 4 lbs., \$7.50; \$13.50 per 8 lbs.

Paris Green. A poisonous powder for potato bugs, worms, caterpillars, slugs, etc. It may be used in liquid form 1 pound in 50 gallons of water, or with Land Plaster at the rate of 1 pound Paris Green to 100 pounds Land Plaster. Per ¼ lb., 18c.; 35c. per ½ lb.; lb., 60c.; \$2.50 per 5 lbs.; \$6.25 per 14 lbs.

P. T. B. (Para-Dichlorobenzine). For peach tree borers; full directions on each package. Can be used successfully only during August and September, the makers claim it is not effective if used at other seasons. Do not use on very young trees. Ask for descriptive circular. Per 1 lb. can, 60c.; \$2.50 per 5 lb. can; 10 lb. can, \$4.00; \$8.00 per 25 lb. keg; 50 lb. keg, \$15.50; \$29.00 per 100 lb. keg.

Pyrox (Bowker's). A combined insecticide and fungicide for all leaf eating insects, blights and fungus troubles; it is a pasty substance, and needs only to be mixed with cold water. Per lb., 40c.; \$1.50 per 5 lbs.; 10 lbs., \$2.50; \$5.75 per 25 lbs.; 50 lbs., \$10.00; \$18.00 per 100 lbs.; 300 lbs., \$51.00.

Rat Corn. For destroying rats and mice in greenhouses, hotbeds, etc.; not poisonous to other animals, 25c., 50c. and \$1.00 per box.

Readeana Rose Bug Exterminator. Used for destroying rose bugs, green fly, mealy bug, blight, mildew, etc. Harmless to the most delicate plant. 4 oz., can, 25c.; 50c. per 8 oz.; 24 oz., \$1.00; \$4.00 per gal.

Scalecide. Used for the destruction of the San Jose Scale. Dilute at the rate of one gallon Scalecide to 20 gallons water. Scalecide does not clog nozzles, hose or pump, and is pleasant to use. Spray during the winter or early spring when the trees are dormant. Per qt., 60c.; \$1.45 per gal.; 5 gals., \$6.45; \$11.00 per 10 gals.; 30 gals., \$27.00; \$39.50 per 50 gals.

Scale Destroyer (Soluble Oil). For San Jose Scale; 1 gal. dilutes to 20 gals. water. Per qt., 65c.; \$1.00 per ½ gal.; gal., \$1.60; \$7.00 per 5 gals.

Shoo Fly. For keeping flies off cattle and horses; used with a spray or a sponge; the cattle and horses are either sprayed or rubbed with the preparation in the morning before being put in the field or out to their day's work. Per qt., 50c.; \$1.35 per gal.

Slug Shot. The standard remedy for currant worms, rose slugs, cabbage worms, and almost any soft-shelled insects that infest the vegetable or flower garden. Per 1-lb. canister, 18c.; 60c. per 5 lbs.; 10 lbs., \$1.15; \$2.75 per 25 lbs.; 100 lbs., \$10.50; full barrel lots (about 250 lbs.), 9½c. per lb.

Soap Spray. An all around outdoor and greenhouse insecticide. Per pt., 65c.; \$1.00 per qt.; gal., \$3.00; \$12.00 per 5 gals.; 10 gals., \$22.50.

Sodium Cyanide. (See Cyanegg.)

Sulco V. B. Will control San Jose and other scale insects, and many species of plant lice and fungus diseases. Pt., 35c.; 60c. per qt.; ½ gal., \$1.10; \$2.00 per gal.; 5 gal., \$7.00.

Sulphate of Copper. For destroying fungus diseases of all kinds; also used in making Bordeaux mixture, and for spraying potato vines in connection with Paris Green. Where used as a Bordeaux mixture it requires four pounds sulphate of copper to 6 pounds lime, which is diluted in 50 gallons of water. Per lb., 15c.; 65c. per 5 lbs.; 10 lbs., \$1.20; \$2.75 per 25 lbs.; 100 lbs., \$10.00.

Sulphur. Used principally in greenhouses for checking mildew. It is also used as a preventive and cure for San Jose Scale, when it is used in connection with lime and salt. Per lb., 10c.; 45c. per 5 lbs.; 10 lbs., 85c.; \$2.00 per 25 lbs.; 100 lbs., \$7.50.

Sulphur Candles. For fumigating in sick-rooms, also in conservatories and greenhouses. Large, 30c. each; per doz., \$3.00; small, 20c. each; per doz., \$2.00.

Thrip Juice (Hammond's No. 2). This preparation is very effective against aphid, red spider, mealy bugs and sucking insects generally. Per pt., 85c.; \$1.40 per qt.; gal., \$4.25.

Tobacco Dust (for dusting only). Excellent for lettuce and other plants to destroy soft, creeping insects. Per lb., 10c.; 40c. per 5 lbs.; 10 lbs., 60c.; \$1.35 per 25 lbs.; 50 lbs., \$2.50; \$4.75 per 100 lbs.

Tobacco Dust (special dusting or fumigating). A specially prepared article. Per lb., 10c.; 45c. per 5 lbs.; 10 lbs., 85c.; \$1.75 per 25 lbs.; 50 lbs., \$3.25; \$6.00 per 100 lbs.

Tobacco Soap (Sulpho). A combination of tobacco extract and sulphur; fine for washing and spraying plants; dissolve in warm water. Per 3 oz., 15c.; 25c. per 6 oz.; 10 lbs., \$3.50.

Tobacco Stems (Fresh). Used principally for fumigating and under benches in greenhouse. They may also be steeped in hot water and used as a spray. Per lb., 10c.; 40c. per 5 lbs.; bushel, \$1.00; \$1.75 per bbl. sack; large bales at 2½c. per lb.; ½ ton \$17.00; \$32.00 per ton.

Tobacco Stems (Shredded). For mulching flower beds, top dressing lawns, etc.; acts as a fertilizer as well as an insecticide. Per 5 lbs., 25c.; 45c. per 10 lbs.; 25 lbs., \$1.00; \$1.75 per 50 lbs.; 100 lbs., \$3.00; \$13.00 per 500 lbs.; 1000 lbs., \$25.50; \$50.00 per ton.

Tree Bands (Standard). Made of heavy waterproof paper, with a sticky, repellent material under the canopy. Protects trees and large shrubbery against worms, caterpillars, etc.; easily applied. Per 25 foot roll, \$1.50; \$6.00 per 100 foot roll.

Tree Tanglefoot. A paste preparation for painting around the trunks of trees, in the form of a band. Caterpillars and other crawling pests cannot get over it. Per lb., 50c.; \$2.40 per 5 lbs.; 10 lbs., \$4.50; \$8.75 per 20 lbs.; 25 lbs., \$9.25.

Wilson's O. K. Plant Spray. A powerful yet harmless and efficient insecticide for aphid, red spider, mildew, scale, etc., for inside and outside spraying. Per gal., \$3.25.

Worm Killer (Michell's) (for earth worms). This is a powder and is distributed over a given surface and soaked with water, which causes the worms to come to the surface, where they may be scooped up readily and further destroyed. It acts as a fertilizer as well as worm destroyer. Per 112 lb. bag, \$7.50; \$35.00 per 560 lbs.; 1120 lbs., \$65.00; \$120.00 per 2240 lbs.

Worm Eradicator (Reade's Electric). This has been found to effectually destroy worms in greenhouse benches and in potted plants, or for outdoor use in the flower and vegetable garden, or among trees. \$1.00 per 24 oz.; gal., \$4.00.

Zenke's Insecticide. (See insecticide.)

Zenoleum. A germicide and disinfectant. Endorsed by forty-four State Experiment Stations and Agricultural Colleges, and the leading live stock men of America. Zenoleum is a concentrated solution of coal tar. It mixes with hot or cold water. It will penetrate deeper and more rapidly than any other disinfectant. Per ½ pt., 35c.; 75c. per qt.; ½ gal., \$1.25; \$2.00 per gal.; 5 gal. can, \$9.50.

Lamps for Vaporizing Nicotine Solutions. 85c. each.

MICHELL'S HIGH GRADE FERTILIZERS

PLEASE NOTE.—No smaller quantity of Fertilizer than here offered can be supplied.



All prices on Fertilizers subject to market changes.

Acid or Rock Phosphate (14%). Apply 1000 lbs. per acre. Used for mixing with other fertilizers to increase the phosphoric acid analysis. In 200 lb. sacks only. \$3.00 per 200 lbs.; ½ ton, \$12.00; \$22.00 per ton.

Alphano Inoculant. A soil bacteria used in growing legumes, thereby increasing the crop and enriching the soil. It comes in a finely powdered form, making it easy to use. 1-acre size (2 lbs.), \$1.00; per 10-acre size (20 lbs.), \$8.00.

Anti-Clover Fertilizer (Michell's). The use of this on golf courses and putting greens is highly recommended as it prevents the growth of white clover which is very unessential on golf courses. Analysis: Ammonia, 8%; phosphoric acid, 2%; potash, 1%; 200 lb. bags only. \$8.00 per 200 lbs.; 1000 lbs., \$37.00; \$72.00 per ton.

Ashes, Hard Wood. Apply 1000 lbs. per acre. Indispensable for all crops requiring potash; excellent for mixing with potting soil. For top dressing lawns and grass fields it is applied to best advantage either in very early spring or late fall. Per 25 lbs., 85c.; \$1.50 per 50 lbs.; 100 lbs., \$2.50; \$4.25 per 200-lb. bbl.; 1000 lbs., \$18.00; per ton, \$35.00.

Asparagus Fertilizer. A mixture that promotes the root and top growth. Apply 800 lbs. per acre. 25 lbs., \$1.00; \$1.75 per 50 lbs.; 100 lbs., \$3.00; \$5.25 per 200 lbs.; 1000 lbs., \$24.00; ton, \$42.50.



Alfalfa plant on left not inoculated. Plant on right inoculated with Mulford Culture for Alfalfa. All other conditions identical. This contrast speaks for itself.

Bacteria, Farmogerm. An extensively advertised preparation for inoculating legumes prior to sowing or planting. Be sure and state crop the Farmogerm is desired for when ordering. Price, trial size (for Beans, Peas and Sweet Peas), 50c.; 1-acre size, \$1.00; 3-acre size, \$2.50; 12-acre size, \$9.00.

Bacteria, Mulford Culture. For inoculating clovers and other legumes, such as beans, peas and such other plants that have blossoms similar in shape and form to the above named. When ordering please state for what crop

you desire to use it. 35c. per trial bottle; ¼ acre size, 75c.; \$1.50 per acre size; 5 acre size, \$5.00.

Bacteria, Standard Inoculating. For all legumes; increases the yield; enriches the soil; hastens maturity; improves feeding value. Please specify on your order for what crop you desire to use it, as there is a different strain for each legume. Trial size (supplied only for Garden Beans, Garden Peas and Sweet Peas), 25c.; 50c. per garden size; one acre size, 75c.



Blood (Dried). For indoor culture of flowering plants, like roses, carnations, etc., its chief element being nitrogen. One of the quickest acting fertilizers. 5 lbs., 60c.; \$1.00 per 10 lbs.; 25 lbs., \$2.00; \$3.50 per 50 lbs.; 100 lbs., \$6.75; \$13.00 per 200 lbs.

Blood Flour. Very finely bolted. 5 lbs., 65c.; \$1.10 per 10 lbs.; 25 lbs., \$2.25; \$4.00 per 50 lbs.; 100 lbs., \$7.25; \$14.00 per 200 lbs.

Bon Arbor. A concentrated chemical fertilizer to be used in liquid or powder form, according to directions on package. Dilute 1 lb. to 30 gals. water. 60c. per lb.; 5 lbs., \$2.75.

Bone (Coarse Ground). Apply 800 to 1000 lbs. per acre. Prepared from raw bone, exactly like bone meal, except that it is not so fine or quick in action; it is used for the same purpose. 200 lb. bags only. \$7.50 per 200 lbs.; 1000 lbs., \$35.00; \$65.00 per ton.

Bone Flour. Finely pulverized and bolted. Effective immediately. For rose growing this cannot be excelled. Rich in phosphoric acid and ammonia. Apply 600 lbs. per acre. 5 lbs., 50c.; 85c. per 10 lbs.; 25 lbs., \$1.50; \$2.75 per 50 lbs.; 100 lbs., \$5.00; \$8.50 per 200 lbs.; 1000 lbs., \$37.50; \$70.00 per ton.

Bone Meal (Michell's Special Grade). Unusually rich in nitrogen and phosphoric acid, the two principal plant foods. We recommend this especially for lawns, gardens and greenhouses, or any purpose where a high-class fertilizer counts. Apply 800 to 1000 lbs. per acre. 3 lbs., 25c.; 35c. for 5 lbs.; 10 lbs., 60c.; \$1.40 for 25 lbs.; 50 lbs., \$2.50; \$4.00 per 100 lbs.; 200 lbs., \$7.00; \$32.00 per ½ ton; ton, \$60.00.

Chrysanthemum Manure (Thomson's Special). Especially recommended and used by the leading private gardeners of England and America. Very highly concentrated. Per 28-lb. sack, \$4.00; \$7.00 per 56-lb. sack.

Clay's Fertilizer. An English chemical fertilizer, for forcing greenhouse plants and vegetables. It can be used in either dry or liquid form. 28 lbs., \$3.75; \$6.25 per 56 lbs.; 112 lbs., \$12.00.

Climax Lawn Sand. (See Lawn Sand, Page 191.)

Cotton Seed Meal. Apply 800 lbs. per acre. Exceedingly rich in potash and ammonia, making it excellent for use as a grass and grain fertilizer; for putting greens it is invaluable. 5 lbs., 35c.; 60c. for 10 lbs.; 25 lbs., \$1.25; \$2.25 for 50 lbs.; 100 lbs., \$4.00; \$34.00 per 1000 lbs.; ton, \$65.00.

Cow or Cattle Manure (Shredded). One sack of this is equal to one cartload of cow manure in regular form. Convenient to handle, making it possible for everyone to get this usually scarce article at all times. Especially suited for soil mixing, mulching and liquid manuring. Apply 1000 lbs. per acre. \$3.50 per 100 lbs.; 500 lbs., \$16.25; \$30.00 per 1000 lbs.; ton, \$55.00.

Cow or Cattle Manure (Pulverized). Thoroughly sterilized and weedless. Quick in action and especially desirable for pot plants, etc. \$3.50 per 100 lbs.; 500 lbs., \$16.25; \$30.00 per 1000 lbs.; ton, \$55.00.

Grass and Grain Fertilizer (Michell's). A splendid mixture for top dressing wheat, rye, timothy and grass fields. Apply 800 to 1000 lbs. per acre. 200 lbs. for \$5.00; \$23.00 per 1000 lbs.; per ton, \$42.50.

PLEASE NOTE.—No smaller quantity of Fertilizer than here offered can be supplied.

All prices on Fertilizers subject to market changes.

Grass Grower (*Michell's Odorless*). This is a complete balanced fertilizer for lawns, grass plots, fairways and putting greens. This fertilizer is complete in every way and will produce wonderful results. Analysis. Ammonia, 7%; phosphoric acid, 8%; potash, 1%. In convenient friction top cans 10 lbs. net, handy to have about for top dressing, \$1.00 each; 200 lb. bags, \$7.50; \$37.00 per 1000 lbs.; per ton, \$72.00.

Hog Manure (*Pulverized*). Put up and sold in 100-lb. bags only; splendid for forcing vegetables and flowering plants, increasing size and yield. Per 100 lbs., \$3.75; \$16.50 for 500 lbs.

Horn Shavings. Used principally for mixing in potting soil; is rich in ammonia; especially valuable in chrysanthemum growing. 5 lbs., 65c.; \$1.10 for 10 lbs.; 25 lbs., \$2.00; \$3.75 for 50 lbs.; 100 lbs., \$7.00.

Humus (*Alphano Prepared*). An excellent article to incorporate with poor soil in the garden, greenhouse or in potting plants. When used in garden work, the ground should be covered with $\frac{1}{2}$ to 2 inches of Humus and spaded in. Price, f. o. b. Philadelphia, 5 lbs., 35c.; 60c. for 10 lbs.; 25 lbs. for 90c.; \$2.75 per 100 lbs.; 500 lbs., \$12.00; \$18.00 per 1000 lbs.; 2000 lbs., \$32.50. F. o. b. Alphano, N. J., per ton in bags less carload lots, \$20.00 per ton; per ton in bags in carload lots (20 tons), \$16.00 per ton; per ton in bulk in carload lots about 30 tons, \$10.00 per ton.

Humus (*Natural*). Not a prepared or chemical fertilizer but pure vegetable Humus, that has been decayed. Excellent for top dressing lawns; especially adapted to golf course construction and compost for golf greens; also valuable for the garden and for pot plants. Price, in car lots only, \$6.00 per ton, f. o. b. Alphano, N. J.

Kainit (*Potash Salts*). Apply 800 to 1000 lbs. per acre. Excellent for potatoes, corn and other grains; also for top dressing asparagus beds, etc. 5 lbs., 30c.; 50c. per 10 lbs.; 25 lbs., 90c.; \$1.50 per 100 lbs.; 200 lbs., \$2.75; \$12.00 per 1000 lbs.; ton, \$22.00.

Land Plaster. Used for top dressing newly plowed land prior to harrowing and for sweetening the soil on lawns and fields; also used for mixing with Paris Green. Apply 1500 to 2000 lbs. per acre. 40c. for 10 lbs.; 25 lbs., 85c.; \$1.25 for 50 lbs.; 100 lbs., \$2.00; \$3.75 for 200 lbs.; $\frac{1}{2}$ ton, \$16.00; \$30.00 per ton.

Lawn Sand. A weed destroyer, as well as a fertilizer; contains a large percentage of nitrogen. Will be found very valuable for lawn use. For best results follow the directions on the package. $3\frac{1}{2}$ lb. tin, 75c.; \$1.35 for 7 lbs.; 14 lbs., \$2.50; \$4.00 per 28 lbs.; 56 lbs., \$6.50; \$12.50 per 112 lbs.

Lime (*Hydrated or Powdered*). This is a very fine article for distributing on grass. Promotes growth, gives the grass a rich color and has a tendency to prevent the growth of weeds. Apply one ton per acre. 45c. per 10 lb. box; 125 lb. sack, \$2.25; \$8.00 per 500 lbs.; 1000 lbs., \$14.00; \$27.00 per ton.

Limestone (*Pulverized*). For applying on sour or wornout soils at the rate of 1 ton per acre. Put up in 100-lb. bags. \$1.50 per bag; 500 lbs., \$6.00; \$10.00 per 1000 lbs.; ton, \$17.50.

Manure (*Fresh Horse, Stockyard and Cow*). At short notice we can usually supply first-class horse, cow and stockyard manure in carload lots only. Prices on request.

Muriate of Potash. Apply 100 to 150 lbs. per acre, usually with other fertilizers. Excellent for potatoes, corn, grains, etc. Analysis, equal to 50 per cent. actual potash. 5 lbs., 40c.; 70c. per 10 lbs.; 25 lbs., \$1.50; \$2.75 for 50 lbs.; 100 lbs., \$4.75; \$8.50 for 200 lbs.

Nitrate of Soda. Apply 100 to 150 lbs. per acre, mixing with land plaster or other fertilizers to render application more easy. Use only after plants are above ground. If used in liquid form dilute 2 ozs. to 1 gal. of water and do not apply oftener than twice a week. 5 lbs., 45c.; 85c. per 10 lbs.; 25 lbs., \$1.50; \$2.75 per 50 lbs.; 100 lbs., \$4.75; \$9.50 per 200 lbs.; 1000 lbs., \$45.00; \$80.00 per ton.

Phosphate (*Michell's High Grade*). For all vegetable crops, grains, grass, etc. Apply 800 to 1000 lbs. per acre broadcast. 5 lbs., 30c.; 55c. per 10 lbs.; 25 lbs., \$1.25; \$1.75 per 50 lbs.; 100 lbs., \$3.00; \$5.50 per 200 lbs.; $\frac{1}{2}$ ton, \$25.00; \$42.50 per ton.

Phosphate for Corn (*Michell's*). Apply 800 lbs. per acre. This contains the necessary ingredients to produce a bumper crop of either field or sugar corn. \$5.00 for 200 lbs.; per $\frac{1}{2}$ ton, \$21.00; \$38.00 per ton.

Plant Food (*Michell's*). A highly concentrated chemical fertilizer for house, garden or conservatory. Clean, odorless and producing early and abundant blossoms of rich and brilliant color, and healthy, luxuriant plants. Analysis: Nitrogen, $2\frac{1}{2}\%$; available phosphoric acid, 7%; potash, 2%. Per 5 oz. pkg., 20c.; 30c. per 12 oz. pkg. Allow for postage if wanted by mail.

Plant Life (*Zenke's*). A liquid plant food, tonic and fertilizer. It contains in concentrated form the elements of plant food in proper proportion for absorption by the plant. Per 8 oz., 25c.; \$3.25 per gal.

Potato Fertilizer (*Michell's*). Apply at the rate of from 800 to 1000 lbs. per acre. The principal fertilizer for potatoes in this section, being especially compounded for this purpose. 25 lbs., \$1.25; \$2.00 per 50 lbs.; per 100 lbs., \$3.00; \$5.50 per 200 lbs.; per $\frac{1}{2}$ ton, \$25.00; \$45.00 per ton.

Poudrette (*Native Guano*). For top dressing lawns, vegetable and flower gardens. 5 lbs., 30c.; 50c. per 10 lbs.; 25 lbs., \$1.00; \$2.25 per 100 lbs.; 200 lbs., \$4.25; \$17.50 per $\frac{1}{2}$ ton; ton, \$34.00.

Poultry Manure (*Pulverized*). A splendid fertilizer rich in ammonia and nitrogen, very quick in action, but should be used cautiously; in 100-lb. bags only, \$3.50.

Salt. For asparagus beds and putting on walks and roads to kill weeds. Apply 800 lbs. per acre in early spring. 25 lbs. for 75c.; \$1.25 for 50 lbs.; \$2.00 per 100 lbs.; 200 lbs., \$3.25; \$13.00 per 1000 lbs.; ton, \$25.00.

Sheep Manure (*Wizard Brand*). Apply 1000 lbs. per acre. One of the most extensively used of animal manures. The analysis shows it to be a perfectly balanced plant food. For garden, lawn or greenhouse use, nothing surpasses sheep manure; it is clean and easily handled, besides giving immediate results. 2 lbs., 25c.; 40c. per 5 lbs.; 10 lbs., 65c.; \$1.25 per 25 lbs.; 50 lbs., \$2.00; \$3.50 per 100 lbs.; 500 lbs., \$16.50; \$30.00 per 1000 lbs.; per ton, \$55.00.

Soot (*Imported Scotch*). This is used principally for bringing a good healthy color into the foliage of chrysanthemum and other greenhouse plants. Also destroys insects and grubs that work on top of and underneath the surface. 5 lbs., 75c.; \$1.25 per 10 lbs.; 25 lbs., \$2.00; \$7.50 per 112 lbs.

Stim-U-Plant. A plant food in tablet form; contains highly concentrated, immediately available forms of plant food for use in stimulating all fruit, flower, vegetable and ornamental plants, and may be used in tablet or in liquid form. Per pkg. of 30 tablets, 25c.; 75c. per pkg. of 100 tablets; 1000 tablets, \$3.50.

Sulphate of Ammonia. Apply 75 to 100 lbs. per acre only with other fertilizers deficient in nitrogen. A valuable fertilizer for all plants in which a large leaf development or rapid growth is desired; will stimulate growth almost immediately. Analysis equal to 25% of ammonia. 5 lbs., 50c.; 90c. per 10 lbs.; 25 lbs., \$1.85; \$3.50 per 50 lbs.; 100 lbs., \$6.25; \$12.00 per 200 lbs.

Sulphate of Ammonia (*Arcadian*). A concentrated nitrogenous top dressing fertilizer, entirely soluble and immediate in action. Analysis: $25\frac{1}{4}\%$ ammonia or $20\frac{1}{4}\%$ nitrogen. Price upon application.

Sulphate of Potash. Apply 100 to 125 lbs. per acre, usually with other fertilizers. On account of its great strength it must be used judiciously. Valuable for root and grain crops. Analysis equal to 50% of actual potash. 5 lbs., 45c.; 85c. per 10 lbs.; 25 lbs., \$1.50; \$2.75 per 50 lbs.; 100 lbs., \$5.00; \$9.00 per 200 lbs.

Tankage. This is usually applied to plants such as roses, etc., under glass. It is similar to dried blood. 5 lbs., 35c.; 60c. per 10 lbs.; 25 lbs., \$1.25; \$2.00 per 50 lbs.; 100 lbs., \$3.75; \$6.75 per 200 lbs.

Thomson's Special Flower, Vegetable and Vine Manure. Imported from England, this excellent chemical fertilizer is a reliable food and stimulant for every fruit-bearing plant, also foliage and flowering plants and vegetables of all descriptions. So compounded as to combine stimulating with lasting effects. 28 lb. bag, \$3.00; \$5.75 per 56 lbs.; 112 lbs., \$9.50.

Tobacco Stems. For fumigating, mulching and fertilizing, these are invaluable. The chief fertilizing element in them is the potash. 40c. for 5 lbs.; per bu., \$1.00; \$1.75 per bbl. sack; in large bales at $2\frac{1}{2}$ ¢ per lb.; per $\frac{1}{2}$ ton, \$17.00; \$32.00 per ton.

Tobacco Stems (*Shredded*). For mulching flower beds, plant benches, top dressing, lawns, etc.; acts as an insecticide as well as a fertilizer. 5 lbs., 25c.; 45c. per 10 lbs.; 25 lbs., \$1.00; \$1.75 per 50 lbs.; 100 lbs., \$3.00; \$13.00 per 500 lbs.; 1000 lbs., \$25.50; \$50.00 per ton.

Wheat Fertilizer. For grass and grain crops. Apply 800 lbs. per acre. \$5.00 per 200 lbs.; $\frac{1}{2}$ ton, \$22.50; \$42.50 per ton.

Wood Ashes. See ashes at top of opposite page.

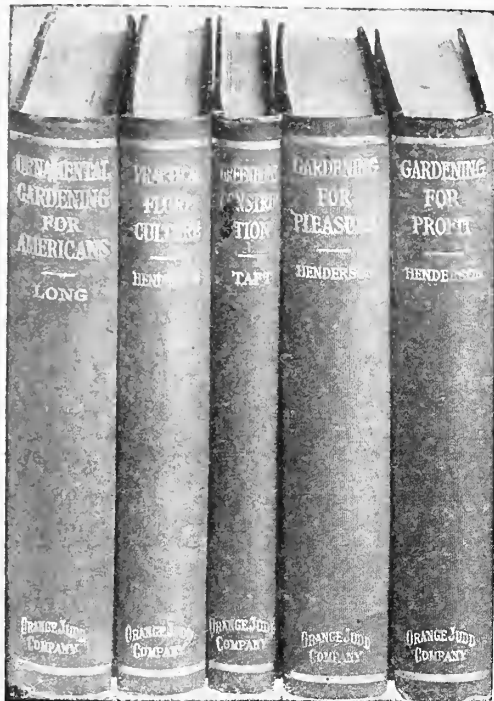

STANDARD CYCLOPEDIA OF HORTICULTURE By L. H. BAILEY

Freshly written in the light of the most recent research and experience, largely by experts in their various specialties. Six large volumes; more than 3600 pages; 24 full page color plates; 96 full page sepia half tones; more than 4000 text engravings. Sold only in complete sets, price \$40.00.

BOOKS ON FLOWERS, VEGETABLES, Etc.

Alfalfa (F. D. Coburn).....	\$0.90
Agriculture, The Principles of (Bailey). A text-book.....	1.80
Asparagus (Hexamer). Its culture for home; for market.....	.90
Bean Culture (Sevey).....	.90
Berry Book (Biggle).....	.50
Botany (Wright). Cloth.....	.75
Bulbs and Tuberous Rooted Plants (Allen).....	2.00
Cabbage, Cauliflower and Allied Vegetables (Allen).....	.90
Canning and Preserving. Mrs. S. S. Rorer.....	1.00
Celery Culture (Beattie).....	.90
Chrysanthemum Manual (Smith). A complete guide.....	.60
Clovers and How to Grow Them (Shaw).....	2.00
Commercial Carnation Culture. An up-to-date book.....	1.75
Commercial Floriculture, 555 pages. (By Fritz Bahr).....	5.00
Farm and Garden Rule Book (Bailey).....	3.00
Farm Grasses of the United States (Spillman).....	1.75
Farmers' Account Book (G. A. Boehne). Very practical.....	3.00
Fertilizers (Gregory). How to Make and When to Use.....	.50
Flowers, How to Grow Them (Rexford).....	1.00
Forcing Book (Bailey).....	2.00
Four Seasons in the Garden (Rexford). Profusely illus.....	1.75
Fruit Culturist, American (Thomas).....	3.50
Fruit Garden (Barry).....	2.25
Fruits and Vegetables Under Glass.....	5.00
Garden Book, The Practical (Hunn and Bailey).....	1.75
Garden Guide. A complete treatise on the garden. Cloth, \$1.65; Paper, \$1.10.	
Gardening for Pleasure. A guide to the amateur in the fruit, flower and vegetable garden.....	2.00
Gardening for Profit. On vegetable gardening.....	2.00
Garden-Making (Bailey). Tells how to utilize grounds.....	2.25
Grape Culturist (Fuller). Best work on the hardy grape.....	2.00
Greenhouse Construction (Taft).....	2.25
Greenhouse Management (Taft).....	2.25
Handbook of Plants (Henderson). A dictionary on plants.....	3.50
Hardy Garden Book, A Woman's (Ely).....	2.00
Home Floriculture (Rexford). A guide for the amateur.....	1.75
Home Fruit Grower. Cloth, \$1.65; Paper.....	1.10

BOOKS ON FLOWERS, VEGETABLES, Etc. (Continued)

How to Grow Roses (Robert Pyle).....	\$1.25
How to Grow Vegetables. A practical hand-book and plant- ing table for the home garden (Allen French).....	2.00
How to Plan the Home Grounds (Parsons).....	1.25
Johnson's Gardeners' Dictionary.....	6.50
Landscape Gardening, Practical (Robt. B. Cridland).....	2.65
Landscape Gardening (Maynard).....	2.50
Melon Culture (Troop).....	.90
Milady's House Plants. Cloth, \$1.10; Paper.....	.85
Mushroom Culture (Duggar).....	2.00
Mushrooms, How to Grow (Falconer).....	1.60
Onion Culture, The New (Greiner).....	.90
Onions, How to Raise Them Profitably.....	.40
Orchard Book (Biggle).....	.50
Ornamental Gardening (Long).....	2.00
Peanut Culture (Jones).....	.50
Peas and Pea Culture (Sevey).....	.90
Plant Culture (Oliver and Hottes).....	3.65
Plant Propagation, Practical (Hottes).....	2.15
Practical Book of Outdoor Rose Growing (Thomas).....	7.50
Practical Floriculture (Henderson).....	2.00
Principles and Practice of Pruning (Kains).....	2.50
Principles of Fruit Growing (Bailey).....	2.50
Potato, The (Fraser).....	1.00
Pruning Manual (Bailey).....	2.50
Rhubarb Culture, The New (Morse and Fiske).....	.90
Right Use of Lime in Soil Improvement (Agee).....	1.25
Rose Culture (Ellwanger). A standard book on Roses.....	1.75
Small Fruit Culturist (Fuller).....	1.60
Soils (Burkett).....	1.75
Spraying Crops (Weed).....	.90
Strawberry Culture (Fuller). Contains all information.....	.40
Study of Corn, The (Shoesmith).....	.90
Sweet Corn Culture (Wilkinson).....	1.00
Sweet Pea Culture (Michell). Free with orders.	
Sweet Peas for Profit.....	1.75
Sweet Potato Culture (Fitz).....	.90
The Small Country Place (Maynard). Well illustrated.....	1.75
The Spraying of Plants. Gives the principles and practice of the application of liquids and powders to plants for destroying insects and fungi. By Lodeman.....	1.00
Tomato Culture (Tracy).....	.90
Vegetable Forcing (Watt's).....	2.50
Vegetable Gardening, Principles of (Bailey).....	4.00
Vegetable Gardening (Watts).....	2.50
Violet Culture (Galloway).....	1.75
Violet Culture (Saltford).....	.30
Water Gardening, Book of (Bisset).....	3.50
Wheat Culture (Curtiss).....	.50
Wild Flower Book for Young People (Lounsberry).....	2.50

BOOKS ON POULTRY AND ANIMALS

A. B. C. of Bee Culture (Root).....	\$3.00
Artificial Incubating and Brooding. 96 pages, illustrated.....	.75
Asiatics, Brahmas, Cochins and Langshans. 100 pages.....	.75
Chick Book, The. Tells how to obtain good hatches.....	.75
Chickens, All About (Johnson). Cloth, \$1.00; paper.....	.40
Diseases of Poultry (Salmon).....	1.00
Dog, The (Maxtee). Cloth, 60c.; paper.....	.40
Ducks and Geese. Give all details. 104 pages.....	.75
Egg Record and Account Book. 32 pages.....	.30
200 Eggs per Year per Hen.....	.75
Leghorns. The best mating schemes clearly described.....	1.10
Minorcas (Northrup).....	.75
Orpingtons, The.....	.75
Plymouth Rocks, The. Barred, Buff and White. Special- ists describe mating and breeding methods. 160 pages.....	1.10
Poultry Houses and Fixtures, 96 pages.....	1.00
Poultry Production (Lippincott).....	3.00
Profits in Poultry.....	1.60
Rhode Island Reds (Hale).....	.75
Standard of Perfection. Explains all the scoring points.....	2.60
Turkeys. Every detail of the business explained. 96 pages.....	.75
Wyandottes, The (Grevenstedt). All strains. 160 pages.....	1.00

Make Your Garden Pay

IT COSTS NO MORE—takes no more work—to get maximum results out of your lawn and garden-making than is expended on half-way satisfactory and unprofitable planting. ☐ The time you lose—the seed you waste—your failures and disappointments—will more than pay for feeding your soil all that it needs to make the flowers bloom luxuriantly, grow vegetables of unusual size and flavor, and to have fruits that will delight your table. You can have all of these by using—

WIZARD Sheep Manure

TRADE BRAND MARK

PULVERIZED—convenient—every weed seed destroyed—a natural fertilizer that supplies both the plant food and humus your soil needs in the ideal form for Nature to work with.

Every experienced gardener uses all the manure he can get because nothing else puts so much life and fertility into his soil. Sheep Manure is the richest and best of all animal manures and WIZARD gives you the equivalent of a whole wagon load of stable manure in a bag.

WIZARD Sheep Manure comes from the Great Western sheep feeding stations and is prepared through an extensive process of drying, sterilizing and grinding into a convenient natural fertilizer. Every weed seed is destroyed by the intense heat of the driers and this makes WIZARD safe for the finest landscape work.

Use WIZARD BRAND just once and know the convenience of it and the success it will bring to your gardening and you will never plant again without it. Feed your soil liberally.

For Lawn Making

WIZARD Sheep Manure is the most effective and satisfactory of all lawn fertilizers. It promotes a strong, healthy turf, of beautiful color—is easily applied by anyone, and brings no weed seeds. Use 10 pounds for each 100 square feet, scattered one-half before spading and the remainder immediately after. Rake down to a smooth finely pulverized surface. Then sow one-half your seed from north to

south, remainder from east to west to obtain uniform distribution, roll or press down firmly with back of a spade, water thoroughly and results will surprise you.

An old lawn should have a dressing of 6 to 8 pounds of WIZARD to each 100 square feet, applied broadcast in the early spring and fall because the turf absorbs all its nourishment out of the shallow top soil very rapidly. This treatment, with an occasional addition of some new seed, will insure an attractive lawn year after year and avoid the unsightly appearance of the old time manure littered grounds.

Flower Gardens

The best manure you can use. Nothing will make such colors and foliage. It's just what Nature needs to make big, strong, healthy plants. Dig it deeply into garden soil and then mix a small handful with the soil in planting each bulb, and more, depending upon size in setting shrubs, vines and trees. Rake it into top soil before planting seed in rows or hills. Ten pounds for each 100 square feet is all you require.

For planting in pots or window boxes, use one pound of WIZARD thoroughly mixed with each cubic foot of earth—or a pound in 5 gallons of water set over night for liquid dressing. WIZARD is far better than a chemical stimulant because it is a natural plant food.

Vegetables and Fruits

Used on everything in the vegetable garden the same as above, WIZARD forces quick, rapid growth, improves the color and size, makes crisp, juicy fruits and increases production wonderfully. WIZARD Sheep Manure is Nature's fertilizer and it does make Nature hustle. A light side dressing during the growing season can be worked in along the row or around the hills while cultivating. Small fruits, berries, etc., and the larger vegetable plants respond wonderfully for this extra feeding.

Conveniently Packed

WIZARD comes in all sizes for all needs. As easy and clean to handle as grain. Use it for all purposes from a potted plant to a field of any acreage.

Prices—2 lbs. 25c; 40c per 5 lbs.; 10 lbs. 65c; \$1.25 per 25 lbs.; 50 lbs. \$2.00; \$3.50 per 100 lbs.; 500 lbs. \$16.50; \$30.00 per 1000 lbs.; ton, \$55.00.



WIZARD
TRADE BRAND MARK
Cow
Manure

Shredded—for mulching and top dressing. Pure Cow Manure from Chicago Stock Yard cattle pens. Dried and sterilized by the WIZARD direct heat process and packed in coarse shredded form. Cow manure is especially valuable in light sandy soil and for roses, ferns, etc., because it is a slow, cool acting manure. Largely used in preparing soil for growing flowers and vegetables in

greenhouses and for top dressing benches. Excellent for liquid manuring.

Pulverized—is shredded Cow Manure continued through the grinding process to produce a finely ground product. Cow Manure is packed in 100-pound bags only.

Prices—\$3.50 per 100 lbs.; 500 lbs. \$16.25; \$30.00 per 1000 lbs.; ton \$55.00.



**MICHELL'S TOP NOTCH
LAWN GRASS SEED**

The best in existence

4 Quarts, \$1.50 Per Peck, \$2.75
Bushel (25 lbs.), \$10.00

*(See pages 38 to 41 of this catalog for other
Grass Seed offers.)*

HENRY F. MICHELL CO. 518-516 MARKET ST. PHILA., PA.